

HOLOCAUST HANDBOOKS · VOLUME 26

# THE GAS VANS

**A CRITICAL INVESTIGATION**



**SANTIAGO ALVAREZ · PIERRE MARAIS**

PUBLISHED BY CASTLE HILL PUBLISHERS

# THE GAS VANS – A CRITICAL INVESTIGATION



**Santiago Alvarez**

**Pierre Marais**

# **The Gas Vans**

**A Critical Investigation**



**Castle Hill Publishers**

**P.O. Box 243, Uckfield, TN22 9AW, UK**

**Reprint of the first edition, November 2016**



**HOLOCAUST HANDBOOKS, Volume 26:**

Santiago Alvarez:

*The Gas Vans: A Critical Investigation.*

With major contributions by Pierre Marais.

Corrected reprint of the first edition of September 2011.

Uckfield, UK: CASTLE HILL PUBLISHERS

P.O. Box 243, Uckfield, TN22 9AW, UK

ISBN10 (print): 1-59148-164-3

ISBN13 (print): 978-1-59148-164-5

ISSN: 1529-7748

© 2011 Santiago Alvarez

Set in Times New Roman

Distribution:

Castle Hill Publishers

P.O. Box 243, Uckfield, TN22 9AW, UK

shop.codoh.com

[www.HolocaustHandbooks.com](http://www.HolocaustHandbooks.com)

Cover: Top: truck equipped with a producer-gas generator (see page 102). Left: moving truck found in Poland after the war, for decades falsely claimed to have been a “gas van” (see pages 33f., 275f.). Right: made-up drawing of an alleged “gas van” following testimony (see page 278). Background bottom: section of Document 501-PS (see page 281).





3.7.2.2.	LG Karlsruhe, Verdicts of 15 Dec. 1949 & 7. Oct. 1951 .....	178
3.7.2.3.	LG Wiesbaden, Verdict of 24 Mar. 1952 .....	179
3.7.2.4.	LG Köln, Verdict of 20 June 1953 .....	180
3.7.3.	From 1960 to 1964 (2 trials).....	184
3.7.3.1.	LG Karlsruhe, Verdict of 20 Dec. 1961 & 13 Dec. 1963.....	184
3.7.3.2.	LG Koblenz, Verdict of 21 May 1963 & 10 Nov. 1965 .....	186
3.7.3.3.	Interrogations of August Becker.....	188
3.7.4.	From 1965 to 1969 (11 trials).....	191
3.7.4.1.	LG Bonn, Verdicts of 30 Mar. 1963 & 23 July 1965 .....	191
3.7.4.2.	LG Kiel, Verdict of 26 Nov. 1965 .....	203
3.7.4.3.	LG Wuppertal, Verdicts of 30 Dec. 1965 & 13 Dec. 1967.....	204
3.7.4.4.	LG Frankfurt/M., Verdict of 12 Mar. 1966 .....	205
3.7.4.5.	LG Hannover, Verdict of 7 June 1966.....	207
3.7.4.6.	LG Stuttgart, Verdict of 15 Sep. 1967 .....	215
3.7.4.7.	LG Stuttgart, Verdict of 11 June 1968.....	220
3.7.4.8.	LG Dortmund, Verdict of 16 Jan. 1969 .....	221
3.7.4.9.	LG Kiel, Verdict of 11 Apr. 1969.....	223
3.7.4.10.	LG Darmstadt, Verdict of 18 Apr. 1969 & 23 Dec. 1971.....	226
3.7.4.11.	LG Kiel, Verdict of 28 Nov. 1969.....	228
3.7.5.	From 1970 to 1974 (6 trials).....	230
3.7.5.1.	LG Frankfurt/M., Verdict of 19 Mar. 1971 .....	230
3.7.5.2.	LG München I, Verdict of 22 Mar. 1972.....	231
3.7.5.3.	LG München I, Verdict of 14 July 1972.....	231
3.7.5.4.	LG München I, Verdict of 29 Mar. 1974.....	232
3.7.5.5.	LG Kiel, Verdict of 14 June 1974.....	233
3.7.5.6.	LG München I, Verdict of 15 Nov. 1974.....	234
3.7.6.	From 1975 to now (1 trial) .....	236
3.7.6.1.	LG München I, Verdict of 19 Dec. 1980 .....	236
3.8.	Gas Vans during Communist East German Trials.....	238
3.8.1.	General Remarks .....	238
3.8.2.	LG Berlin, Verdict of 14 Aug. 1978.....	241
3.8.3.	LG Karl-Marx-Stadt, Verdict of 11 June 1976.....	242
3.8.4.	LG Karl-Marx-Stadt, Verdict of 2 Dec. 1971.....	242
3.8.5.	LG Neubrandenburg, Verdict of 22 Feb. 1961.....	243
3.8.6.	LG Greifswald, Verdict of 3 July 1952 .....	243
<b>4.</b>	<b>Critical Summary of Witness Testimonies.....</b>	<b>245</b>
4.1.	The Witness Problem.....	245
4.2.	Claimed Features of the Vehicles .....	253

4.2.1. Introduction .....	253
4.2.2. Vehicle Models.....	254
4.2.3. General Appearance .....	255
4.2.4. Capacity.....	259
4.2.5. Duration of the Gassing Procedure.....	260
4.2.6. Poison Source .....	261
4.2.7. Gassing Procedure.....	262
4.2.8. The When, Where, and How Many .....	264
4.2.9. Conclusion.....	266
4.3. A Hypothesis on the Origin of “Gas Van” Claims .....	268
<b>5. Conclusions .....</b>	<b>271</b>
<b>6. Appendices .....</b>	<b>275</b>
Appendix 1: Images of Alleged “Gas Vans”.....	275
Appendix 2: The Becker Letter .....	281
Version A.....	281
Version B .....	285
Version C .....	287
Version D.....	288
Appendix 3: The Telegrams of Document 501-PS .....	289
Appendix 4: Dossier R 58/871 f°1, BAK .....	295
Letter of 26 March [194]2 .....	296
Translation & Remarks .....	297
Memo of 27 April 1942 .....	299
Translation & Remarks .....	306
Letter of 30 April 1942.....	312
Translation & Remarks .....	314
Letter of 14 May 1942 .....	316
Translation.....	317
Memo of 5 June 1942 (Just document).....	318
Memo and Letter of 23 June 1942 .....	323
Translation & Remarks .....	326
Juxtaposition of Two Documents.....	328
Letter of 18 September 1942 .....	330
Translation.....	331
Letter of 24 September 1942 .....	332
Translation.....	333
Appendix 5: Published Versions of the Just Document .....	334
Appendix 6: The Turner Letter .....	339
Translation.....	341
Appendix 7: <i>Einsatzgruppen</i> Report February 1942.....	343
Appendix 8: Special Vehicles of the German Army .....	346

Appendix 9: Interrogation Protocol of Witness Falborski..... 349  
    Translation..... 351

Appendix 10: Correspondence ..... 354

    Letter on the “Gas Vans” of Mauthausen ..... 354  
        Translation and Comments by P. Marais..... 355

    Letter by Mathias Beer to Pierre Marais ..... 362  
        Translation and Comments by P. Marais..... 364

    Letter by the Town of Konin to P. Marais ..... 370  
        Translation..... 370

    Letter by Auschwitz Museum (Poland) ..... 371  
        Translation..... 372

    Two Letters by Yad Vashem, Jerusalem ..... 373

    Photograph of the Chelmno Memorial ..... 375

    Letter by Steyr-Daimler-Puch to P. Marais ..... 376  
        Translation..... 377

Appendix 11: Drawings of “Gas Vans” ..... 378

**Bibliography ..... 381**

**Index of Names..... 387**





## Preface

The present study is the result of a confluence of a number of coincidences. As a matter of fact, its author never intended to write a book on the topic. He merely wanted to translate the book written by another author, and maybe edit it and update it a little where required. But that was not meant to be.

At the beginning there was the idea in early 2010 of translating into English Pierre Marais' French study *Les camions à gaz en question* (*The gas trucks scrutinized*), which had been published as early as 1994. This was meant to fill a gap in the *Holocaust Handbooks Series*, which so far did not have a monograph on the topic of the elusive "gas vans." Marais' study had appeared in a slightly revised German edition in 2009, and the current author was supplied with both the German translation as well as the French original. The text part itself had only some 100 generously formatted pages, and together with the recent updates prepared for the German edition, it looked like a project which could be accomplished swiftly, or so I thought.

Although initially by far no expert regarding the "gas vans" of the Third Reich, I had read several papers about this issue in the past permitting me to have a fairly good grasp of the state of the art. Hence, while translating Marais' work, I noticed numerous errors of facts, flawed and missing arguments, and, worse still, so many omissions of important documentary and anecdotal material, a great deal of which had become generally accessible only during the past 15 years, that I decided to give it a complete work over. Well, the more I worked on it, the more material turned up, so I ended up both increasing the book's volume by at least 100%, and rewriting, replacing or even deleting sizeable sections of Pierre's own text, which had become in need of revision and updating due to the added content and the many corrections.

At what I thought was the end of my editing efforts, I had in front of me a book that by 80% of its content was no longer Pierre's, but mine, and in which the parts that still were Pierre's at times read like alien remnants clearly written in the style of a different author and sometimes

awkwardly misplaced by the book's new structure. There could be no doubt that this would have to be smoothed out as well.

Under these circumstances, could the book still be presented to the author – or the public – as a translation of his work? Hardly. Would he accept all the changes made? Well, I was afraid to ask, and when getting in touch with Pierre's literary agent, he balked and suggested to not even submit this typescript to the then 90 year old Monsieur Marais, as he might have a hard time getting over this unscrupulous gutting and rewriting of his work. So the decision was made to make the rewrite complete and publish it under my name instead.

Yet in spite of all the rewriting done, this present book still owes a lot to Pierre's original work. First it is the very reason for its existence. Next, some of the basic structure of this book still follows Pierre's lead, and many of his arguments can still be found in it, even if they have been rearranged, rephrased, and at times reevaluated. And last but not least, Pierre's book was a trail blazer at its time, a foundation upon which the present study erects its larger, more thoroughly argued edifice. Pierre's book has been my stepping stone to the present study; his tome is the giant, the pioneer work of the first hour, without which this present book would not be.

Although this book may be regarded as a clear improvement in comparison to Pierre's work – a natural progress to be expected after almost two decades have passed – it is still far from complete, as much archival material held by the *Zentrale Stelle* in Ludwigsburg, Germany, is currently difficult, if not impossible, to access by critical researchers due to German censorship laws. Hence any of this study's conclusions must necessarily be considered provisional in character, and the discussion will remain open.

In addition to Pierre Marais, the present study owes much to the support by Thomas Kues, who tirelessly supplied me with all kinds of documents, some of them on my request, but also many which had been hitherto unknown to me.

Carlo Mattogno helped to improve the book as well by critically reading an earlier version of it and indirectly by his own research for his book on the Chelmno camp, from which the present book profited considerably.

I also thank all my other helpers, who for safety reasons will remain unnamed.

## Introduction

When it comes to the “Holocaust,” the alleged mass murder of European Jews by the Third Reich, most people think they “know.” Of course we all “know” that it happened. We “know” that six million died. We “know” that the Nazis pushed the Jews into the gas chambers and gas ovens, that they burned them, dead or alive, in gigantic crematories and on huge pyres. Our knowledge is so certain that anyone uttering disbelief is swiftly ostracized. In many countries people even call the police and have doubters arrested, prosecuted, and sent to prison. He who doubts what everybody knows to be true must be evil, indeed.

Most readers perusing the above sentences might not even notice that it contains a typical error, a falsehood even acknowledged by orthodox historians. This error has to such a degree become a fixed part of the cliché which we consider to be “knowledge” that it passes unnoticed.

There were no gas ovens.

The term makes no sense.

Mainstream historians claim that there were gas chambers on the one hand, designed to quickly asphyxiate hundreds, if not thousands of people at a time within mere minutes.<sup>1</sup> On the other hand everybody agrees that there were crematory ovens, designed to reduce deceased camp inmates to ashes (although the inmates’ cause of death and the crematories’ capacities are disputed<sup>2</sup>). In the mind of the public at large, though, gas chambers and crematory ovens have merged to some ominously sounding “gas ovens.” The public discourse about the Holocaust is replete with that nonsensical term, even though what it describes never existed.

So much about “we know.”

---

<sup>1</sup> Revisionists contest that notion, though, see for instance: Mattogno/Graf 2005, Mattogno 2004a&b; Mattogno 2005a&b, Graf/Kues/Mattogno 2010; Rudolf 2011; Mattogno 2010, 2011a.

<sup>2</sup> On the only existing scientific-technical study of the crematories in Auschwitz see Mattogno 2011b.

Listing and explaining all the false clichés prevailing in the public about the “Holocaust” would fill a separate book, so I will abstain from doing it here. The point I was trying to make is that, although we all have some basic grasp about what is meant by “the Holocaust,” most people are quite unfamiliar with even general aspects of the topic.

While gas chambers dominate the public’s mind when the specter of the “Holocaust” is raised, “gas vans” are usually absent from the discourse. What percentage of the general populace has ever heard that the Nazis are said to have deployed mobile gas chambers as well, which historians usually call “gas vans”?

This lack of knowledge is excusable, because even in orthodox historiography the “gas vans” have played only a minor role. To this date no monograph has appeared on the topic written by a mainstream historian. Mere articles published in journals or anthologies exist, and most of them do not even focus on the gas vans themselves but instead on some location like the Chełmno camp in Poland or the Semlin camp in Serbia, on certain German armed units, in particular the German anti-partisan *Einsatzgruppen* behind the Russian front, or events where they are said to have been used, like the euthanasia action, to name a few. We will encounter many of these papers in the present study. But before doing this, I want to discuss the one mainstream paper which comes closest to a study of the gas vans as such. By so doing we will recognize the dire need for a much more thorough and critical study.

In 1987 German historian Mathias Beer published a paper whose German title translates to “The development of the gas vans for the murder of the Jews.” In it he tries to describe, based on 14 documents and many more testimonies, how National Socialist Germany developed this murder weapon. Right at the beginning of his paper he admits that all extant documents are from a late phase of these vans’ deployment, hence could elucidate little about their development. To remedy this, he resorts to verbal claims made by various persons asserting to have witnessed something, most of whom were interrogated during some criminal investigation or trial. Knowing that by relying on such statements Beer enters shaky territory, he declares that “due to their peculiarities testimonies” need to always be linked to, that is to say supported by, some documents, and that those documents themselves need to be “subject to thorough source criticism” (all on p. 404).

I agree with this, as this is a standard method of historiography. Yet Beer has missed two important issues here: first of all, each testimony,

whether supported by a document or not, needs to be subjected to criticism as well. A medieval testimony claiming that the devil rode by on a broom stick having sex with a witch, supported by a medieval document claiming to document that very “fact,” might fulfill Beer’s criteria, but it does not constitute truth. The creator of a document can err and lie just as much as a witness. Next, Beer completely omits the most important group of evidence: physical, tangible evidence. Where is the flying broomstick? Where is the devil? Did the devil leave his semen in the witch?, etc. are all very important questions to be asked.

In our context these questions would be: Where are the vans? Where are the corpses? Where is the poison in their body?

Beer is completely mute on all accounts: no scrutiny of the witness testimony performed, no material traces requested, no questions asked about the construction and operational mode of these vehicles. And worse still: he fails his own criterion that document criticism is pivotal, because his paper does not contain any critical discussion of any of the documents he cites or at least a reference to such a discussion (which does not exist among orthodox historians, I may add).

Hence Beer’s paper is a complete failure already on formal grounds. But that is not the end. His self-defined goal to trace the development of the gas vans within the framework of documents falls flat as well. As Mattogno has shown (2011a, chapter 1), Beer’s lengthy “reconstruction” of how the gas vans allegedly came into being is not based on any documents, as Beer himself admitted. What remains are the testimonies on which Beer relies heavily. We will encounter most of them in this study, where we will subject their statements to critical scrutiny. The result is shocking: many of the important witness statements used by Beer can be demonstrated to be highly implausible (see, for instance, two of the persons allegedly responsible for the vans’ development: August Becker, chapter 3.7.3.3., and Albert Widmann, chapter 3.7.4.7).

While doing his research for his own 1994 study on the gas vans, Pierre Marais had noticed Beer’s complete lack of a critical attitude, as a result of which he wrote him a letter with several questions, to which Beer responded accordingly. I have reproduced this exchange with Marais’ comments in Appendix 10 (p. 362). Although Marais’s questions to Beer weren’t as hard-hitting as I would have formulated them, Beer’s subsequent refusal to continue the exchange shows who of the two is a dogmatic ideologue and who a critical freethinker.

Any decent researcher would have taken such critical inquiry as a reason to look into his own research again and to amend it where necessary. But such an open-minded approach does not seem to be Beer's cup of tea, for when he had a slightly abridged and updated version of his 1987 paper published in a 2011 anthology (Morsch/Perz/Ley, pp. 154-165), it exhibited the same deficiencies of superficiality. Here again, Beer's references to documents and witness accounts serve only to once more uncritically repeat what he has read. In addition, this new version of Beer's paper also lacks any reference to – and discussion of – any topical criticism made during the past two decades (mainly Marais 1994 and Weckert 2003). Hence Beer, like most mainstream Holocaust authors, has proved to be impervious to critique, which means that he is unsusceptible to the scientific method.<sup>3</sup>

In view of the total failure of orthodox historiography to appropriately address the issue of the “gas vans,” Pierre Marais 1994 monograph on the “gas vans” was a sorely needed study indeed. Unfortunately it remained without any reaction from the historiographic establishment.

The present study will start by including and summarizing what Marais has already revealed and by carrying the topic farther and deeper.

---

<sup>3</sup> Beer has added an inconspicuous deception to this paper which is common among mainstream Holocaust authors: He quoted Becker's letter to Rauff with “since December 1941, for example, 97,000 were processed with 3 deployed vehicles” (Morsch/Perz/Ley, p. 164), *i.e.* with a lower case “since,” thus giving the false impression that this statement is to be found somewhere in the middle of the letter, whereas it is actually its very (absurd) beginning. See chapter 2.2.4.1.

# 1. Material and Forensic Evidence

## 1.1. Material Traces of the Weapon of Crime

When there is sufficient reason to suspect that a murder has been committed, finding the murder weapon and at least traces of the victim are key issues during the investigation of what has happened. This is so for court proceedings in a state under the rule of law, but this ought to be also a pivotal point for any independent scientific investigation. After all, one of the most important tenets of science is that a claim must be substantiated, or else it is not much more than mere hot air. To be more precise: substantiating a person's claim requires more than coming up with more individuals making the same or a similar claim. If we merely collect claims, we may thus obtain a number, maybe even a great number of identical or similar claims, but they are still mere claims. Substantiation requires most of all substance: hard, physical, tangible evidence beyond mere statements.

In the case investigated here the allegation is made that during the Second World War a huge number of individuals was killed at various points in time and at numerous locations by means of "gas vans" deployed by German units. Some of the killings are said to have happened in the course of fighting partisans in the Soviet territories temporarily occupied by the Germans; others ostensibly happened in the context of the implementation of the so-called "Final Solution to the Jewish question," which, according to orthodox historiography, meant the physical annihilation of many Jews within the German realm of influence during World War Two.

The partisan warfare during World War Two followed its own, at times cruel, rules. In this context, summarily killing partisans was not an illegal activity, if judged by international law as in effect at that time.<sup>4</sup> Even West German courts of law dealing with partisan killings allegedly committed with "gas vans" did not sentence any defendant on

---

<sup>4</sup> On the sometimes cruel but, during World War II, generally accepted customs of warfare – when it comes to killing civilians – see Siegert 2003; on partisan warfare see Seidler 1998.



this ground alone, as killing partisans by whatever means, as long as it was not excessively cruel, was considered a legal act of war.<sup>5</sup> Communist East German trials, on the other hands, always considered the killing of partisans a crime (see chapter 3.8.1.). Since the present study is not about legal considerations but rather about the evaluation of evidence presented, the legal aspects will not be discussed any further.

Although most of the killings said to have been perpetrated with “gas vans” are claimed to have occurred within the so-called “Final Solution,” I will not enter into a discussion of this term and its historical interpretation either, as this would lead us far astray from our actual topic and because both orthodox and revisionist literature about the “Final Solution” are replete with considerations on this topic.

In these “gas vans” the Germans are said to have used the vehicles’ exhaust gases for homicides, the most toxic component of which is carbon monoxide (CO, sometimes also referred to as carbon oxide). This gas is a result of an incomplete combustion of the carbon component of fuels consisting of hydrocarbons, like gasoline and Diesel fuel. Complete combustion leads to carbon dioxide (CO<sub>2</sub>), which is much less toxic than CO. I will elaborate on this a little more in chapter 1.3. Suffice it here to say that the claimed weapon of crime in a more narrow sense is said to have been a standard truck or van engine as it was mounted into the vehicle by the manufacturer without any modification. The truck itself, however, is said to have been retrofitted with certain additional equipment permitting the actual homicide. What exactly these changes to the serial trucks and vans were is one of the central questions to be elucidated by the present study, next to determining the make and model of the trucks themselves as well as the engines used.

German documents from 1942 prove the order of thirty special cargo boxes mounted onto the chassis of Austrian Saurer trucks sporting Diesel engines.<sup>6</sup> The vehicles thusly equipped are claimed to have been used as “gas vans” especially by the so-called *Einsatzgruppen*, German armed forces officially in charge of combating partisans operating behind the German lines at the eastern front. One would therefore have to expect that one or several of these vehicles were captured by the Soviets during their counter-offensives, but this is apparently not the case. In

---

<sup>5</sup> Many defendants in West German trials claimed that they had only killed (or known about the killing of) partisans, but the judges usually did not believe them; see chapters 3.7.4.3. to 5., 3.7.4.9. & 3.7.6.11. In one case, however, the defendant’s claim was accepted, resulting in his acquittal, see chapter 3.7.5.5.

<sup>6</sup> See the “Dossier R 58/871 f° 1” in Appendix 4.

fact, no information exists about a location where one could investigate a wreck of such a gas van or even only some instructive traces of the special retrofitting which inevitably would have been required for the deployment of these vehicles for homicidal purposes. The Soviets, however, are said to have captured some of those responsible for the homicides in gas vans, whom they put on trial in 1943 (see chapters 3.2. and 3.3.). How do they explain the fact that they managed to catch some of those who had operated the trucks, but that the vehicles themselves simply vanished?

Mainstream historians, like Mathias Beer, are wont to respond to this glaring lack of any material trace of these elusive vans by coming up with a pseudo-explanation (see Beer's letter to P. Marais, p. 365):

*"It would not be surprising if no gas vans had been found after the war, because the gas vans, like all other traces left by the extermination of people, were destroyed as best as possible in the rush."*

This does, however, render Beer's position even worse, as this claim also requires supportive evidence – this time to prove that the Nazis did indeed manage to erase all those traces, and how this was possible. After all, the lack of evidence does not prove a claim to be true, which is what Beer tries to argue here. If anything, the lack of evidence refutes the claim.

As we will see, the operation of a truck suffocating humans locked inside of it is rather easy. There are no difficulties constructing it, and its production *a posteriori* would doubtlessly have been quite easy. That no such attempt was ever made makes the whole issue even more mysterious.

The claim that thirty vehicles retrofitted for mass gassings, which would have served as a vivid example of the "Nazi barbarity," have simply disappeared without trace ineluctably had to raise certain doubts about their very existence. Unless new information surfaces, one cannot but conclude that the "murder weapon" in the form of these infamous "gas vans" could not be produced to this very day. There are absolutely no tangible material items: no truck, no part of a truck, no drawing or blueprint of a truck.<sup>7</sup> As we will see during the analysis of the existing documents, not even a technical study of these ostensible gassing vehi-

---

<sup>7</sup> In the above-mentioned letter Beer claimed that a gas van wreck actually exists as a memorial in the town of Konin, Poland, near the former Chelmno camp. But an inquiry by P. Marais with that town's authorities exposed this claim as false; see Appendix 10, page 370.

cles exists, and it is incomprehensible how such a vehicle could have been constructed without a corresponding technical drawing.

## 1.2. Material Traces of the Victims

Both the Serbs and the Soviets conducted forensic investigations by exhuming mass graves allegedly containing victims of “gas van” mass gassings.

The Soviets conducted their investigations right after they had reconquered territories from the Germans in early 1943. A summary of the findings were published during the war in a booklet containing a summary of two trials staged in 1943, where the defendants had been accused, among other things, of having participated in the mass murder of Soviet citizens with “murder vans.”<sup>8</sup> I will analyze the horrific circumstances of these Soviet wartime show trials in chapters 3.2. and 3.3. Here I will address only the forensic findings of the Soviet investigating committee, which were quoted as follows in the booklet *The People’s Verdict* (1944, p. 13; similar on p. 32):

“[...] 623 [exhumed corpses] were examined by medical experts [...].

*On the basis of the thorough medical, chemical and spectroscopic investigation which was carried out, a Committee of Experts consisting of Dr. V. I. Prolorovsky [...] arrived at the conclusion that the cause of death in 523 of the cases examined was carbon monoxide poisoning. [...] In their report the Committee of Experts stated that the carbon monoxide could undoubtedly have had lethal effect if the waste gases from the Diesel engine penetrated the closed van.*

*The Commission stated:*

*‘If the outlet for the carbon monoxide (including waste gases) is in closed premises, the concentration of carbon monoxide in those premises increases very rapidly and may cause death even in the course of a few minutes (from five to ten).’*

---

<sup>8</sup> There exists another instance of a claimed Soviet forensic investigation: 214 exhumed, former mentally sick children who are said to have been killed in a gas van. This forensic expert report, also dating from 1943, was introduced as evidence for the prosecution during a West-German court of law in 1972 (see chapter 3.7.5.3.). I have so far not been able to obtain a copy or even a summary of this expert report. Maybe the exhumed children shown in Illustration 1 are from that source.

[...] *The total number of the Soviet citizens asphyxiated in ‘murder vans’ is 7,000.*”

Soviet wartime expert commissions are notorious for faking and lying about their alleged findings, as the Katyn case amply demonstrates (Sanford 2005). That there is something very fishy about this “expert report” results from the fact that finding carbon monoxide in severely decomposed corpses is impossible even with today’s refined forensic methods, which are far superior to the crude spectroscopic methods used in the 1940s. Only in 2010 a method based on gas chromatography was established which allowed reliable detection of carbon monoxide levels in severely rotten tissue and blood samples (Walch *et al.* 2010, p. 23). Hence, how would it have been possible for these Soviet experts to prove carbon monoxide poisonings in corpses which have been rotting in their graves for many months, if not more than a year, by using a



**Illustration 1:** Photograph taken by Soviet commission of corpses exhumed in 1943 from a grave near Krasnodar.<sup>9</sup> The caption reads:

*“Atrocities of German-Fascist invaders in Krasnodar. Photo shows corpses of children poisoned with carbon monoxide gas by the German invaders. The dead bodies have been extracted from a pit for medico-legal examination.”*

However, who these victims are, how and when they died, and who murdered them, if anyone, is completely unknown.

<sup>9</sup> <http://collections.yadvashem.org/photosarchive/en-us/11290.html>; similar but not quite as clear: [.../69350.html](http://collections.yadvashem.org/photosarchive/en-us/69350.html), [.../69926.html](http://collections.yadvashem.org/photosarchive/en-us/69926.html); Yad Vashem does not give an archival source for these photos.

method that is unsuitable for this to begin with? How decomposed the corpses were can be gleaned from a photo added to one of the reports, see Illustration 1.<sup>10</sup>

Another indicator that this commission most certainly was not expert at what it stated is the fact that they claimed that, due to the “Diesel engine” exhaust gases piped into the cargo box, “the concentration of carbon monoxide in those premises increases very rapidly and may cause death even in the course of a few minutes (from five to ten).” As I will show in the next chapter, this is simply not possible with Diesel exhaust gases.

In addition to the Soviets, their loyal communist allies in Yugoslavia also performed an investigation by having a War Crimes Commission exhume two mass graves after the liberation of Serbia. They presented their results in March 1945. Orthodox historian Byford writes about this (2010, p. 25):

*“In fact, the [Commission’s] approach to evidence was determined primarily by political concerns. [...] For instance, in the winter of 1944/1945, the War Crimes Commission, acting upon reliable evidence, unearthed approximately 11,000 bodies at two sites where victims of the Semlin<sup>[11]</sup> Anhaltelager were said to have been buried. And yet its report, published a year later, stated that the total number of casualties was as high as 40,000. This figure was arrived at by adding up the various unverifiable approximations offered by a relatively small number of witnesses and former inmates whose statements were collected in the course of the investigation. Similarly, in the case of Banjica, although log books discovered after the war suggested that the total number of inmates was 23,637, of whom 4,286 were executed, the War Crimes Commission dismissed both figures as too low and stated that the actual number might be as high as 80,000 dead.”*

Hence we face the problem that here, too, propaganda and political purposes irreparably corrupted the record. If the commission did indeed find 11,000 corpses – who guarantees us that this number was not already exaggerated? – but they lied about that, then how can we trust them about anything we can find in their report?

---

<sup>10</sup> This Soviet medical expert report is available in the Central Archives of the Federal Security Service (former KGB) of the Russian Federation in Moscow, file H-16708 (Krasnodar trial), vol. 1, part 1, p. 32; quoted acc. to Bourtman 2008, p. 254.

<sup>11</sup> Serbian name: Sajmište.

In early 1942, the Semlin *Anhaltelager* was called *Judenlager* (camp for Jews), as almost exclusively Jews were interned there, until they were allegedly killed with gas vans in the spring of 1942. The number of Jews killed in gas vans is supposed to have been around 7,000 to 7,500 (Byford 2010, p. 6; Manoschek 1998, p. 229f.; Browning 1983, p. 61). After all Jews had been removed from the camp by May 1942, the camp changed its function and was renamed to *Anhaltelager*. Byford writes about this phase of the camp (*ibid.*):

“[...] *Semlin became an Anhaltelager, a temporary detention camp for political prisoners, captured partisans and forced laborers, most of whom were subsequently transported to various labor camps in Germany and Norway. Between May 1942 and July 1944, 32,000 inmates (mainly Serbs) passed through the camp, of whom 10,600 died of starvation, exposure and disease or were killed.*”

Hence it seems that the 11,000 victims allegedly found by the Yugoslav investigation commission were exclusively victims of this later phase of the camp, when no Jews were held in it anymore. There does therefore not seem to be any forensic proof that even a single person had died in a gas van. If they did, where are their bodies?

Christopher Browning has the following answer to that question (1983, p. 85):

“*In December 1943, Paul Blobel’s Kommando 1005, charged with digging up and burning the bodies from the mass graves left behind by the Einsatzgruppen in Russia, arrived in Yugoslavia, and liquidated the mass graves near Avala [where, it is said, the gassed victims were buried] among others.*”

We’ve heard that before: the evil Germans saw to it that all the remnants of these 7,000+ victims disappeared tracelessly, and the traces of the former mass graves along with them. Dare I say that this would have been an impossible feat? But if I am wrong, I wonder why the Germans did not perform this same miracle again on those 11,000 victims of the later phase of the camp.

## 1.3. Forensic and Technical Considerations

### 1.3.1. The Toxicity of Diesel Exhaust Gas

During this study we will encounter over and over again the claim that the alleged mass murder with “gas vans” is said to have been conducted with the exhaust gases of Diesel engines, either expressly or implied by the vehicle make used (Saurer). It is important to know that by the mid-1930s the Diesel engine had displaced the gasoline engine almost completely on the heavy utility vehicle market in Europe.<sup>12</sup> This is particularly true for the Swiss-Austrian truck manufacturer Saurer, who equipped their trucks only with Diesel engines<sup>13</sup> – in fact, Saurer had been a Diesel engine pioneer for decades.<sup>14</sup> This is an important observation, because from wartime documents we will learn that Saurer delivered the chassis and engines for the thirty ordered gas vans which are said to have been the vast majority of vehicles allegedly used as gas vans, in particular for what Mathias Beer calls the “perfected” “second generation” of gas vans (Beer 2011, p. 159).

Whether one can commit murder with Diesel engine exhaust within the time spans claimed is a forensic question. U.S. engineer Friedrich P. Berg has done thorough research about this, which he first published in 1984 and, in his latest revised and expanded form, in 2003 (in Rudolf 2003, pp. 435-469). Berg also elaborated in detail about the toxic effects of carbon monoxide and other constituents of Diesel engine exhaust gases. I will not repeat any of this here, as it would be repetitive and would lead us too far afield. The interested reader might either consult Berg’s paper or any handbook of toxicology from any library directly.

Whereas gasoline engines operate with a dearth of oxygen and therefore produce rather high amounts of toxic carbon monoxide, Diesel engines always operate with a huge excess of oxygen, as a result of which its exhaust gases contain only minor amounts of carbon monoxide, the lethal compound in engine exhaust gases.<sup>15</sup> Although not impossible, it is rather difficult to increase the amount of carbon monoxide in Diesel exhaust gases. If a Diesel engine runs idly or with only a minor load, it

<sup>12</sup> See [www.flambino.ch/truck/uebersaurer/geschichte\\_saurer/geschichte\\_saurer.htm](http://www.flambino.ch/truck/uebersaurer/geschichte_saurer/geschichte_saurer.htm).

<sup>13</sup> [www.saureroldtimer.ch/5000geschichte/5200chronosaurer/index.html](http://www.saureroldtimer.ch/5000geschichte/5200chronosaurer/index.html).

<sup>14</sup> See [http://de.wikipedia.org/wiki/Adolph\\_Saurer\\_AG](http://de.wikipedia.org/wiki/Adolph_Saurer_AG);  
[http://en.wikipedia.org/wiki/Diesel\\_engine](http://en.wikipedia.org/wiki/Diesel_engine); cf. Wipf/König/Knoepfli 2003.

<sup>15</sup> It must be kept in mind that the CO contained in the exhaust gases is an incompletely combusted item resulting from a lack of oxygen.



must even be considered impossible to produce an exhaust gas whose composition can become acutely dangerous to persons with an average health within the time span of interest here (up to half an hour).

In contrast to this stands the drastically larger carbon monoxide content in the exhaust gases of gasoline engines, which can be manipulated in various ways to increase it even more, for instance by closing the idle-mixture adjustment screw of the carburetor. For this reason gasoline engines would have been the self-evident choice for the construction of “gas vans” (as also for the generation of carbon monoxide for the stationary “gas chambers”).

Did the Germans know about the difference between Diesel and gasoline engine exhaust? Both engines had been invented in Germany,<sup>16</sup> and the record shows that German engineers and scientists were very well aware of that difference long before World War Two. Once again it was Berg who has documented the use of Diesel engines early on in coal mines in Germany exactly because their exhaust gases were relatively harmless (in Rudolf 2003, pp. 452ff). Mattogno and Graf have shown in turn that German scientists had made thorough exhaust gas composition analysis of a broad variety of gasoline engines, which was for instance published in a 1930 book dedicated to the toxicology of gasoline engine exhaust gases (Mattogno/Graf 2005, pp. 123-125; cf. Keeser/Froboese/Turnau 1930).

In 1994 Berg drew attention to a forensic study conducted by British scientists who had conducted a test gassing of rabbits, mice, and guinea pigs with Diesel engine exhaust gases. They “succeeded” in killing all their animals only after going to the engine’s limit and after more than three hours of exposure (Pattle *et al.* 1957). In this context it deserves emphasis that Diesel exhaust gases have other features than delivering small amounts of carbon monoxide which need to be considered. In particular old engines produced a lot of smoke (particulate matter; see Berg, in Rudolf 2003, pp. 451f.), which consisted not only of soot but also of a mixture of highly irritating, smelly chemicals. And like all exhaust gases, Diesel exhaust gases are hot when exiting the tail pipe:

---

<sup>16</sup> The four-stroke gasoline engine was first patented by the German watchmaker Christian Reithmann on 26 October 1860 ([http://de.wikipedia.org/wiki/Christian\\_Reithmann](http://de.wikipedia.org/wiki/Christian_Reithmann)); today these engines are frequently called Otto engines due to the first car engine built by Nikolaus Otto of the Deutz engine factory in Cologne, employing as technical directors for engine construction Gottlieb Daimler (later of Daimler-Benz) and Wilhelm Maybach; the Diesel engine was patented in 1893 by German engineer Rudolf Diesel ([http://en.wikipedia.org/wiki/Diesel\\_engine](http://en.wikipedia.org/wiki/Diesel_engine))

well beyond 100°C (200°F). Although the toxic effect of Diesel exhaust gas is moderate at worst, the combined effect of irritating chemicals, smoke, heat, noxious gases and oxygen deprivation will kill most people locked up in an enclosed space filled with such gases after an extended period of time. But as the above experiment shows, it would take hours of horrific suffering.

This proves that attempts at mass gassings with Diesel engines would have been a disaster at best.

Friedrich Paul Berg has not only pointed out that the use of Diesel engine exhaust gases for mass murder would have been absurd, but that the use of *any* exhaust gas is absurd when considering that the Germans, suffering from lack of petroleum during WWII, had retrofitted almost their entire truck fleet during the war with so-called producer gas generators. I will elaborate on this more in chapter 2.4. when discussing wartime documents, as the extant documentation about this technology stems primarily from that era.

Surprisingly, this finding of the general unsuitability of Diesel engines for a swift and efficient mass murder was recently confirmed by an orthodox anthology on the Holocaust, where the toxicologist Achim Trunk writes in a paper entitled “The lethal gases” (Morsch/Perz/Ley 2011, pp. 35f.):

*“It can be derived from the animal experiments that it is possible in principle to murder human beings with Diesel exhaust gases – even many simultaneously. In order to generate highly toxic exhaust gases which kill within a maximum of 20 minutes, however, Diesel engines in the facilities for gas murder would have had to be operated under heavy load, i.e., they had to be slowed down. Such a slowing, power-consuming device (such as a dynamometer) was much less simple and cheap to obtain than the large engine from a destroyed vehicle wreck. Slowing down a powerful Diesel inside a gas murder facility would have meant moreover that the engine would have become much noisier and would have vibrated much more intensively. Its exhaust gases would have contained a lot of soot. Whether such features have been observed (or whether clues to power consuming devices exist) is no longer a question to toxicology but rather to the sources and source criticism. According to this author’s knowledge, no clues in that direction exist.*

*A different explanation is more likely, according to which the murder weapons were all gasoline engines. [...] That gasoline en-*

*gines were indeed deployed in the extermination camps of the 'Aktion Reinhardt' derives from reliable sources. Rudolf Reder, for instance, one of the very few survivors of the Belzec extermination camp, spoke of an engine fueled with gasoline located in a small room next to the gas chamber. It is said to have consumed 80 to 100 liters of gasoline daily. For the later-day extermination camp Sobibór, where one could apply the experiences gained in Belzec, exact statements by the perpetrators exist that the murder device was a gasoline engine; [...] In the case of Treblinka, which was the latest of the extermination camps of the 'Aktion Reinhardt' to be built (and the biggest), science has so far assumed that a Diesel engine was used. This raises the question why, from the point of view of the murdering institution, a successful method should have been replaced by a different, technically much more difficult."*

It is worth noting in this context that Reder, in his testimony about Belzec, expressly and in various ways stated that the engine's exhaust gases were *not* used for murdering the victims. The other star witness of orthodox historiography for the alleged exhaust gas mass murders in Belzec, the mining engineer Kurt Gerstein, speaks repeatedly of a Diesel engine providing the poisonous gas.<sup>17</sup> He, as a mining engineer, certainly knew to tell a Diesel from a gasoline engine. However, contrary to what Trunk wants us to believe, neither Reder nor Gerstein are reliable witnesses, as both their testimonies are riddled with absurdities and impossibilities (for details see Mattogno 2004a). I may mention in passing that it is not at all trivial to run a stationary gasoline engine, as they – in contrast to Diesel engines – tend to overheat quickly. They require special cooling devices to be kept operational.

Trunk's last sentence quoted above about the anachronistic reversal to an imperfect method is of course valid. It also applies to the gas van issue. Here the first generation of gas vans consisting of a mixture of makes, models and equipments with usually undefined engine types, some of which may have been gasoline engines, are said to have been replaced with a more sophisticated "second generation" of vans driven by – Diesel engines. This fact is glossed over by Trunk who erroneously or deceptively writes (Morsch/Perz/Ley 2011, p. 37):

*"Reports about the killings with gas vans explicitly give gasoline engines as the source of the lethal gas."*

---

<sup>17</sup> On this see the doctoral dissertation by Roques 1985, two volumes, plus: Roques 1986, Chelain 1989.

Trunk is definitely disingenuous when he writes (*ibid.*, p. 37):

*“The claim by revisionists is wrong that it is impossible in principle to commit mass murder with Diesel engines.”*

Trunk, who quotes Fritz Berg’s 1984 paper on Diesel gas chambers (his footnote 27, p. 33), hence knows about Berg’s work, has used many of the sources and arguments from Berg’s various papers, yet he has failed to acknowledge that Berg’s claim is *not* that mass murder with Diesel exhaust engines is impossible, but rather that it is extremely cumbersome and absurd, especially when considering the available alternatives – just as Trunk has concluded.

### 1.3.2. Hermetically Sealed Gassing Boxes

When studying pertinent documents and witness testimonies about “gas vans” in subsequent chapters, we will frequently encounter the claim that the gassing box used to kill the victims was hermetically sealed, hence that the exhaust gases piped into it had no way of escaping but were accumulating inside the box. I will deliberate about this already now, while discussing forensic and technical matters.

The questions raised by this claim are as follows:

1. How quickly does the gas pressure rise inside the alleged hermetically sealed gassing box?
2. What is the effect of this steady rise in internal pressure on the gassing box and on the engine?

Question two has basically two possible answers:

2.a) Either the gassing box bursts, as it can no longer withstand the internal pressure, or

2.b) the engine stalls, as it can no longer expel its exhaust gases into the pressurized gassing box.

Which of the two events happens depends on the stability of the gassing box and on the capability of the engine to overcome an external pressure, which is called exhaust gas back pressure. We will investigate both next.

With the advent of turbochargers and catalytic converters, exhaust gas back pressure has become an important feature of combustion engines. There exists therefore a plethora of data about it, although none of it reaches back pressures anywhere close to where an engine would stall. Under normal operational conditions, engines running on high rpms can produce a back pressure of up to one atmosphere in extreme

cases with no sign of stalling.<sup>18</sup> The exhaust back pressure required to stall an engine would therefore be considerably higher, yet of course also noticeably below the engine's compression rate. The actual value depends primarily on the engine's compression rate, which was somewhat lower for engines during the 1940s than it is today, although Diesel engines have always used higher compression rates than gasoline engines, as they have to compress the fuel/air mixture to the point where it self-ignites. They will therefore stall later than gasoline engines.

If the exhaust pipe of a running engine is connected to a hermetically sealed container, the gas pressure in the latter will rise to the point where either the engine stalls or the container fractures or bursts due to its internal pressure. If the container resists the steadily increasing pressure, the engine will stall as soon as the engine's threshold value for tolerable exhaust gas back pressure has been reached.

For the sake of the argument we may assume that a wartime Diesel engine could still be operated at an exhaust back pressure of two atmospheres (ca. 2 bar). We will now calculate the amount of gas produced by such an engine.

For lack of better data, let us assume a moderate truck engine volume of five liters<sup>19</sup> and an engine speed of only marginally above idle – say 1,000 revolutions per minute. A four-stroke engine discharges its exhaust gases only after every second revolution, so we would have 500 times five liters of exhaust gases produced in a minute, which equals 2.5 m<sup>3</sup> of exhaust gas. Although it is true that the exhaust gas is slightly pressurized when exiting the cylinder, it cools down considerably afterwards and hence contracts. Within the error margins of our rough calculations, both effects can be considered to compensate each other, so we will ignore them here.

The cuboid cargo boxes claimed to have been used are said to have had a free volume of some 15 to 20 m<sup>3</sup>.<sup>20</sup> This means that the pressure

---

<sup>18</sup> [http://www.aalcar.com/library/exhaust\\_backpressure.htm](http://www.aalcar.com/library/exhaust_backpressure.htm).

<sup>19</sup> One of the vans found after the war which was initially speculated to have been used as a gas van had a 7.4 liter Diesel engine; see <http://dss.ucsd.edu/~lزامosc/chelm00.htm>. But for the sake of the argument I reduce it to a smaller size.

<sup>20</sup> The cargo boxes manufactured for Saurer trucks were 5.8 m long, 1.7 m high (see the document on p. 306) and probably some 2.3 m wide (the documents do not mention a width, but the width of trucks varies usually between 2.30 and 2.50 m. A standard container today has a width of 2.44 m). This amounts to some 22.7 m<sup>3</sup>, of which the body volume of the victims has to be deducted. Some 50 to 130 victims are claimed (see chapter 4.2.4.), which, with an average weight of 60 kg  $\approx$  (60 liters) amounts to ca. 3 to 8 m<sup>3</sup> of filled space. Hence I subsequently calculate with some 15 to 20 m<sup>3</sup>.

in such a cargo box, if closed hermetically, would have doubled within some six to eight minutes. Although such an overpressure is unlikely to make the engine stall, as Diesel engines run on high compression rates, the pressure exerted on the walls of the cargo box would have been immense: 1 atmosphere ( $\approx$  1 bar) of overpressure equals by definition the effect of a weight of one kilogram per square centimeter, or ten metric tons per square meter. Since the long wall of the cuboid cargo box under scrutiny was 5.8 meters long and 1.7 meters high,<sup>21</sup> hence had a surface area of almost 10 square meters, 1 atmosphere of overpressure would have been equal to a load of 100 metric tons! There is no way such a cargo box could have withstood such a force. Already with a tenth of that load – and at a tenth of the time (less than a minute) – the cargo box would have been bound to burst or even explode, had it really been sealed hermetically.

For this reason truck containers designed to withstand any kind of pressure have cylindrical shapes with convex or semi-spherical bases, as can be gleaned from tank cars and generally with containers holding liquids or gases under pressure, for the circular shape distributes the forces exerted by the pressure equally over the entire structure.

It is therefore impossible that any gas van which is said to have piped engine exhaust gases into its cargo box was equipped with a hermetically sealed cargo box. The box had to have some excess pressure release valve or opening in its coachwork somewhere.

This will become a most important point when discussion the so-called Just document (chapter 2.2.4.), which insists on the alleged fact that the gassing box needed to be hermetically sealed in order to function, but at once states that “97,000” persons “were processed” “without any defects in the vehicles becoming apparent.” This is technically impossible, plain and simple.

---

<sup>21</sup> This is valid for the Saurer trucks. The dimensions of the cargo boxes of the other claimed truck models from Diamond/Renault/Opel/Mercedes/... are unknown, but as they are frequently referred to as the “small vans,” they must have been considerably smaller. This does, of course, not have any effect on the pressure exerted per square meter of surface area.

## 2. Documents

### 2.1. Photographs

If, due to lack of reliable information, one assumes that not a single gas van and no characteristic part of it survived the war, then the next question to ask is whether photographs of the time span exist during which these vehicles were allegedly used. And in fact, several photos of vehicles do indeed exist about which it is claimed that they served as “gas vans.”

The best known of these photographs was reproduced by Gerald Fleming (1984, after p. 92) with the caption:

*“Gas van used to liquidate Jews at the Kulmhof (Chelmno) extermination camp and near Konitz.”*

Christopher Browning reproduced this and a similar photo of the same vehicle with a similar caption (1985):

*“Gas Vans (2 pictures), taken by Polish photographer after the liberation –Yad Vashem Archives.”*

The originals of these photos (four of them all in all) were taken by the Commission of Inquiry into the German crimes in Poland at war’s end and are now in the Commission’s archives in Warsaw (signatures 47396 to 47399). Copies of the originals of these photos are, *i.a.*, located in the archives of the Auschwitz State Museum and of the Yad Vashem Institute in Jerusalem, from where one can easily procure a copy.<sup>22</sup> In 1988 Yad Vashem has stated in a letter to a revisionist researcher that back then the photos published by Fleming and Browning were the only ones it had showing a gas van, and it asked to send in further such photos, should the occasion arise, from which one may deduce that at that time Yad Vashem didn’t have any other photos either (see Appendix 10). The photos are reproduced in Appendix 1 (starting on page 275). What do we see there?

The first photo (Illustration 12) shows a truck which has been photographed from the front slightly to the left so that one can see its left

---

<sup>22</sup> Search online at <http://collections.yadvashem.org/photosarchive/en-us/search.html>.



side. Three men are looking at the truck. The photo in Illustration 13 shows that the truck had a cargo box closed at the rear by a two-winged door, the left wing of which is standing wide open in the first photo. The cargo box extends into the room over the driver's cabin as is common for moving trucks. The radiator grill sports the logo of a German producer: Magirus.<sup>23</sup> As can be seen from the second image, the wheels of the truck seem to be missing, and the number plate is invisible. A photo taken from the rear shows that the cargo box was made of many vertical wooden boards (Illustration 15, p. 277). A photo taken from the interior of the truck's cargo box, though blurred, does not show the wooden boards, hence has obviously been lined with same sheeting. The picture also shows some probably wooden framework of unknown purpose (see Illustration 16, p. 277). As we shall see later, such a framework is never mentioned by any witness.

Although both Gerald Fleming and Christopher Browning have claimed that this is a homicidal "gas van", an impartial observer can easily recognize that *nothing* visible about this vehicle supports this claim. But then why do orthodox historians like Browning and Fleming present it as a depiction of a gas van for homicide? Have they investigated and verified their sources before they added their caption to this photo of an absolutely mundane, apparently decommissioned vehicle – perhaps one among many thousand others that could be found?

Another detail catches the attentive reader's eye: All witnesses quoted in the literature as well as in the various court protocols claim that the "gas vans" exclusively belonged to the five makes Saurer, Diamond, Opel, Renault, and Daimler Benz (see chapter 4.2.2.);<sup>24</sup> Magirus is not mentioned a single time.<sup>25</sup> The two important documents which we will discuss later in detail likewise mention merely "gas vans" made by Saurer and Diamond.

---

<sup>23</sup> The Klöckner-Humboldt-Deutz AG in Ulm, Germany, which had been formed in 1936 as a merger of the truck manufacturer Magirus and the engine manufacturer Humboldt-Deutz plus in 1938 with the steel producer Klöckner-Werke AG, used this logo only until the end of 1939 for its trucks, so that the truck in the photo must be older than this. Starting in 1940 a circle with the words "Klöckner-Deutz" was used as a logo; see <http://de.wikipedia.org/wiki/Magirus-Deutz>.

<sup>24</sup> With one extraordinary exception: A West-German court verdict claimed in 1974 that a Ford truck built in the USSR was converted to a gas van in a makeshift way as late as summer 1944, see chapter 3.7.5.5.

<sup>25</sup> There are two Polish witnesses who falsely identified the truck shown in the photograph discussed here as a gas van: B. Falborski (chapter 3.6.2.3.) and S. Srebrnik (chapter 3.6.3.1.).

The origin of Fleming's photo was publicly revealed only in 1995, when Jerzy Halbersztadt, at that time director of the Polish Program of the United States Holocaust Memorial Museum in Washington, DC, posted the following text to the newsgroup Holocaust:<sup>26</sup>

*"The commission received the information that in the town KO-LO (ca. 12 km from Chelmno) in the former factory of Ostrowski there was a van which, according to the witnesses, was used in the death center at Chelmno. The van was found, photographed and researched.*

*The photos taken then are available in the Main Commission's Archives in Warsaw (signatures 47398, 47396, 47397, 47399; the best one is 47398). The captions of these photographs are till today: 'a car for killing people by the exhaust fumes at Chelmno'. One of these photos was reproduced in the Fleming's book 'Hitler and the Final Solution' with the information that it is a photograph of a 'gaswagon' used in Chelmno.*

*Despite of their captions, the photographs do not show the gas van used in the Chelmno death camp. It is clear from the testimonies of Polish witnesses kept in the same archives of the Main Commission (collection 'Ob', file 271 and others). Witnesses to whom the van photographed in Kolo was shown did not confirm that it was one of those used in Chelmno for killing people. Some of them only said that it was similar to those described in their testimonies, but not the same. The most common answer was: 'I didn't see this one'.*

*The inspection of the van in Ostrowski factory, done on 13 November 1945 by the judge J. Bronowski, did not confirm the existence of any elements of system of gassing of the van's closed platform. The witnesses called this van 'a pantehnicon van' (a van to transport furniture). It was produced by 'Magirus-Werke' with a Diesel type engine of 'Deutz'. The plate on the engine stated: 'Humboldt-Deutz A.G. 'Magirus-Werke' Ulm (Donau) Baujahr 1939 Lieferdat 739 Abn-Stempel. Fahrgestell Nr. 9282/38 Nutzlast kg 2700 Fah[r]gestell-Baumuster 023. Ei[ge]ngewicht 4980 kg. Motor Baumuster FoM 513 zul. Gesamtgew. 7900 Leistung P.S. 105 cm<sup>3</sup> 7412. Zulaessige Achsendruecke vorn kg 2400 hinten 5500.' The*

<sup>26</sup> <http://dss.ucsd.edu/~lzamosc/chelm00.htm>; response to an inquiry by Leon Zamosc, University of California, San Diego, 11 Oct. 1995; Subject: Gas vans in Chelmno; enhanced with illustrations at [www.deathcamps.org/gas\\_chambers/gas\\_chambers\\_vans.html](http://www.deathcamps.org/gas_chambers/gas_chambers_vans.html); since 1996 Halbersztadt has been Director of the Museum of the History of Polish Jews.

*thickness of the car's wooden body was 7 cm, of the door – 8 cm. The walls, door, ceiling and floor were covered from the inside with the 2 mm sheet iron. The car was painted in grey-lead color. Under this paint the inscription was seen on the door of the cab: 'Otto Koehn Spedition'<sup>[27]</sup> Ruf 516 Zeulen.....da i.TH'.*

*I cite all these details to make possible the further comments to the story of this van. It is my feeling that there are some unclear points in this story. Nobody explained for what purpose this van was used? Its door was tightened with an impregnated canvas. What for? Some witnesses had seen this car in the area of the forest of Chełmno starting from the spring of 1942. It is possible that it belonged to the SS-Sonderkommando Kulmhof, too. I came across a version that this van was used for a disinfection of victims' clothes but there are no grounds for it.*

*In 1945 the prosecutors came to the conclusion that this van was not a gas van of Chełmno. The van was left incomplete and not serviceable in Ostrowski's factory at least till 1950. The last known documents (a correspondence between the Association of Combatants 'ZBoWiD' in Kolo and the Main Commission) of April 1950 inform that there was an idea to move this van to the museum in Auschwitz or Majdanek (till 1990 there was no museum in the Chełmno forest; first monument was erected there in 1964). Those plans were not accomplished and the van was scrapped, probably.*

*Thus, there is no reliable graphic illustration of the gas vans used in Chełmno."*

This statement speaks for itself. I will address the topic of clothes disinfection or disinfestation in chapter 2.3.

Today the Chełmno Museum shows one of the photos discussed above in its exhibition with a truthful caption reading: "Vehicle found after the war at Koło on the grounds of the Ostrowski factory." The connection to the gas vans is not made explicitly, but the mere fact that it is exhibited will inevitably lead the visitor to think that this must have been such a vehicle. This disingenuous trick is typical for museums of that kind.

Since the advent of the Internet, "photoshopped" images of alleged gas vans can be found on many websites. The website [www.death-camps.org](http://www.death-camps.org) has created(!) several such images, which, together with their

---

<sup>27</sup> *Möbelspedition* is the German term for a moving company.

own comments, they use to adorn a reprint of Halbersztadt's above-mentioned text.<sup>28</sup> One image of the moving truck taken by the Polish commission has clearly been mislabeled as "Gas Van, found in the former Ostrowski Factory in Kolo." While captions printed on the larger "created" images state that they are merely "based" on a photo or have even been "created." Although a note at the bottom of the page clearly states "The pictures of the Diamond, Opel, Saurer, and gas trailer are not original. They just show their possible appearance," other websites simply copy these images without explaining that they are artwork rather than photos.<sup>29</sup> I have reproduced some of these "artworks" in Appendix 1.

Another picture of an alleged gas van appeared in several issues of the German news magazine *Der Spiegel* (1963, 1966, 1967a) as an illustration of articles dealing with trials of defendants accused of having participated in the claimed mass murders with these vehicles. This picture is reproduced in Appendix 1 as well. It shows the rear of a vehicle bearing a large cross – no doubt a red cross of an ambulance – which looks huge when compared to the person standing next to it. There is again absolutely nothing about this photograph lacking any details that would justify the captions given: "Mobile gas chamber" (1963), "SS gas van: 'The people didn't scream'" (1966), "NS gas van, 'nine to ten per m<sup>2</sup>'" (1967a). Later on, when discussing contemporary documents, we will recognize the significance of the words "nine to ten per m<sup>2</sup>." *Der Spiegel* did not give any information about the provenance of the photo. In lack of authentic photos, it was probably taken from some innocuous source, which was left unnamed so the curious reader could not recognize this deception. The first paragraph of the article belonging to the last illustration reads as follows:

*"The two box vans cruised around the courtyard of the Berlin Reichskriminalpolizeiamt (RKPA) with smoking exhaust pipes.<sup>[30]</sup>*

The reader is flummoxed: How can exhaust pipes at once smoke *and* leave the air pure? But better still: considering the relatively small size of city blocks in Berlin: Who would be so crazy and let a van cruise round and round in such a restricted area just to produce some exhaust

<sup>28</sup> [www.deathcamps.org/gas\\_chambers/gas\\_chambers\\_vans.html](http://www.deathcamps.org/gas_chambers/gas_chambers_vans.html).

<sup>29</sup> For instance <http://strangevehicles.greyfalcon.us/NAZI%20GAS%20VANS.htm>.

<sup>30</sup> Reich Police Department for Criminal Investigations.

gas, when Berlin was rich in lethal city gas coming straight from the mains, to name just one source of poison gas readily available?

I finally want to draw the reader's attention to a photo composition presented by Alain Decaux on 24 March 1983 in a documentary of the French TV channel *Antenne 2* dedicated to Kurt Gerstein, which was first exposed by Pierre Marais as a crude forgery. In it one can see parts of two vehicles, one a small section of the rear end of what appears to be a simple truck and the other the rear half of a car, from which hoses emanate running into a wall in the background. The composition apparently wants to insinuate a combined procedure – a vehicle engine blows carbon monoxide into a stationary room, in which victims are locked up – but the picture does not allow discerning anything about any special equipment of a gas van. This photo composition is a fraud used as early as 1961 in order to boost the credibility of the Gerstein “confessions.” I have reproduced it in Appendix 1 as well.

All things considered, there does not exist any pictorial evidence for the existence of “gas vans.” If photos existed, their owners would most certainly have published them by now. But since this is not the case, the only possible conclusion is that the “murder weapon” can just as little be seen on photographs as in reality, although there is a spate of reports presenting the gas vans as a proven historical reality beyond any doubt.

## 2.2. German Contemporary Documents

### 2.2.1. Introduction

If the gas vans existed indeed, then we need to find out the conditions under which they were constructed and used. In view of the thoroughness and the Germans' talent to organize, some documentary traces must have been left behind, unless one accepts the improbable thesis, which is nonetheless systematically invoked by certain historians, according to which this operation had been carefully camouflaged and that all traces have been erased.

Although it is relatively easy to construct a vehicle which asphyxiates its passengers during transit, its manufacture requires certain tasks to be done in a workshop, which are unimaginable to have been performed spontaneously. The decision to build such vehicles inexorably had to come from the top of the hierarchy, and it then had to be

handed down from one level to the next lower one down to those responsible for carrying out the necessary experiments and to those charged with deploying the vehicles.

Although I have of course no experiences in this regard – and for good reasons – it seems to me that the construction of vehicles meant to kill persons locked up inside of them during transit had to include under any circumstances three technical adaptations:

- a) Since panic among a large number of persons can drive people to extremes, such a cargo box would have to be especially strong. Hence, a robust cargo box structure had to be bolted to the chassis, fitted inside with a cage resembling a zoo's big cat cage, which could withstand both shocks during the ride as well as escape attempts of those lock up inside. This is especially true for the door, which had to be particularly reinforced in order to keep the panicking victims securely locked up inside, even if they all stormed the door. In this context I may remind the reader that a panicking crowd collectively pressing against doors, fences or even walls can make them collapse. A standard rear door of a normal van would not have done the trick. Needless to say that no such construction can be found in the documents we are about to examine.
- b) If exhaust gases were used to suffocate the victims, an engine type had to be used whose exhaust gases produced sufficient carbon monoxide to kill within a few minutes. This is to say: the truck had to be equipped with a gasoline engine. Alternatively and more convincingly, a vehicle equipped with a wood gas generator could have been used with a means to alternatively switch the wood gas to flow either to the engine or into the cargo box, although this would have rendered the van immobile during gassing operations.
- c) If exhaust gases were used, and if occasionally the truck's cargo box was also to serve as a normal transport device, then a mechanism is expected to have been added permitting to alternatively pipe the exhaust gases either to the outside as usual or through a hole into the cargo box. A flexible metal hose or a telescopic pipe extension which can be reversibly attached to the exhaust pipe comes to mind.
- d) The entry hole inside the cargo box emitting the noxious gases needed to be designed in such a way that the passengers, any accidentally falling objects or any fluid would be unable to destroy or block/plug it.

- e) Furthermore there needed to be at least one pressure relief valve or opening for the excess gases to escape. The latter point is very important and in my view is a *conditio sine qua non* for the functioning of the gas van.

If thirty such vehicles have existed, as is claimed, this means that these design changes would have been made to thirty vehicles. Under these circumstances we would have to expect at least a part of the pertinent documents in the archives, namely: correspondence on the highest level about the feasibility of the operation, a decision to allocate the required financial resources, correspondence with companies in order to obtain technical advice, cost estimates including construction blueprints, orders, invoices, etc.

In order to get an idea about the quantity of documents which would have been required for the construction of vehicles, it suffices to imagine that for instance the locksmith shop at Auschwitz received detailed written instructions even for the most minute maintenance work.<sup>31</sup>

Let us now look into the actual situation about documentary proof for the construction of the gas vans.

The first document we will thoroughly analyze, and which I consider to be suspicious for reasons explained later, forms the core of the dossier 501-PS of volume 26 of the document collection compiled by the International Military Tribunal at Nuremberg (IMT, vol. 26, pp. 103-110). It is a letter dated 16 May 1942, which I will subsequently refer to as the “Becker document.” After this I will also address three telegrams of 9, 15, and 22 June 1942 which are part of this dossier and which refer to “S-Vehicles” and the need for “exhaust hoses.”

There are indisputably authentic documents on special vehicles used by the *Reichssicherheitshauptamt* (RSHA), which, however, do not give the slightest reason to assume that they were used for homicidal purposes. One can consult these documents in the German Federal Archives (*Bundesarchiv*) in Koblenz, where they are kept in a dossier with the reference R 58/871 f° 1. They are reproduced in Appendix 4 of this book and followed by a translation and my own comments, where due. Among these documents is a note which I will scrutinize next and which I consider to be suspicious for reasons to be explained later. It is dated 5 June 1942 and bears the rubber stamp imprint “*Geheime Reichs-sache*” (secret state matter) like many military documents of that era.

<sup>31</sup> Cf. *Le Monde juif* No. 107, July/September 1982, pp. 109f. Carlo Mattogno has given many examples for this in his various books, e.g. 2010.

Due to its signatory SS-*Obersturmführer* Willy Just, it is usually referred to as the “Just document.”

The documents contained in this dossier of the *Bundesarchiv* are evidently an indiscriminate mixture of unrelated items, which creates the impression that they have been picked arbitrarily from various sources for demonstration purposes. In order to assess their respective import, it would be necessary to know where each one of them originated, so that they could be put into the context within which they emerged.

Next there is a letter allegedly written on 11 April 1942 by SS-*Gruppenführer* Dr. jur. Harald Turner, who was the head of the wartime military administration in Serbia. Although it only contains the word “delousing van,” this word is considered to be a euphemism or “camouflage word” for “gas vans” by orthodox historians, which is why I will address this highly suspicious document as well.

Then I will address an “Activity Report” by *Einsatzgruppe* B of 1 March 1942, which is so far the only known document of the *Einsatzgruppen* mentioning gas vans in their motor pool.

Finally I will briefly deal with of a letter by Dr. Erhard Wetzel from 25 October 1941, Nuremberg document NO-365, which is occasionally mentioned in the context of “gas vans,” although it does not contain this or any related term.

We ought to have expected to encounter a great number of documents dealing with the design, construction, and deployment of the gas vans, but to my knowledge the items mentioned above are the only ones hinting at the existence of such vehicles – the first group in a poorly disguised, the second in an absolutely open fashion, and the others only in the mind of the believer. In the following I will subject all these documents to a thorough analysis. This will expose the bizarre character of some of these documents as well as a number of improbabilities which should not evade the attention of an alert reader. In my opinion these documents do not only fail to prove the reality of the “gas vans,” but quite to the contrary they are a grave argument against the thesis that German units had “gas vans” for homicidal purposes.

The result of these preliminary observations is that no material traces, no photographs and no documents exist which unequivocally prove the historical reality of gas vans for homicidal purposes.



## 2.2.2. The Becker Document (501-PS), 16 May 1942

### 2.2.2.1. Origin

This letter is the most important part of the Nuremberg document 501-PS and is frequently quoted (IMT vol. 26, pp. 102-105). The other parts of that document are three telegrams, which I will analyze in chapter 2.2.3.

Paul Rassinier may have been the first to critically comment on this document (1950, pp. 175-178). Next followed German revisionist Ingrid Weckert in 1985 (pp. 18f.), with an updated and more thorough version nine years later (in 1994, pp. 193-218), which appeared in a slightly revised English translation several years later (in Rudolf 2003, pp. 215-241). In this she writes regarding this document's origin (pp. 224f.):

*“The author has in her possession two letters from the National Archives in Washington DC, USA, each of which attests to a different origin of the Nuremberg Prosecution Document 501-PS.*

*An April 26, 1945, memo from the Headquarters of the 12th US Army states that a unit of the 12th Army had found the documents in the ‘RSHA reserve depot in Bad Sulza’. The originals, the memo states, were sent to the document center in Paris.*

*The docket, which usually accompanied the documents that were presented to the Nuremberg Tribunal, is dated September 7, 1945. This paper states that the place where the document was found, as well as its source, is unknown and that it had been received from the OCC London (the British Prosecution).*

*A document without such identification, i.e., with the note ‘source and origin unknown’, lacks even slightest evidentiary value. If the defense had submitted an equally dubious paper, the Court would have rejected it instantly.”*

### 2.2.2.2. Analysis of the Form

Mrs. Weckert has subjected the document to a detailed formal critique (in Rudolf 2003, pp. 226f.), after which she concluded:

*“By now the author has in her possession three different ‘copies’ of the letter from Becker to Rauff, but a copy of the original letter is still not to be had. Evidently no such ‘original copy’ exists.”*

Her conclusions are based on the assumption that the one version which really could be addressed as an original letter is only a carbon

copy of the original, which, so she posits, should have remained with the sender rather than ended up in Berlin. This assumption is based on her hypothesis that the letter was written on very thin paper. Whether or not this letter was written on thin carbon copy paper remains to be demonstrated, as Mrs. Weckert had access only to copies of the original. But even if so, this doesn't prove that the original letter wasn't typed on such paper.

In fact, the file 501-PS as archived in the U.S. National Archives contains two versions of this letter.

One, which I call version A, is a three-page white-on-black photostat of the alleged original. Since the photographic photostat process used in those years to make copies of documents inverted black and white, the original used to prepare this document must have been a normal black on white document.

The other, version B, is a two page black on white copy full of typos, some of which reveal the Anglo-Saxon background of the typist. Instead of the signature the letter ends with a note "(Sgd)," *i.e.* the English abbreviation for "signed." Hence it is clear that this version was typed by an Anglo-Saxon. Since it contains proper SS runes, it was obviously written on a German official wartime typewriter. This version also bears all the handwritten marks and words as version A, which are very similar both in position and in style to those on version A – except for Becker's signature. All this is perfectly explicable, if one assumes that this document is a retyped copy of version A, which the typist tried to make appear as similar to version A as possible.

The file 501-PS of the U.S. National Archives contains another document signed by Fred Niebergall, Chief of Document Control Branch of the Office of Chief of Counsel for War Crimes, Evidence Division,<sup>32</sup> prepared on 19 July 1948, in which he certifies that the "attached photostat is a true and correct copy of the original." Since photostats are negative photographic reproductions of documents, this can only refer to version A.

It seems that the black on white (positive) version from which this photostat must have been taken is not part of the 501-PS file stored in the U.S. National Archives, although the Archive itself at one point had a black on white version of the first page of this document exhibited in a showcase, which has been photographed, see version C. This version

---

<sup>32</sup> This office handled the safekeeping and registration of all documents brought to Nuremberg for evidentiary purposes and assembled them into document series.

shows creased paper and a reinforcement around the filing holes, which means that this is not a mere positive reproduction of version A. Since its handwritten marks are identical with those on version A, it may be assumed that this may be the original of page one.

Carlos Porter opines “that the white document [version B] is a first draft for the black one [version A],” that is to say: version B was a draft, which some more sophisticated document “producers” used as a template to manufacture the “original” [version C], from which version A was reproduced as a photostat.<sup>33</sup> There is no way right now to prove this hypothesis.

It is a mystery why version B made it into the U.S. National Archive in the first place, since it has no probative value, never received any official endorsement, and was never used by any court of law to prove anything.

So where is the positive original now, if the National Archives insist they don’t have it? Porter tried to chase it down and came to this result (*ibid.*):

*“The National Archives in Washington [...] claim that the original documents are in The Hague. The Hague claims the original documents are in the National Archives.*

*The Stadtarchiv Nürnberg and the Bundesarchiv Koblenz also have no original documents, and both say the original documents are in Washington.”*

There is another version of the Becker document, version D, which is a photostat made from a document which must have been almost identical to version A. It was presented to Walther Rauff, who confirmed its authenticity by writing a note on the left margin saying “I received this letter in May 1942. 18 October 1945 Rauff” (Nuremberg document 2348-PS). I say almost identical, because the photostat presented to Rauff doesn’t have the handwritten paragraph marks as can be found on versions A and C, which therefore must have been added onto the “original” after the Rauff photostat copy (version D) had been made, but before the preparation of the photostat found in the U.S. National Archives (version A). The earlier version D presented to Rauff also bears lower Nuremberg archival numbers (A092586 to A092588) than version B (A090025, A090027, A090028; A090026 seems to have been skipped; see on the lower part of each page in Appendix 2). This

---

<sup>33</sup> [www.cwporter.com/501ps.htm](http://www.cwporter.com/501ps.htm).

in spite of the fact that version D had to make a long journey before it could be registered in Nuremberg (Rauff was at that time incarcerated in Italy, see chapter 3.5.2.).

The only thing that makes me suspicious about this is the length to which the Nuremberg prosecution went to get Rauff to certify the authenticity of this one document. To achieve this, they sent this one document across war-torn Europe for the sake of obtaining a brief sentence and signature on it plus a supportive yet rather terse affidavit. This seems to have been quite an unusual procedure, which I have not heard of for any other Nuremberg document. Apparently there was never any intention to have Rauff testify about this in Nuremberg, because in that case they would have moved Rauff himself to Nuremberg rather than the document to him.

All in all, there seem to be reasonable explanations for all the differences in the extant versions. Hence I cannot find any formal reasons to suspect a forgery in this case. This does of course not necessarily mean that the document is genuine. Forging documents is easy, if all the original stationery, office equipment, and a huge amount of original handwritings and signatures are at one's disposal, as was the case for the victors occupying the German authorities' offices after the German unconditional surrender. The proof is in the pudding, as the saying goes, which I will therefore analyze next.

#### 2.2.2.3. Translated Content

In contrast to the Just document, which will be analyzed in chapter 2.2.4., the Becker letter is not subdivided in numbered paragraphs. In order to facilitate its analysis, Pierre Marais has numbered both each paragraph and each sentence in his 1994 study, and I will apply this method here too, as it will facilitate the subsequent step by step analysis of this document's content. This analysis follows Marais' arguments to a large degree.

I do *not* reproduce the official English translation of the Nuremberg Tribunal here, because it is riddled with faulty translations which gloss over the at times absurd contents of the German original.

“Field Post Number 32704  
B. No. 40/42 –

Kiev, May 16, 1942

TOP SECRET!

To  
SS-Obersturmbannführer R a u f f  
In Berlin  
Prinz-Albrecht-Str. 8

1st paragraph:

- 1st sentence: The overhaul of the vehicles at Group D and C is finished.
- 2nd sentence: While the vans of the first group can also be deployed when the weather conditions are not too bad, the cars belonging to the second group (Saurer) are absolutely stranded in rainy weather.
- 3rd sentence: For instance, if it has rained a mere half hour, the vehicles cannot be used because of plain skidding.
- 4th sentence: It can only be used in absolutely dry weather conditions.
- 5th sentence: The question arises now whether one can use the vehicles only on the execution spot while stationary.
- 6th sentence: First, the vehicle must be brought to this place, which is only possible in good weather.
- 7th sentence: But in most cases the execution spot is 10 to 15 km off the traffic routes and is difficult to access already due to its location, [but] during humid or wet weather not at all.
- 8th sentence: If those to be executed are driven or conducted to this place, they notice at once what is going on and become unsettled, which should be avoided if possible.
- 9th sentence: There is only the one way left: to load them up at the gathering point and then to drive off.

2nd paragraph:

- 10th sentence: I had the vehicles of Group D camouflaged as trailer homes by having had window shutters mounted, one on each side of the small vans and two on each side of the big ones, like the ones which are seen on peasant houses in the countryside.
- 11th sentence: The vehicles had become so well known that not only the authorities, but also the civilian population called them ‘death wagons’ as soon as one of the vehicles turned up.

- 12th sentence: My opinion is that even camouflaged it cannot be kept secret in the long run.

3rd paragraph:

- 13th sentence: The Saurer vehicle which I transferred from Simferopol to Taganrog had a brake defect *en route*.
- 14th sentence: At the S.K.<sup>[34]</sup> in Mariupol it was determined that the brake sleeve [“Manchete”] of the combined hydraulic-pneumatic brakes was broken in several places.
- 15th sentence: Through persuasion and bribery at the H.K.P.<sup>35</sup> I managed to have a mould turned, after which two brake sleeves have been cast.
- 16th sentence: When I got to Stalino and Gorlovka several days later, the drivers of the vehicles complained about the same defect.
- 17th sentence: After consulting with the commanding officers of these commandos, I proceeded once more to Mariupol in order to have further brake sleeves manufactured for these vehicles.
- 18th sentence: It has been agreed that two brake sleeves will be cast for each of these vans; six will remain in Mariupol as back-up for the Group, and six brake sleeves will be sent to SS-Untersturmführer E R N S T to Kiev for the vehicles of Group C.
- 19th sentence: For the Groups B and A, the brake sleeves could be obtained through Berlin, as the transportation from Mariupol to the north is too inconvenient and would take too long.
- 20th sentence: Smaller defects of the vehicles will be carried out by technicians of the commandos or groups in a workshop.

4th paragraph:

- 21st sentence: Due to the uneven terrain and the hardly describable way and road conditions, the sealings and rivets become loose over time.
- 22nd sentence: I was asked whether in such cases the vehicle ought to be transferred to Berlin for repairs.
- 23rd sentence: A transfer to Berlin would be too expensive and would require too much fuel.
- 24th sentence: To save such an expense, I gave the order that they themselves solder small leaky spots, and if this could not be done any

---

<sup>34</sup> *Sonderkommando* = special command.

<sup>35</sup> *Heeres-Kraftfahrzeug-Park* = Army Motor Pool.

more, to inform Berlin at once by radio that the vehicle Pol. No... was out of service.

- 25th sentence: Furthermore, I ordered to keep all men as far away from the van as possible during the gassings, in order that they will not be harmed by possibly escaping gases.
- 26th sentence: On this occasion I wish to call attention to the following: after the gassing various commandos let their own men do the unloading.
- 27th sentence: I have drawn the attention of the commanding officers of the concerned S.K. to the tremendous mental and physical harm that this work can do to the men, if not just now then later on.
- 28th sentence: The men complained to me about headaches occurring after every unloading.
- 29th sentence: Nevertheless one does not want to deviate from this decree, as it is feared that the prisoners enlisted for the work could use a favorable moment to escape.
- 30th sentence: In order to protect the men from such harm, I ask to give corresponding orders.

5th paragraph:

- 31st sentence: On all occasions the gassing is not done in the right manner.
- 32nd sentence: In order to get the work done as quickly as possible, the driver gives full throttle.
- 33rd sentence: Through this measure the executees suffer a death through suffocation and not as intended a death by being put to sleep.
- 34th sentence: My instructions have now revealed that death occurs faster and that the prisoners fall asleep peacefully when adjusting the levers properly.
- 35th sentence: Distorted faces and excretions, which have been seen previously, could no longer be observed.

6th paragraph:

- 36th sentence: In the course of the current day I continue my journey to Group B, where further messages can reach me.

(sgd.) Becker  
–Untersturmführer”

#### 2.2.2.4. Analysis of the Content

– 2nd to 4th, 6<sup>th</sup>, and 7th sentence: The last two sentences are pointless repetitions of the first three. Would anyone believe that a truck can be completely incapacitated after just half an hour of rain?

The author of these lines might be hinting at the difficulties the German army faced in the east, but that had little to do with certain trucks skidding about. Road conditions in the Soviet Union were generally catastrophic during the war. There were hardly any paved roads outside of major cities. In addition, the German army was not prepared for the Russian winter, so their motor pool, as everything else, came to a freezing standstill in November 1941. Diesel vehicles in particular, if not filled up with special winter Diesel or alternatively equipped with heated Diesel tanks, fuel lines, and injection pumps (which they weren't), could not move due to the fuel being frozen solid. When the winter finally ended, the upper layer of the frozen soil thawed, yet lower layers stayed frozen for weeks to come. As a result any melt water and rain did not drain, so the entire unpaved road system of the Soviet Union turned into a huge quagmire, in which the German army got literally stuck. It was not before April or May 1942, depending on the region we are talking about, that weather and soil conditions enabled the German army to deploy their vehicles again with some reliability.

Of course everybody involved in the war knew this, as this catastrophic first Russian winter halted the initial German thrust and was one major reason why the Soviet Union did not collapse in late 1941/early 1942.

It is very strange that the Becker document does not even hint at any of this. Instead, already mere humid weather conditions are claimed to have rendered the trucks useless because of skidding, when in fact getting stuck in the mud had been the big problem of all German vehicles. If what the Becker document insinuates here was German army standard during that war, they wouldn't have gotten much farther than Warsaw with that kind of equipment!

– 8th sentence: According to the author of this letter, sometimes the executees had to walk to the execution site, but at other times they were carried there by a vehicle. From this it has to be concluded that the executees and the gas van were at times brought separately to this spot. If the reason for this was that the respective gas van could not drive, then how did the van get to the execution site? Was it left there overnight? And if this gas van couldn't move about, how did the other "normal"



trucks transporting the executees manage to get there? What a logistic mess! I may mention in passing that there is not a single witness statement or court verdict claiming that any victims had to walk to the gas van execution site (see chapter 3).

In addition, no reason is given why the executees became unsettled when walking to their execution site and what would have been necessary to prevent this.

– 9th sentence: This sentence is obscure, since it does not fit into the context. In order to understand the second part of this sentence, it has to be assumed that the executees had been gathered in a building or in a fenced-in area. But would it not have been common, even inevitable practice anyway to pick up those to be executed at a collection point?

– 10th and 12th sentence: It is ridiculous to claim that the mere mounting of window shutters on the sides of the truck would have sufficed to give it the looks of a trailer home. Besides, motorized, truck-size trailer homes weren't exactly a common commodity in Russia in those years, to put it mildly, because in that era trailer homes consisted of horse-drawn carriages! Hence, a truck thusly adorned inevitably would have *attracted* attention instead of diverting it, all the more so as a truck with window shutters, yet without any corresponding windows, would have been a peculiar sight, indeed! Even the author of the letter states shortly afterwards in the 12th sentence that “even camouflaged” such a truck “cannot be kept secret in the long run,” which makes me wonder why such puerile attempts at camouflage would have been undertaken in the first place; after all, the letter's author does not mention an order to that effect.

In chapter 3 we will encounter a number of court verdicts claiming that the gas vans were adorned (as alleged camouflage) with drawn-on windows and even curtains, which was just as puerile and futile, attracting attention instead of diverting it. The first such claim stems from a 1943 Soviet show trial (see p. 116), whose respective statements were later parroted in several verdicts of the Munich district court which gave a kind of rehashed performance of the 1943 Soviet show trial (pp. 116, 231, 233, 236). It may be conjectured that the author of the Becker letter was inspired by this 1943 Soviet claim, although he changed the theme from windows to shutters. If so, this would prove that the Becker letter was written *after* the 1943 Soviet trial.

– 13th sentence: Taganrog at the Black Sea lies some 50 km west of the Russia City Rostov on the river Don; it was occupied by German

troops in October 1941. They pushed farther east into Rostov-on-Don, but could hold that city only for a week due to adverse weather conditions. They were subsequently pushed back to Taganrog. During the subsequent months the Germans had to struggle primarily with “General Winter,” then during the spring thaw with extremely muddy roads which grounded almost all of their motor pool. Up to late June 1942, when the Germans renewed the offensive with “Fall Blau” (case blue), Taganrog was the eastmost frontline town in German hands in the Russian south. Being a frontline town, it was under direct control of the German military front line units, who most certainly would not have tolerated stirring up the civilian population by having gas vans driving around killing civilians. It also seems inconceivable that under these circumstances, with Red Army Units in immediate proximity, the RSHA would have ordered a “gas van” to be sent to a location where they were in danger of being captured by a sudden Soviet counter-attack.

– 14th to 19th sentence: The word “Manchete,” plural “Mancheten” (with ch and a single t) is not part of the German everyday language nor of technical lingo. Dictionaries merely list the word with a “sch” and a double t as “Manschette.” It has several meanings, of which only the technical one is of relevance here, referring to a usually flexible, elastic sheathing for protection, stabilization, or sealing/separation of an item: cuff, sleeve, cast. This term, which appears misspelled seven times in the Becker document, indicates that at least in this context the document talks about real issues, which could corroborate its authenticity.

In order to find out what these items were, Pierre Marais inquired with the Viennese company Steyr-Daimler-Puch (S.D.P.) which had absorbed the Austrian part of the Saurer company in 1959. They proffered the following information (see their letter to Marais on p. 376):

*“The wartime Saurer vehicles were equipped with a vacuum-supported hydraulic brake, as they are still being used in today’s cars and small vans following the same principle.*

*The ‘Manchete’ mentioned was a rubber membrane of the vacuum servo device which tore frequently, leading to the loss of the power support so that the trucks could be braked only with the force of the foot. Hence it is not a total loss, but a diminished efficacy of the brakes.*

*The mould mentioned in the letter did not serve to cast, but rather to vulcanize<sup>[36]</sup> the rubber membrane.”*

This answer gave rise to the following remarks:

*First Point:* That the Saurer trucks had a vacuum-supported hydraulic brake is confirmed by other sources, according to which the Saurer C-class trucks introduced in 1935 and produced until 1955 were all equipped with Diesel engines and had “servo-supported hydraulic brakes; max. load up to 11 tons.”<sup>37</sup>

The term “combined hydraulic-pneumatic brakes” used in the Becker document (*Öl-Luftdruckbremse*; literally: oil/air-pressure brake) implies, however, that the system required a *compressor* in order to generate pressurized air (*Luftdruck*). Although pressurized pneumatic braking systems might have existed in some vehicles, it makes no sense, technically speaking, to combine a pressurized pneumatic system with a hydraulic system, nor is there a precedent for such a combination to my knowledge. But the point is moot, since we know that these trucks had vacuum-assisted hydraulic brakes. The author of the Becker document was obviously not only unfamiliar with the proper terms, but seems to have made up a non-existing technical term in order to appear knowledgeable. This is surprising when considering that Becker himself had claimed that he was allegedly selected from the highest quarters “to pay particular attention to the mechanical functioning of these vans” and went out of his way in order to organize repairs of the brake system.

*Second Point:* The definition of the term *Manchete* fits the context of the document: mentioning damaged sleeves with the resulting effects and with a reference to their frequency is in accordance with the facts and thus does not merit any further comment.

*Third Point:* This confirms that the rubber pieces could not have been cast under the circumstance described in the document, but it still evades me how they could have been vulcanized in their entirety. This would have required that the manufacturing company sent unvulcanized spare part sleeves, which doesn’t seem likely; hence this point remains unclear. One can assume that tears in a membrane could be repaired in a makeshift way by mending them with unvulcanized rubber patches, which were then vulcanized by applying a chemical, as it is done with perforated rubber tubes, but that does not require a mould.

---

<sup>36</sup> Vulcanisation: introduction of sulfur into rubber in order to harden it by crosslinking the individual polymere strands.

<sup>37</sup> [www.saureroldtimer.ch/5000geschichte/5200chronosaurer/index.html](http://www.saureroldtimer.ch/5000geschichte/5200chronosaurer/index.html).

The irrational expressions used in the Becker document about turning a mould and the casting of a sleeve in it are therefore conspicuous. Most likely the author of this document knew only that the Saurer trucks frequently broke down due to damaged sleeves – that couldn't have been a secret – but he obviously had no idea what these items really were. This leaves us with two options: Either the author and signer of said report was technically ignorant and quite naïve, or else we are dealing with a crude forgery clumsily using a characteristic of the wartime Saurer trucks, which was well-known to their drivers back then, in order to give it some realistic content. Considering all the peculiarities of this document, I am inclined to posit the second option.

– 15th sentence: Although the author of the letter can claim mitigating circumstances for his act of bribery due to the described situation, it is very strange that an SS officer admits *in writing* to a higher-ranking superior to have acted that way, all the more so since by so doing he also incriminates the responsible person of the workshop, who has acted for far less unselfish motives than the author himself.

– 20th sentence: the author probably means that repairs will be carried out, not defects.

– 21st sentence: It is not specified what kind of sealing is meant. Concerning rivets it should be noted that it is highly unlikely that they became loose as a result of the “uneven terrain” and the “hardly describable way and road conditions”: Bolted connections can become loose – this happens frequently – yet rivets hardly ever do. But if they do, such damage is often serious, as loose rivets cannot be repaired but have to be replaced, and while becoming loose, they often widen the holes into which they were fastened. This gives the impression that the author let his fantasy run loose without bothering about the probability of his claims.

In this context it is worth noting that many witness testimonies and subsequently many court verdicts claim that the cargo boxes used were merely lined with sheet metal on the inside, which means that the cargo box itself was made of wood, since a sheet metal lining would have been superfluous, had the box been made of metal. Hence, if we follow the majority of anecdotal evidence, it would have been the sheet metal lining which, according to the Becker document, had become leaky and needed to be soldered to keep it airtight.

– 22nd, 23<sup>rd</sup>, and 24th sentence: Fissures in metal plates are not sealed by soldering but rather by welding. Such repair work could have

been done at the spot, so that it is incomprehensible why the vehicles had to be sent to Berlin for such a repair work.

The perseverance with which the author insists on the issue of sealing the gassing box is noteworthy when considering that gas vans used for homicidal gasings could have worked only, if the *sealed* cargo box, which sported a *sealed* door – the witness statements emphasize this over and over again – had openings permitting the *escape* of the excess exhaust gases (see chapter 1.3.2.), which is to say: they *could not* and *should not* have been sealed!

– 25th sentence: By referring to “possibly escaping gases,” the author once more confirms his underlying hypothesis that a proper operation of a gas van required as sealed cargo box, as this phrase implies that under normal conditions of the gassing operation no gases escape near the vehicle. But as already described in chapter 1.3.2., an engine whose exhaust pipe is connected to a sealed cargo box will bend and eventually blow the box apart. Hence we have a physically or mechanically impossible claim here.

Not to mention the fact that “possibly escaping gases” could not be more dangerous for those operating the vehicle than the inevitable inhalation of exhaust gases of city traffic or of the idling engine of a stationary vehicle.

– 26th to 29th sentence: The author bemoans that the unloading of the gassing victims, which does “tremendous mental and physical harm” to those doing it, is sometimes performed by his men, and he suggests that orders are given to have inmates do this work. But according to mainstream historiography, the killing method “gas van” had been invented precisely because of the following reason:

*“However, the mass shooting of Jews, Gypsies and other Soviet citizens affected the morale of the Einsatzgruppen (operational groups) that carried out the executions behind the front-line troops.”* (Kogon et al. 1993, p. 52)

In the same anthology Walter Rauff is quoted as follows:

*“At the time to most important consideration for me was the psychological stress felt by the men involved in the shootings. This problem was overcome by the use of gas vans.”* (*ibid.*, p. 53; see chapter 3.5.2.)

I may point out that the last sentence from the above quote allegedly stemming from Rauff is in blatant contradiction to the 27th sentence of the letter at issue, which was addressed precisely to Rauff!

In 1980 the Munich District Court stated that

“[...] later, about early summer 1942 and on orders from the Imperial Security Main Office, the so-called gas van was used for the killings in order to save ammunition and to spare the members of the commandos the terrible scenes of the executions.” (Rüter *et al.* 1968ff., vol. 44, p. 250)

From this we ought to conclude that the execution method used previously – shootings – which is common practice during wartime, caused even more mental and physical harm to those charged with it.

As we will see when dealing with various court cases, the situation is contradictory and confusing indeed; while some witnesses or verdicts stated that gas vans replaced shootings due to gassings being less stressful for the executioners, others stated that gas van executions were eventually abandoned (or never implemented to begin with) because this method of killing was allegedly even worse than shootings (see *e.g.* chapters 3.7.3.1. and 3.7.5.2.). However, I have not found a single occasion where the unloading is said to have been done by SS men.

With regard to jeopardizing their physical health, the respective men could inhale only insignificant amounts of exhaust gases when opening the doors, and since the operation took place outdoors, the risk was minimal in any case.

– 32nd sentence: This sentence implies that the gassings took place while the trucks were stationary, because a driving truck cannot be operated at “full throttle” all or even most of the time. This in turn implies that the truck’s engine was running without any load. In case of Saurer trucks with Diesel engines, their exhaust gases would not have had toxic amounts of carbon monoxide under these circumstances; hence they would have been unsuited for murder by asphyxiation (see chapter 1.3.1.). This way the victims could only have been very slowly cooked to death with the hot gases.

– 33rd & 34th sentence: These sentences make no sense at all, since the cause of death is suffocation under any circumstances. “Putting to sleep” by means of poisonous gas is merely a euphemism for asphyxiation. While it cannot be argued that suffocation under the described conditions can occur while the victims were either awake or asleep, no reason can be seen how “adjusting the levers properly” could have an influence on the drowsiness of the victims.

We must keep in mind that Diesel exhaust gases of yore have always been full of smoke and irritants under *any* circumstances, which arouse

people rather than lull them to sleep. It was therefore technically impossible to adjust such an engine in such a way that it would have produced exhaust gasses capable of putting anyone to sleep peacefully.

It is not even clear what “levers” (plural) the author is talking about. The truck had only one accelerator pedal, and that is called “*Gaspedal*” or simply “*Pedal*” in German, not “*Hebel*.” One court verdict mentions the adjustment of a stationary vehicle’s idling speed (*Standgas*), probably by means of a hand throttle or choke, but as evidence for this it quotes the Becker document (Rüter *et al.* 1968ff., vol. 33, p. 284), so we are going in circles here.

Even though pulling the choke would have increased the engine’s rpm while idling and hence the amount of gas produced, it would have had no significant effect on the composition of the exhaust gases. The same is true if the driver of a stationary truck gave “full throttle,” as the Becker document mentions (on this see Berg, in Rudolf 2003, p. 447). The only effect would have been that the gassing box had been filled faster with the hot but non-toxic Diesel exhaust gases. But the amount of gas produced by the position of the accelerator or the choke has neither an influence on the time it took for suffocation to occur nor on the circumstances under which death set in, that is, whether the victims fell asleep or remained awake, whether they ended up having distorted faces or not, or whether they lost control of their bowel movements or not.

It is, by the way, astounding that the National Socialist hierarchy even bothered with such humanitarian consideration in this context and allegedly tried to achieve that the victims fell asleep peacefully and forever, or so the Becker document suggests. But since adjusting the levers properly wouldn’t have had any effect anyhow, this story is simply untrue. The real reason why the author included this tall tale was probably to give the impression that he is talking about real events. But since the claims are nonsense, this exposes the author as a liar.

The reference to these “levers” probably inspired later “witnesses” to confabulate about some undefined levers used to initiate the piping of exhaust gases into the cargo box, as we will see later on.

– 35th sentence: as mentioned in chapter 1.3.1., Diesel exhaust gases are not only hot but also full of smoke and irritants so that no matter which way one *tries* – with or without success – to suffocate anyone with them, it is going to be torture. Hence, quite contrary to what the author of the Becker document claims, it must be argued that, the faster death occurs, the less time the victims have to suffer and panic; “full

throttle” would therefore indeed have been the best advice, if it could speed up the process at all, which it couldn’t.

The analysis of this letter leaves behind an awkward impression. This impression as well as the criticism I have expressed about each point prompt me to doubt the authenticity of this letter.

I will now turn to the other documents which form part of 501-PS.

### 2.2.3. The Telegrams of 501-PS

#### 2.2.3.1. Two Versions

The texts of the telegrams of 6 and 15 June 1942 exist in two different versions, which are reproduced consecutively in IMT vol. 26 (pp. 106-109). Since the documents reproduced in the IMT volumes have been retyped rather than photographically reproduced, I will subsequently refer to the alleged originals of these documents as archived in the U.S. National Archives.

Both versions of each telegram bear handwritten marks, which give the impression that both versions were prepared in the offices of the RSHA in Berlin. Version A of the telegram of 9 June 1942 – the one reproduced first in the IMT volume – is typed on the *lower* half of a sheet of paper, while version B of the *later* telegram of 15 June 1942 is typed on the *upper* half; hence they were apparently typed counter-chronologically. Although there were six days between the receipts of these two telegrams, and although 7749 other telegrams arrived at the RSHA in the meantime (or so the serial numbers suggest: version A 144,702, version B 152,452), somebody must have taken the trouble to pull out these two telegrams and retype them in inverted chronological order on a separate sheet of paper. Even the handwritten note “Repair immediately after return – report completion” was added at the top left corner to the retyped telegram of 9 June 1942, although apparently by a different writer than the one which is on the other, ostensibly original version. This version also includes a red underlining of the address line (so the footnote in MT vol. 26, p. 106), whereas version B of this telegram has the secrecy note beneath the address line framed in red (*ibid.*, p. 108, footnote).

#### 2.2.3.2. 9 June 1942 from Belgrade

Apart from the Turner letter, which I will discuss in chapter 2.2.7., this is the only documentary evidence hinting at the use of special vehi-



cles (*Spezialwagen*–Saurer) in Serbia, although the telegram’s content gives no indication as to what exactly was special about it.

In the subsequent English translation I have removed the upper case style and fixed some typos to make it easier to read (see Appendix 3 for the German text):

*“To the R.S.H.A. Office Roem 2 D 3 KL. A—to att. of Major Pradl – Berlin .—*

*Re.: Special wagon–Saurer.—*

*Dossier: none.—*

*The motorists SS– Scharf. G o e t z – a. M e y e r have accomplished the special order, hence the[y] named can be [are] ordered back with the above mentioned vehicle. Due to cracked axle of the rear half of the axle a transfer per axle [cannot take place].—*

*I have therefore order that the vehicle is transferred back to Berlin loaded on the [by] railway.*

*Expected arrival between the 11. a 12 6. 42 The motorists Goetz a. Meyer accompany the vehicle.—*

*The Comm. of SIPO a. the SD<sup>[38]</sup>– Belgrade– Roem 1 – BNR. 3985/42 42*

*sgd. Dr. Schaefer– SS– Oberstubaf–”*

The telegram also contains a handwritten note in the upper left corner reading:

*“Repair immediately after return. Report completion.”*

Version A of this telegram’s text, which was typed on the lower half of a separate sheet of paper – with the text of the telegram of 15 June 1942 in the upper half – sports a typo not contained in version B. It reveals the originator of this retyped version: the second occurrence of the word “*Fahrzeuge*” (vehicle) is mistyped as “*Fahryeug*.” This is a common mistake of a German typing on an English typewriter or vice versa, because on German typewriters the position of the Z and Y are swapped in comparison with their position on an English typewriter. A second typo also included in version A but not in version B is located two words earlier, which sports a question mark instead of a comma. Since the telegram was typed in upper case, this indicates that the typist accidentally forgot to release the upper case key (or unlock the caps lock). And in fact, old German mechanical typewriters had the question mark as the upper case alternative of the comma. Although this was not the

---

<sup>38</sup> SD stands for *Sicherheitsdienst* – security service.

case for all English typewriters of that age, some did have the same comma/? combination as the German typewriters.<sup>39</sup>

Hence, although this cannot be said with certainty, the most likely scenario here is that an Anglo-Saxon typist wrote this telegram on a German machine. The less likely scenario is a German typist writing on a somewhat rare English typewriter. The almost impossible scenario is a German typist writing on a German machine or an English typist on an English machine, because then the accidental swapping of Y and Z wouldn't have happened.

It is therefore reasonable to assume that this retyped version was created by either a person normally typing on an English typewriter but in that occasion using a German model, or a person used to typing on German typewriters, but in that case using a somewhat rare English typewriter. This means in plain English that the versions A of the two telegrams were probably (re?)typed after the war in a setting of a mélange of Germans and Anglos-Saxons as well as German and English typewriters. This wouldn't be a problem, if this sheet of paper didn't have a number of German handwritten remarks on it giving the impression that this document is an original created in 1942.<sup>40</sup> So it is either an incompetent way of creating a copy of the originals – but why are they then part of the set of “original” documents? – or these handwritten remarks were meant to look real and are therefore fake. Hence, the most likely scenario is a person used to English typewriters writing on a captured German typewriter. Hence this summary sheet is suspicious.

Another indication that this telegram is not authentic are the names of the two drivers mentioned: Götz and Meyer. To this day no such individuals who are said to have been employed as drivers by the RSHA have been identified. This stands in stark contrast to other individuals who were never mentioned in any document as gas van drivers but who were nevertheless identified somehow and were even prosecuted for allegedly driving such vehicles (see chapters 3.6.4., 3.7.4.1., 3.7.4.10f.). This indicates that the drivers mentioned in this telegram probably nev-

---

<sup>39</sup> A Google image search of typewriters shows that some old typewriters had a comma/? combination, while others had today's layout. I don't know when that combination was changed to today's standard.

<sup>40</sup> The red underlined address line already mentioned plus at the top right: “II D 3a Major Pradel Niederhausen (Kop)”; at the right margin below the dotted page halving line: “Nach Rückkehr sofort wieder instandsetzen- Fertigstellung melden (Kop)” = Repair immediately after return – report completion (Kop).

er existed. Browning has hidden this important fact in a footnote (Browning 1983, p. 79, fn 75):

*“All attempts to trace the drivers, Götz and Meyer, have been unsuccessful. The few gas van drivers who have been identified were full-time Sipo-SD drivers subsequently assigned to gas van duty.”*

The reverse of this telegram (version B, the ostensible original) has the following handwritten text:

*II D 3a (2) Berlin, 11 June 42*

*c/o Pr. Sukkel for further action and immediate initiation of repairs. I request to be informed of the arrival of the vehicle.*

pp. Just

*II D 3a (9) Berlin, 16 June 42*

*Note:*

*The vehicle arrived here on 16 June 42 around 13.00. Repairs will be initiated immediately after thorough cleaning.*

pp. [signature illegible]

*II D 3a 9 Berlin, 13 July 42*

*1. Note: The S-vehicle reg. no. 71463 has been completed ~~and is to be sent to Riga with the driver.~~*

*2.) Sent to head of motor pool T.J. Niederhausen with the request to take note and for further action.*

pp. [signature illegible]

### 2.2.3.3. 15 June 1942 from Riga

*“To the RSHA. – ROEM. 2 D 3 A – Berlin.–*

*Secret State Matter.—*

*Re. S.–Wagon.–*

*At the commander of the SIPO a. the SD. Belarus a transport of Jews arrives weekly which is to be subjected to a special treatment.–*

*The 3 S-wagons existing there do not suffice for this purpose. I request the allocation of another S-wagon (5 tons). Furthermore I request at once to also send 20 exhaust hoses for the existing 3 S-wagons (2 Diamond, 1 Saurer), as those available are already leaky.*

*= =*

*= The Comm. of SIPO a. the SD. Ostland*

*Roem. 1 T – 126/42 GRS. [secret state matter]*

*A. sgd.: Truehess. HStuf. [correct: Truehe, SS HStuf.]*

*Task: [handwritten:]*

- 1) *When can the deployment of another S-wagon be expected?*
- 2) *Are spare exhaust hoses available, on order or when deliverable?*
- 3) *submit draft for answer*"

It is from this document that the claim arose that the Germans used trucks built by the U.S. company Diamond as gas vans. Although Diamond was a big player in the U.S. truck market in the 1930s and during the war, no U.S. truck company ever exported trucks on a considerable scale to European markets. There may have been a few selected Diamond trucks in Germany, and if so, they were probably vehicles with extraordinary designs rather than trivial trucks, but the probability that any of them ended up being used as gas vans was minute. In addition, since Germany could not get any spare parts for these trucks after the entry of the U.S. into the war at the end of 1941, these vehicles would probably not have been used for anything requiring reliability. It is therefore much more likely that the name Diamond was entered in this "telegram" by a writer who thought that using one of the best-known truck models – best known to him – was a wise thing to do. Since Saurer was a well-known name for Diesel and gas generator trucks in Germany, it cannot surprise to see this name mentioned in the telegram either, all the more so as the name "Saurer" had already been mentioned during the war in Soviet show trials as the make of gas vans used in the USSR. (I will return to that in chapter 3.5.1., p. 129.)

Hence, apart from the typo replacing a Z for a Y in the summary version of the first telegram, here we have another indication that the mastermind behind the creation of these documents was probably Anglo-Saxon (i.e., U.S.-American) in nature rather than German.

It should also be noted that the telegram's claim that three existing trucks were insufficient to "process" the incoming weekly transports is untenable. Each of these transports contained some 1,000 people (Matogno/Graf 2005, pp. 200f.; Rüter *et al.* 1968ff., vol. 19, p. 195), so if we assume five workdays a week, each van had to treat  $(1,000 \div 5 \div 3 =)$  67 people, which amounts to one gassing each day. It is therefore pure nonsense that "the 3 [existing] S-wagons existing there [did] not suffice for this purpose." That shows that this telegram was produced in order to make the alleged ongoing mass murder look even bigger than it theoretically could have been, if all deported individuals had indeed been gassed. This is yet another indication that the telegram has its roots not in reality but in the imaginations of propagandists.

## 2.2.3.4. 22 June 1942 from Berlin

This is the draft for an outgoing telegram allegedly sent to Riga in response to their request for more trucks:

*“Reichssicherheitshauptamt* *Berlin, 22 June 1942*  
*II D 3 a B. No. 240142 s[ecret] S[tate]M[atter]*  
*Secret State Matter!*

1.) *T[ele]G[ram]*

*To the Commander of the Security Police and the SD Ostland  
 in Riga*

*Subject: S Wagon*

*The transfer of a 5 t Saurer can be expected middle of next month. The vehicle is currently at the Imperial Security Main Office for repairs and to make minor changes. 100 m hose will be sent along.*

*p.p.*

*(signature as head)*

2.) *F[ollow-]u[p]. immediately at II D 3 a (9)*

*p.p.*

*Rauff*

[page 2]

*Tasks:*

- 1) *When can the deployment of another S-wagon be expected?*
- 2) *Are (?) exhaust hoses available, on order or when deliverable?*
- 3) *submit draft for answer”*

The typed text on page two is a copy of what had been handwritten below the Riga telegram, where the typist couldn't discern the word “spare” (German: *Reserve*).

This document is the link between the two telegrams discussed before, as a handwritten note on page one of the original allegedly states:

*“No. T. J Niederhausen for further action and please note the remark of 13 July 42 on the back of the telegram from Belgrade. For technical reasons only five rings of 10 m each can be sent.”*

The remark of 13 July 1942 mentioned that the truck sent back from Serbia had been repaired and that it is to be sent off to – where exactly? The telegram requesting the van came from Riga without indicating that the vans ought to be sent elsewhere, so Berlin had to assume that the van had to be sent to Riga. That this was indeed initially anticipated is

shown by the handwritten remark on the back of the Belgrade telegram (see chapter 2.2.3.2.). Fact is that all except one of the mentioned deportation transports to be “processed” went to Minsk, not Riga, which is therefore where the vans would have been needed. This may be the reason why this part of the sentence was crossed out. Yet still, it is striking that the most important information needed to send the van on its way – its destination – is not mentioned anywhere.

What is strange as well is this document’s request on page 2 under #3 to submit a draft for an answer, even though it already contains the very answer to the telegram from Riga on its page 1.

### 2.2.3.5. Leaky Exhaust Hoses

Flexible metal hoses, which are commonly referred to as exhaust, ventilation or suction hoses, are usually made of thin, sometime zinc-plated steel bands coiled up like a spiral.<sup>41</sup> They overlap at the edge, where they interlock in a groove. Although this gives them some flexibility, such hoses are neither gastight (unless especially sealed) nor pressure resistant. Apart from funneling gases, these hoses are also used to transport free-flowing solids (grains, powders, pellets, granules, etc.), which would wear down rubber or plastic hoses too fast. Characteristic for these metal hoses was their relatively low flexibility.<sup>42</sup> In the present case, where the hose is said to have made a 90° bent from the horizontal exhaust pipe to the cargo box floor, this low flexibility would have made an installation difficult, and the metal hose bending first downward from the exhaust pipe and then in an arch back upward toward the floor opening would be in danger of hitting the road surface (see Illustration 26, p. 378). A technician wearing his thinking cap would therefore either have installed an L-shaped pipe in the floor to avoid having to bend the hose, or better still, he would have connected the cargo box with the exhaust pipe through a hole in the lower side wall (beneath the grate), thus also eliminating the risk of items falling or fluids flowing into this pipe. Such a connection would have required only a bend shaped like a flat ~ in the metal hose, if such a hose was necessary at all.

---

<sup>41</sup> Some of today’s exhaust hoses are even made of high-temperature resistant plastics or mineral fibers, but such materials did not yet exist during the Second World War.

<sup>42</sup> Although today’s hoses are quite flexible and usually also sealed, cf. [www.flextraction.co.uk/pdfs/hoses/metal-hoses/Metal-Hose-375-Special-Fibre-Seal.pdf](http://www.flextraction.co.uk/pdfs/hoses/metal-hoses/Metal-Hose-375-Special-Fibre-Seal.pdf).

This brings up the next point: Neither does the normal configuration of an exhaust pipe require a hose and usually doesn't have one either, nor can a reason be seen why it is absolutely necessary to use a metal hose in order to convert a van into a "gas van." The exhaust pipe could have been readily connected to the cargo box with a solid pipe, where simple devices suffice to permit a thermal expansion. A reversible connection of the exhaust pipe to the cargo box would have been required, however, if occasionally the truck's cargo box was to serve also as a normal transport device, as I have explained on page 37. And in fact, a number of court verdicts claim that the gas vans were first driven to an execution site with the victims locked up inside the cargo box, but that the gassing itself occurred only after arrival, when the vehicle was stationary again (see chapter 4.2.7.). Whether such a procedure would have made sense and would have been efficient is a question I will not discuss here.

An absolute necessity for flexible metal hose would have existed only, if the cargo box had a special design requiring the exhaust system to be both connected to it *and* moveable. However, in all the witness testimonies I have encountered only one claims a movable cargo box, here a cargo box that could be tipped in order to unload its cargo (Kogon *et al.* 1993, p. 70). But even that could have been done after disconnecting the exhaust system from the box. In addition, this statement stands in such crass contradiction to all other witness statements and to the extant documents that it can safely be disregarded.

Since metal hoses for hot aggressive gases were zinc-plated, they could resist corrosion relatively well. Dangerous to exhaust pipes and hoses are primarily acidic components of the exhaust gas itself, like nitrous and sulfuric oxides, which, if dissolved in water, form highly aggressive acids. Water in exhaust pipes and hoses forms primarily during the first minutes of operation, when the exhaust system is cold and water contained in the exhaust gas condenses inside of it. Major amounts of fluids that have accrued inside the pipe due to other reasons would have been blown out right at the start of the engine.

Although the "telegram" gives no reason why the hoses were leaking, the Just document analyzed in the next chapter suggests that "acruing fluids" were responsible for this. It could be hypothesized that human body fluids are meant with this, but it is a fact that such fluids – urine, blood, feces, saliva – are not corrosive in any way. As a matter of fact, the ammonia which develops from urine, the main body fluid to be

expected in a hypothetical mass murder scenario, is slightly alkaline and would therefore *reduce* the corrosion of the acidic exhaust gases by neutralizing them partially.<sup>43</sup>

Hence it takes years before metal exhaust hoses or pipes rust through, in particular if they are zinc-plated. Why then did Riga request 20(!) new exhaust hoses for three trucks, and Berlin was prepared to sent 100 m (which amounts to an individual hose length of 5 m), although they had to reduce that amount “for technical reasons” to just 5 m × 10 m. This would mean that these hoses were expected to become leaky again after just a few months. Was someone slashing them with axes or knives? Or were they really dangling so low that they scraped the roads?

I want to point out moreover that the one information which the Berlin recipient of the telegram from Riga really needed in order to supply these exhaust hoses is not included: their diameter, as such hoses come in a broad variety. Considering that two unusual Diamond trucks had to be equipped with them, this information would not have been easy to come by and could not be expected to be known by some pencil pusher in Berlin.

#### 2.2.4. The Just Document, 5 June 1942

This file memo is one of the documents contained in the dossier R 58/871 f° 1 of the German *Bundesarchiv* in Koblenz which comprises 22 pages altogether. This dossier contains correspondence regarding “special vehicles.”<sup>44</sup> The document quoted below has been reproduced in the German edition of Kogon *et al.* in its entirety (1983, pp. 333-337). The French and English editions contain only a reproduction of the first page and a translation of the complete text (Engl.: 1993, pp. 228-231).

Ingrid Weckert has analyzed this document as well in her two papers (1985, pp. 23-28; 2003, pp. 231-236). My subsequent analysis is based to a sizeable part on Marais’ observations.

---

<sup>43</sup> On the corrosive effect of various chemicals on steel see [www.engineeringtoolbox.com/metal-corrosion-resistance-d\\_491.html](http://www.engineeringtoolbox.com/metal-corrosion-resistance-d_491.html).

<sup>44</sup> See the German original in Appendix 4.



2.2.4.1. Translation<sup>45</sup>II D 3 a (9) No. 214/42 g. Rs.

Berlin, June 5, 1942

Onliest Copy.

Top Secret!
-------------

I. M e m o:

Regarding: Technical modifications to the special vehicles deployed in service and in the process of construction.

For example 97,000 were processed since December 1941 with 3 deployed vehicles without any defects in the vehicles becoming apparent. The known explosion at Kulmhof [=Chełmno] has to be assessed as a single case. Its cause is to be ascribed to an operating error. In order to avoid such accidents, special orders have been issued to the offices concerned. The orders have been kept in such a way that the degree of security has been increased considerably.

The other experiences made so far let the following technical modifications appear to be expedient:

- 1.) To allow for the rapid inflow of the carbon monoxide while preventing excessive pressure, two open slits of 10 cm × 1 cm [4" × 0.4"] are to be located in the upper back wall. These are to be covered on the outside with easily movable hinged metal flaps in order to allow for self-regulation of any potential excess pressure.
- 2.) The vans' load usually amounts to 9 to 10 per m<sup>2</sup> [10 sqft]. Although no overloading occurs thereby for the spacious Saurer special vehicles, utilization in that form is not possible, because their off-road capability is highly reduced by this. A reduction of the load area appears to be necessary. This will be achieved by shortening the body by approximately 1 m [39"]. The above difficulty is not to be solved, as has been done so far, by reducing the number of units. This is because a reduction in the number of units necessitates a longer operation time, since the empty spaces also have to be filled with carbon monoxide. In contrast to this, a substantially shorter operation time suffices in case of a shorter loading area and a completely filled loading space, since free spaces are absent.

In a discussion with the manufacturer it was pointed out by the latter that a shortening of the cargo box would result in a disadvan-

---

<sup>45</sup> Since several versions of this document have different passages underlined, hence are probably later additions, underscores have been omitted here altogether.

tageous weight displacement. It was emphasized that an overloading of the front axle occurs. In fact, however, an unintended balancing in weight distribution occurs, because during operation the load striving towards the back door always predominantly lies there. Due to this an additional load on the front axle does not occur.

- 3.) The connecting hoses between the exhaust pipe and the vehicle frequently rust through, because they are corroded on the inside by accruing fluids. To avoid this, the filler pipe is henceforth to be mounted in such a way that introduction proceeds from above downward. This will prevent the influx of fluids.
- 4.) To allow for easy cleaning of the vehicle, a tightly closeable drain opening is to be located in the center of the floor. The drain cover with about 200 to 300 mm [8" to 12"] in diameter is to be equipped with a U-trap so that thin fluids can also drain out during operation. In order to prevent clogging, the U-trap is to be equipped with a sieve on top. Thick dirt can be rinsed off through the large drain opening during cleaning of the vehicle. The vehicle's floor has to slant slightly toward the drain opening. This is to ensure that all fluids flow toward the center immediately. Thus it is largely prevented that fluids enter into the pipes.
- 5.) The observation windows installed so far can be omitted, as they are hardly ever used. During construction of further vehicles, this omission of the windows saves substantial labor time with regard to their difficult installation and sealing.
- 6.) The lighting appliances are to be more strongly protected from destruction than they have been so far. The iron grid guard over the lamps is to be domed enough to render damage to the lamp window no longer possible. From practical experience it was suggested that the lamps should be omitted altogether, since they are allegedly never used. It was found out, however, that, when the back door is closed, *i.e.*, when it gets dark, the load always urgently strives towards the door. This is because, at the onset of darkness, the load strives towards the light. This renders it difficult to latch the door. It was established that a din always breaks out at the point when the doors are closed, probably due to the eerie nature of darkness. For this reason it is expedient to turn the lights on before and during the

first minutes of operation. The lighting is advantageous also during operations at night and for cleaning the vehicle's interior.

- 7.) In order to achieve a faster and easier unloading of the vehicle, a retractable grate is to be installed. It is to be guided on small wheels in U-shaped iron rails. The extraction and retraction has to happen by means of a cable winch mounted below the vehicle. The firm commissioned with this installation considers this design to be unfeasible at this time due to a lack of personnel and material. The implementation is to be suggested to another firm.

The above mentioned technical modifications are to be implemented for the vehicles in service only, if one vehicle has to undergo a different major repair. The aforementioned modifications are to be considered as far as possible for the 10 commissioned Saurer chassis. Since the manufacturer has emphasized on occasion of a consultation that technical modifications are currently not possible or only for minimal modification, it ought to be tried, using a different company, to equip at least one of these 10 vehicles with all the improvements and modifications resulting from practical experience made so far. I suggest commissioning the firm in Hohenmauth with the single implementation.

Considering the circumstances, a late completion has to be expected for this vehicle. It then has to be kept available or to be deployed not only as a model but also as a back-up vehicle. In case it proves reliable, the other vehicles are to be withdrawn from service one by one and are to be converted following the model vehicle.

## II. Group Leader II D

*SS-Obersturmbannführer Rauff*

submitted for your attention and for adjudication.

p.p.  
Just

Su 4/6  
wa"

### 2.2.4.2. Analysis

#### 2.2.4.2.1. Form

Ingrid Weckert was the first to thoroughly criticize this document, to which I refer the interested reader (Weckert 1985, 2003). I will give a summary of some passages of Weckert's most recent paper below. But

it suffices to have some elementary knowledge of the German language in order to spot anomalies and errors in this document.

First of all there is the non-existing superlative “onliest” (“*einzigste*”) used in the letterhead (although this is quite a common error in German colloquial speech). Much stranger is the expression “for example” used in the letter’s first sentence. As Ingrid Weckert pointed out correctly (2003, p. 233):

*“It makes no sense to begin a letter with ‘for example’. The term ‘for example’ has meaning only when something was described or claimed in the foregoing, for which an example then follows. In this particular case ‘for example’ cannot even refer to the ‘re.:’-line; the ‘re.:’-line speaks of technical modifications which are necessary, but the text immediately states that no defects have occurred in the vehicles. And that is not exactly an example to demonstrate the necessity for technical modifications!”*

Other than being a nonsensical initiation of a letter, the implication of using “for example” in the first sentence is that the 97,000 processed units are only one example among several. Yet the author leaves the reader in the dark about what this “several” could have been.

It is interesting to note that Kogon *et al.* committed their own forgery twice in their book by omitting these telltale words “for example” altogether with no hint at the fact that they have omitted anything (1993, pp. 55, 228).

Furthermore the word “*Siphon*” is misspelled with a “y” (which, by the way, is one English way of spelling it); the word “*weitgehendst*” should actually be “*weitestgehend*,” although this mistake has become part of the German vernacular, hence could not cause suspicions on its own.

The word “lamp window” (“*Lampfenfenster*,” paragraph 6) is neither part of the German language nor of technical lingo nor does it make sense. It should be “*Lampenglass*” (lamp glass) or “*Lampenschirm*” (lampshade).

The word “*Syphonkrümmer*” (siphon elbow pipe) is a pleonasm, as a “*Siphon*” already refers to a U-shaped pipe, hence there is no need to add “*Krümmer*” to it (literally: bender, meaning a bent pipe).

These first remarks raise the question whether the author of these lines was a native German speaker and whether he was a technician. No less justified is the question: who writes to whom here? The first line of the letter seems to contain the abbreviation of the organization creating

this memo: II D 3. The recipient is mentioned unequivocally and by name: the leader of group II D. According to Uwe Dietrich Adam (1985, p. 241), II D 3 refers to “the section automotive transports [...], subordinate to the section for technical matters.” The signatory, Just, therefore signed a letter sent to one of his superiors, yet the tone of the memo does not confirm this assumption: Although the author starts out with a statement of accounts, he increasingly slips into the role of a man who is giving orders rather than receiving them.

No indications are given in the instruction that this memo was accompanied by enclosures (in this case the word “enclosure(s)” (*Anlage(n)*) or the respective abbreviation (*Anlg.*) had to be included in the document), yet as we will see during the study of its content, the questions dealt with would have required several drawings and schematic illustrations. The memo does not have the features of a general instruction – for this it goes too much into details: diameter of the siphon, position and size of the slits; nature of the flaps; extraction and retraction of the retractable grate, etc.

These preliminary observations are meant to alert the reader to the highest degree of vigilance during the subsequent study of the content of this document, which exhibits so many formal peculiarities.

#### 2.2.4.2.2. Content

Let us first look at the very first words of this document: “For example 97,000 were processed since December 1941 with 3 deployed vehicles.” During my analysis of the Becker letter (p. 48) I explained already the catastrophic conditions which the German army had to deal with in Russia during the winter 1941/42. Hence, processing 97,000 units (or even several such amounts) under these conditions would not have been trivial at all, if considering that during the Russian winter the majority of the German equipment was unoperational due to the extreme cold, followed by a spring when catastrophic roads conditions did not permit any major German operation. Hence already the three words “Since December 1941” render this first sentence historically unlikely.

The objects of the memo at issue are technical questions; six modifications to existing vehicles as well as one for those to be manufactured in the future are suggested:

- 1) adding slits and flaps;
- 2) shortening the cargo box;
- 3) relocating the exhaust gas filler pipe upwards;

- 4) adding a drain in the floor and slanting the floor toward it;
- 5) removing observation window (in future vehicles);
- 6) better protected lamps;
- 7) adding a retractable grate.

Before discussing these suggested changes, let me first direct our attention back to the first sentence about the 97,000 processed units.

The second chapter of *Nazi Mass Murder* bearing the title “A Code Language” (Kogon *et al.* 1993, pp. 5-12) deals with the alleged code terms used by the “Nazis” in order to hide the “extermination.” Doubtlessly in keeping with this, the author of this memo has not stated in his introductory sentence with the 97,000 figure, what kind of “units” are meant. Yet this measure of precaution was most naïve and futile, as it becomes subsequently all too clear that only human beings can be meant by those “processed.” (Let’s keep in mind here that this introductory paragraph serves the function of a statement of accounts and is as such directed to superiors.)

97,000 “units processed” within six month (180 days) in three vans means that each truck had processed  $(97,000 \div 3 \div 180) \approx 180$  units every single day, which amounts to three “loads” daily per truck of 60 victims each.<sup>46</sup> Considering this result, which must have been very satisfactory in the eyes of those responsible for this operation, one can only be surprised by the demand for so many and certainly important modifications to the vehicles which have accomplished these “achievements” “without any defects [...] becoming apparent.”<sup>47</sup> If they operated as flawlessly and efficiently as the author claims in his first sentence, why change them? Remember: If it’s not broken, don’t fix it!

---

<sup>46</sup> The wartime Saurer heavy goods vehicle had a maximum load capacity of 5 metric tons, although the RSHA letter of 27 April 1942 mentions 4.5 metric tons (see Appendix 4, which amounts to 60 people of 75 kg each, or 75 people of 60 kg each).

<sup>47</sup> A flawless operation on such a grand scale indicates that the engines were operated normally, quite in contrast to claims made by Georges Wellers, who writes in Kogon *et al.* (pp. 281f.): “In the ‘S-Wagen’ and in the first gas chambers of the extermination camps, exhaust gases rich in carbon oxide produced by deliberately maladjusted engines were used.” It is unlikely that such deliberately maladjusted engines would have functioned flawlessly for an extended period of time; such maladjusted engines tend to overheating, misfiring, and explosions of explosive fuel/air mixtures in the exhaust muffler. Such engines also have a greatly reduced power while consuming exorbitant amounts of fuel. It is, moreover, known that the flooding of the engine with excessive amounts of fuel leads to excessive wear of the engine, in particular in the case of Diesel engines due to particulate matter (Diesel smoke). Yet even under such conditions, executions with Diesel engine exhaust gases still last several hours; see chapter 1.3.1. and Pattle *et al.* 1957.

I will now scrutinize and comment on each of the demanded modifications.

### *1. Adding slits and flaps*

The demand to have two slits of 10 cm × 1 cm added to the rear wall of the cargo box so that excess gas can escape means that at the time the memo was written no such slits existed and that the gas had no other way of escaping – or else the slits would have been superfluous. Hence the cargo boxes would have been sealed hermetically and the gas pressure would have built up inside until the doors were opened; many “witness testimonies” as well as the Becker document analyzed before confirm this explicitly. Nonetheless these boxes are said to have gassed almost 100,000 human beings. In my mind this is a radical impossibility.

Connecting an exhaust pipe to a closed cargo box would have resulted in an immediate and rapid increase in gas pressure, which would ineluctably have led to the cargo box buckling and eventually bursting (see chapter 1.3.2.). That the cargo box could have resisted the resulting high internal pressure is extremely unlikely, but even if that had been the case, then the engine would have died as soon as the counter pressure had reached a certain level.

Considering these facts, how could it have been possible to gas even a single person under the described circumstances? The reference to an “explosion at Kulmhof” does not yield any answer either, for first of all it says that it was a single case, and second it is said to have been caused not by a flawed design but due to an operating error.

If, however, openings are added to the cargo box, the situation changes instantly; the connecting hose can simply be attached to the exhaust pipe, and in this case the cargo box functions as a giant muffler, through which the exhaust gases flow.

The author of the memo specifies that the slits are to be equipped with flaps “in order to allow for self-regulation of any potential excess pressure.” Unless this is simply a case of clumsy wording, we are dealing with an error in reasoning here. Of course it is the slits which prevent an overpressure, not the flaps; quite to the contrary, the latter create a minute overpressure already due to their weight and also because they cover a certain part of the slits, depending on the degree to which they are open. Considering that the amount of gas produced by the engine is considerable, these flaps would indeed have to be constantly in

the open position during a hypothetical gassing operation to prevent excess pressures. So what were the flaps good for? The only technically plausible reason for adding such flaps is to prevent both the formation of excess pressure and a free exchange of air while *no* exhaust gases were piped into the cargo box. But why was that necessary, if the vans served no other purpose than gassing people? I will return to this point in chapter 2.2.6. when discussing the likely real purpose of these RSHA special vehicles. Anyway, the uselessness of these flaps for a hypothetical gassing van seems to have slipped the author's attention.

I should add here that in a later, probably authentic RSHA document of 23 June 1942 reference is made to the fact that the first 20 Saurer trucks delivered to the RSHA had "openings covered with sliders" in their back doors, which means that the cargo boxes of the real Saurer trucks *never sealed hermetically*, although such sliders could have been a major obstacle for excess gases to escape, depending on their design. The RSHA document mentioned requested the *replacement* of these sliders with slits of the same kind as described in the Just document (see point 7 of this document on p. 323), whereas the Just document gives the impression that the slits were not as replacement item but rather a new feature.

## 2. Shortening the cargo box

The two paragraphs dedicated to this demand seem to be the result of an abstract intellectual construct.

– First the author of the memo states that the Saurer truck cannot be loaded with 9 to 10 per m<sup>2</sup>, "because their off-road capability is highly reduced by this," "although no overloading occurs thereby."

1. Remark: If considering that the cargo boxes installed on the Saurer chassis had a surface area of (5.8 m × 2.3 m ≈)<sup>20</sup> 13.3 m<sup>2</sup>, then a loading density of nine to ten persons per m<sup>2</sup> would have resulted in a load between 120 and 133 persons.

First of all, this amount is at the upper range of what witnesses have claimed about these vehicles, whereas the most frequent claim is about 50 to 60 persons (see chapter 4.2.4).

Next, assuming an average weight of 60 kg per persons,<sup>48</sup> this density would also have resulted in a total load between seven and eight metric tons, which is two to three tons (40 to 60%) over the maximum load

<sup>48</sup> Usually an average weight of 75 kg is assumed for adults, but since the lower weight of children has to be considered, I have reduced this average weight to 60 kg.



capacity of the Saurer trucks of five tons.<sup>46</sup> Hence the statement “although no overloading occurs thereby” is clearly false.

Finally I may suggest that it is psychologically impossible to pack people that dense under the claimed circumstances without having their disciplined cooperation. Beating them up and threatening them, as the perpetrators are said to have done according to numerous court verdicts, would more likely have led to panic rather than cooperation. In this context Marais cited a newspaper report, according to which the Japanese traveling in Tokyo’s subways do not succeed in packing themselves more densely than just over seven people per m<sup>2</sup>, although they all cooperate and try hard (*Le Monde*, 20/21 January 1985).

Hence the claim that nine to ten people per m<sup>2</sup> could be and usually were loaded into these trucks is simply bogus.

2. Remark: The off-road capability of a vehicle depends for the most part on its design and not on its load. It is primarily ensured by the existence of several driven axles – the front axle among them – a reduction gear unit, and possibly a limited slip differential. (As to the reason of driving the truck off-road: from several court verdicts it emerges that the trucks are said to have been driven to off-road mass graves or tank ditches where the victims were allegedly buried.)

– The author of the memo categorically states next: “A reduction of the load area appears to be necessary.”

3. Remark: The way this sentence is phrased it implies that a reduction of the load area would compensate for the reduced off-road capability, which is very odd. But when continuing to read, it becomes apparent that the decrease in size is demanded for a different reason.

– Next the author of the letter claims that the impeded off-road capabilities could not be remedied by “reducing the number of units.”

4. Remark: Reducing the number of those locked up in the cargo box would indeed have solved the difficulty – if an excess load had been the reason to begin with. Yet such an approach is claimed unsuitable because...

– The author of the document claims to prove that a mere reduction of the number of people per load would increase the time needed for the killing, “since the empty spaces also must be filled with CO.”

5. Remark: Assuming a ceiling height of some two meters for the gas vans of an unknown make (e.g. Rüter *et al.* 1968ff., vol. XXI, p. 230) – otherwise the victims couldn't have stood inside the cargo box – the volume available for each square meter of floor would have been 2 m<sup>3</sup>. In case of the Saurer trucks with their cargo box height of merely 1.7 m, it would have been 1.7 m<sup>3</sup>. Assuming further that 9.5 people with an average volume of 60 liters each (≈60 kg) could indeed be crammed onto one square meter, they would occupy some 0.57 m<sup>3</sup>, which amounts to 28.5% of the total volume (2 m ceiling height) and 33.5% (1.7 m ceiling height) respectively, hence some 71.5% and 66.5% had to be filled with gas even then. Even when reducing the density drastically to five persons per m<sup>2</sup> – a density more likely to be achievable with non-cooperative victims – then the percentage to be filled with gas would have risen only from 71.5% to 85% (2 m; +19%) and from 66.5% to 82% (1.7 m; +23%), respectively. Hence, even reducing the density of the victims drastically would have increased this free volume only marginally. Considering that flushing the entire cargo box once



**Illustration 2:** A heavy goods Saurer Diesel truck, series C, as produced between the mid 1930s and the 1950s.<sup>49</sup>

<sup>49</sup> <http://de.wikipedia.org/w/index.php?title=Datei:Saurer1038.jpg&filetimestamp=20041127172501>.

with exhaust gases would have taken only a few minutes (see chapter 1.3.2.), an extension of this time by some 20% isn't exactly something any mass murderer would be worried about. This proves that the author's worries were misplaced at best.

– The author of the document continues his train of thought and claims that the shortening of the cargo box (that is, the gassing box) by one meter would allow “a substantially shorter operation time” due to the reduction of free space while keeping the load.

5. Remark: Reducing the Saurer cargo box length from 5.8 m by one meter reduces its length by about 17%, so the loading capacity goes down accordingly. If assuming a box width of 2.3 meters and a loading density of ten persons per square meter, then the load would go down by some 22 persons from 133 to 111. The corresponding calculations for free space would look similar as those above. Which way ever one looks at it, there is no reason to assume that such a change would lead to “a substantially shorter operation time.” Apart: if the gassing device had been constructed properly and if the amount of gas flowing through was sufficient – which could have been the case only and exclusively if an opening existed – then the existence of free space had basically no influence on the speed with which suffocation occurs. It can therefore be ascertained that the “Saurer special vehicles,” if maintaining their off-road capabilities had required it (which is not evident at all), could have been loaded with considerably less than nine to ten persons per square meter without noticeably increasing the required gassing time. Hence there was no apparent reason for the demanded shortening of the cargo box.

– As if he had second thoughts, the author of the memo points out that a shortening of the cargo box “would result in a disadvantageous weight displacement” and that “an overloading of the front axle occurs.”

6. Remark: This is not true. Although the shortening of the rear part does indeed lead to a shift of the center of mass of the – presumably evenly distributed – load toward the front, this does not result in a higher load on the front axle, because the total weight has also been reduced (this is, after all, the initial hypothesis). Provided, of course, that the vehicle isn't overloaded in general, which would have been the case with a loading density of nine to ten persons per m<sup>2</sup>, but that would have primarily affect the rear axle bearing the main load, not the front axle.

– The author of the document is nevertheless convinced that such an overloading would occur, but he discovers a palliative remedy: “the load striving towards the back door always predominantly lies there”!

7. Remark: Can one seriously believe that nine to ten persons crammed onto each square meter can compact themselves even more and thus shift their collective center of mass? And apart from that: How could the victims strive toward any location during a mobile gassing operation, that is, while the car rolled off-road, jostling the load back and forth, left and right? If there ever had been a danger of overloading an axle, it would have been during off-road transit. If this sentence proves anything, then the fact that nowhere near ten persons per square meter were ever crammed into that cargo box, as moving collectively in one direction and coming to lie predominantly at a certain part of the cargo box presupposes that it cannot have been cram-packed with people.

In brief: a slight shortening of the cargo box could not have caused an overloading of the front axle, and even if that had been the case, then this would most certainly not have been compensated by the victims striving toward the rear of the truck. It should also be noted that only a massive overloading can lead to premature wear or even to a broken axle, as the load-bearing capacities of axles is in general generously designed.

### 3. Relocating the exhaust gas filler pipe upwards

The author of the memo writes:

*“The connecting hoses between the exhaust pipe and the vehicle frequently rust through, because they are corroded on the inside by accruing fluids.”*

In chapter 2.2.3.5. I have already discussed the improbability that exhaust hoses rust through within a few months. It would have taken years before such metal hoses had rusted through.

The subsequently stated request to change the exhaust gas entry opening implies that as of then the gas had been piped into the cargo box through just one opening in the cargo box floor.

Udo Walendy claims that by connecting the hoses conducting the gases to the floor of the cargo box, it had to be assumed right from the start that fluids would enter into it, be it during a gassing procedure or while cleaning the cargo box (Walendy 1979, p. 30). I don’t agree with this, as any engineer would have rightly assumed that any liquid which might have seeped into the hose would have been driven out and/or

dried by the hot exhaust gases, hence this issue of fluids would not have been considered to be a problem during a gassing. The hole could have been blocked by any other object, though, which might have been accidentally or intentionally dropped into the hole by a victim. Such a blocking of the pipe would have caused the motor to die right away, which would have ended the gassing operation right there. And if such a blocking of the pipe could occur accidentally, how could one have prevented the victims from deliberately blocking this inlet hole with an object? How can one gas 97,000 people under such circumstances?

I may also point out that the reference to the frequent corrosive destruction of the connecting hoses contradicts the initial claim of the letter that so far no “defects in the vehicles” have become “apparent.”

#### *4. Adding a drain in the floor and slanting the floor toward it*

While adding a drainage opening in the middle of the floor does not pose any difficulties, it is not at all easy to design the floor in a way that it has an incline toward that opening in order “that all fluids flow toward the center immediately.” Since the floor of utility vehicles is generally even, this requested change would either have required the construction of a special concave floor or a second floor of this shape covering the original floor. Both solutions would have required comprehensive efforts.

Regarding the subsequent sentence that such a floor would prevent “that fluids enter into the pipes” (this must refer to the pipes for the introduction of gas), it seems the author of that letter has forgotten that in the previous paragraph he had requested to move that introduction pipe away from the floor, which, if realized, would have completely solved the problem of cleaning the cargo box – unless he assumed right away that his suggestion of moving the gas inlet had hardly any chance of being accepted. But if his superiors would not implement such a small change as moving the exhaust opening away from the floor, how could he seriously assume that they would go through the trouble of installing a concave floor?

#### *5. and 6. Removing observation window and better protected lamps*

Removing the observation window would indeed facilitate the production of the vehicles, even though their installation does not pose a technical problem, as Udo Walendy has pointed out.

Demanding a better protection of the lamps makes sense, although it is not conceivable why the victims should have had an interest in damaging the light, if they panicked “due to the eerie nature of darkness.” If it was dark, how did they find the lamp in the first place? If the lamp was on, it wasn’t dark, was it?

It is more likely that the victims would have tried to damage the observation window, which, if not made of bullet-proof glass, could have been destroyed with a mere stone that a victim could have grabbed just before entering the truck. Hence, a suggestion of *either* securing *or* removing the observation window completely should be expected here.

Although it is conceivable that the victims would have had the tendency to “strive toward the door” after the doors had been closed, the author’s explanation is nonsense that this movement toward the door was due to “the load” striving “towards the light” when the ceiling lamp had been turned on. Since the doors were allegedly “hermetically sealed,” no light could have entered from it. Apart, the only natural light entering the cargo box after the doors had been closed would have come through the observation window. Hence if they did indeed strive toward the light, the victims would have moved toward the window, particularly after the commencement of the gassing, and if only in an attempt to break the glass for the sake of getting fresh air. If they moved toward the door, then only because they *knew* it was a door and hoped to get out despite it being locked. Such a reaction would indeed be natural and could actually become so intense in situations where crowds fear their demise that they can break open even the most sturdy, locked doors (while squeezing and trampling to death some unlucky fellows, for sure).

### 7. *Adding a retractable grate*

Such a device is seemingly easy to design, but its installation and operation would have caused great difficulties, because this grate needed to be able to carry a heavy load, which would have caused leverage forces when pulling out the grate.

In summary, this document makes a similar impression as the previous one: Its technical improbabilities are no less frequent than those of the former document. Especially the first requested change requires by its nature that the vehicles could not have functioned in their original design; this leads us to radically doubt the authenticity of this letter. As

we shall see later, Ingrid Weckert shares out point of view. I will next summarize some of her observations.

#### 2.2.4.3. Ingrid Weckert on the Just Document

Ingrid Weckert's original German analysis of this document (1985, pp. 23-28) was published in a somewhat revised version in English (2003). Instead of quoting it in length, I will only give the highlights of her analysis here and refer the reader to her full text for a more thorough reading.

The contents of the German Federal Archives file R 58/871, which reflect a coherent sequence of events, are as follows:

April 1942: The RSHA considers equipping its special vehicles with a device to accelerate their unloading.

23 and 24 April 1942: Representatives of the RSHA and the Gaubschat Company meet to discuss three possible solutions, of which only the third, the manufacture of a retractable grate, is taken into consideration.

27 April 1942: The RSHA has a note prepared with a precise suggestion for the construction of a retractable grate.

(30 April 1942: In a letter to the Gaubschat Company the RSHA requests the agreed-upon design changes according to the above-mentioned note. This document is not part of the file, but is mentioned in the next document, the response of the Gaubschat Company.)

14 May 1942: In a letter to the RSHA the Gaubschat Company declares that it cannot implement the changes requested in the RSHA letter of 30 April 1942 due to lack of personnel.

23 June 1942: Internal writing by Pradel. As its first point it discusses the impossibility to have the outstanding vans produced by a Czech company, since secrecy could not be guaranteed. Point two of the memo is a draft for a letter by the RSHA to the Gaubschat Company, in which, with reference to a meeting between RSHA officials and Gaubschat employees of 16 June 1942, the originally requested major changes of the vehicle design are abandoned in exchange for seven minor modifications.

18 September 1942: The Gaubschat Company informs the RSHA in its response that the requested design changes will be implemented, but initially only for one vehicle.

24 September 1942: The Gaubschat Company informs the RSHA that it will manufacture the remaining nine vans.

All these documents bear the same file reference number of the RSHA: "II D 3 a (9) Nr. 668/42." Hence these documents were not classified. These documents are reproduced in Appendix 4 with translations and comments, where due.

There are two more documents in this file R 58/871, which have no connection to these documents:

- Letter of the RSHA of 26 March 1942 to the Institute for Police Technology (*Institut für Kriminaltechnik*) regarding a special van for the Mauthausen camp.
- Note of the RSHA of 5 June 1942 (the Just document).

The first one in the list was probably accidentally filed in that folder by mistake (or with malicious intent), whereas the last one is the Just document, which bears a different reference number: "II D 3 a (9) Nr. 214/42 g. Rs.," where "g. Rs." indicates that the document is classified as "secret state matter."

The unsuspecting documents of file R 58/871 form a logical sequence of correspondence between the RSHA and Gaubschat regarding requested modifications to certain special vehicles, whose purpose is the transport of some goods, without specifying the type of goods. Nothing in them indicates that they deal with anything criminal. These documents all have the same reference number, are not marked as secret, have each sheet numbered (not the pages), and follow one another chronologically. They deal with changes to be made exclusively to future, that is, newly constructed "*Sonderfahrzeuge*," the common German term for special vehicles.

From the contents of these letters it can be derived with certainty that those vans could *not* have been used for transporting living human beings.

First of all, the height of the vans after their suggested conversion would only have been 162.5 cm at most (5'4"),<sup>50</sup> which is inadequate for transporting standing people. Next, it is stated that a minimum free clearance between a potentially tipable floor and the ceiling would have to have been a mere meter (3'4"), because otherwise the load would be crushed. Hence this load, whatever it was, could not have been people, some if not most of whom must have been expected to stand upright even after their presumed death, if the van had been cram-packed with people.

---

<sup>50</sup> It might even have been lower, see my consideration on p. 86.



**Table 1:** Comparison of the Documents in File R 58/871

FEATURE	CORRESPONDENCE	JUST LETTER
<i>Sender</i>	given*	not given
<i>Reference</i>	II D 3 a (9) Nr. 668/42-121	II D 3 a (9) Nr. 214/42 g.Rs.
<i>Topic</i>	changes to new vehicles	changes to old and new vehicles
<i>Term</i>	<i>Sonderfahrzeuge</i>	<i>Spezialwagen</i>
<i>Secrecy</i>	none	top secret
<i>Pagination</i>	per sheet	per page

\* "Reichssicherheitshauptamt" on 27 April, "Der Chef der Sicherheitspolizei und des SD" on the others.

One suggested change requested that an "angled gridwork" of 30 to 40 cm (approximately 12" to 16") in height was to be added to the end of a prospective floor grate in order "that the load does not fall over the last grate towards the back of the driver's cabin." Living, standing people, however, could never be prevented from falling over such a low trellis.

Weckert therefore concludes that the special vehicles discussed in those letters cannot be the same as those discussed in the Just document.

In contrast to this stands the Just document, which has a different reference number, hence does evidently *not* belong to this line of correspondence. It is also the only one with all its pages numbered and rubber-stamped as "Top Secret." Plus, it talks about changes to future *and* old "*Spezialwagen*" (special wagons), a term never used in the other documents. A summary of the discrepancies between this document and the others can be gleaned from Table 1.

#### 2.2.4.4. The Just Document and the Letter of 23 June 1942

In and of itself, the Just document contains, as we have seen, numerous anomalies, which raise doubts about its authenticity. When comparing it with the letter of 23 June 1942, one of the other documents in the file R 58/871, the authenticity of which cannot be doubted due to its internal logic and chronological consistency, Ingrid Weckert was able to show that the Just document is actually a rewritten plagiarism of the RSHA letter of 23 June 1942.

While both documents have seven points, the RSHA letter's content is always innocuous, whereas the Just letter gears them toward homicide (see Weckert's tabular juxtaposition in 2003, pp. 234, reproduced here in on pp. 328f.). Since there is no direct relation between the seven points made in both letters, this alone may not be a strong argument to

claim a forgery. The most obvious proof for a forgery, however, is the fact that the Just letter, dated June 5, is actually referring in its point 2 to a consultation between the RSHA and Gaubschat, which the letter of 23 June 1942 shows to have taken place only 11 days later: on 16 June 1942!

It is difficult to imagine that such anomalies are a pure coincidence and that the pre-dating was *not* a deliberate act.

#### 2.2.4.5. Comparison of the Three Versions of the Just Document

Interestingly enough, although the Just document claims to be the “onliest” copy, it actually exists in at least three different “onliest original” forms. Two of them are easily accessible, as they have been reproduced in widely available books, whereas the third is a photocopy of DIN A4 size (21 cm × 29.7 cm) in the file R 58/871 of the German Federal Archives. The differences between those three versions are summarized here and are also given in more detail in Table 2:<sup>51</sup>

- The first “original” is in the German Federal Archives. We take it as the standard here.
- The second “original” was used by Kogon *et al.* (1983, pp. 333-337). Here several text underlining have been added, plus on the last page vertical marks at the edge, the word “*ja*” (yes) next to them, as well as an initial and date claimed to stem from Rauff (“*R<sub>10/6</sub>*”) are missing.

**Table 2:** Differences between three version of the Just letter

Page	German Federal Archives	<i>NS-Massentötungen...</i>	<i>NS-Prozesse</i>
1	no underlinings	date line underlined; three lines from “ <i>Seit</i> ” to “ <i>aufreten</i> ” underlined	no underlinings
3	no underlinings	three lines from “ <i>Es wurde</i> ” to “ <i>starkes</i> ” are underlined	no underlinings
4	no underlinings	line from “ <i>Drängen</i> ” to “ <i>erfolgte</i> ” is underlined	no underlinings
5	no underlinings	the line “ <i>SS-Obersturmbannführer Rauff</i> ” is underlined	no underlinings
5	right margin marking with word “ <i>ja</i> ” (yes) plus initial with date present: “ <i>R<sub>10/6</sub></i> ”	no marking, no word, no initial or date	no marking, no word, no initial or date

<sup>51</sup> For the archival version see Appendix 4 (p. 318). For the two version published in books see Appendix 5, starting on p. 334.

- A third “original” was published by Ruckerl.<sup>52</sup> It is almost identical with the copy in the German Federal Archives, except that here, too, the vertical marks, the “ja” and the initial with date are missing on the last page.

Weckert also pointed out that the initial on the last page of the version in the German Federal Archives, which is claimed to be Rauff’s, is very similar to that on 501-PS, but decisively different to Rauff’s signature and initial on other documents. Be that as it may, since anyone could have made this initial, it doesn’t prove much.

These differences do not pertain to the machine-written text, which seems to be identical in all three versions. One may therefore assume that they all derived from the same document.

Since the Just letter exists in three versions, even though it claims to be the “onliest” copy, it must be assumed that the “original” was changed by later additions and/or deletions. How did the original look? Was it the version reproduced in *NS-Prozesse*, which shows the least changes? Or the one in the German Federal Archives, which bears an initial and a date – which is interpreted to stand for the recipient (Rauff) and the date of reception (June 10)? Or the one reproduced in *Nationalsozialistische Massentötungen...*, which contains numerous underlinings?

Logic makes us assume that the original ought to be in the Federal Archives, if the document is authentic. In that case the authors of both books mentioned have reproduced this version, but purged the margin lines and the initial plus date at the end. While the word “ja” could simply have been clipped off during reproduction for the book, the lines at the margin and the initial with date run into the text area and thus had to be blotted out manually (in 1971 there was no Photoshop around yet). But why would they have deleted Rauff’s(?) initial and the date on the last page, if they support their thesis, as Ingrid Weckert rightly pointed out? And even though it is conceivable that some investigator or prosecutor using a copy of this document has underlined the most incriminating sentences of this document – for this is what is underlined in the Kogon version – why would he also have underlined the date line on page one and Rauff’s name and rank on the last page?

It is impossible to come to coherent conclusions from these conjectures, so the questions posed here remain unanswered.

---

<sup>52</sup> Ruckerl 1971, pp. 209-213; it ought to be pointed out that Ruckerl is also among the editors of the book *Nazi Mass Murder* (1993).

### 2.2.5. Comparison of the Becker and Just Document

Although both the Becker document of 16 May 1942 and the Just document of 5 June 1942 appertain to the same kind of vehicles, which are claimed to have been prototypes deployed around the same time, there are considerable differences in both documents. In fact, what they state about the alleged gas vans is at times outright contradictory, giving the impression that both authors were *not* writing about the same objects. A summary of the main discrepancies is given in Table 3. They clearly show that only one of these documents can be genuine, if any.

Regarding the layout one difference is conspicuous: While the Just document was made in flawless machine writing and contains no typos or corrections (see Appendix 4), the version B of the Becker document (single-spaced) is riddled with all sorts of typos and handwritten corrections (see Appendix 2); versions A, C, and D (double-spaced) seems to have been written with more care, but as far as can be judged from the extant reproductions – photographs – this version still does not reach the meticulousness with which the Just document was produced.

**Table 3:** Juxtaposition of the Becker and the Just documents

BECKER DOCUMENT	JUST DOCUMENT
Reference to numerous flaws. No reference to openings for gas release.	Reports 97,000 executions, “without any defects in the vehicles becoming apparent.”
In spite of the numerous flaws no changes to the vehicles are requested.	Although no defects had occurred, seven changes are requested (internal contradiction).
Reference to difficulties of moving the vans: during moist and rainy weather the vans are inoperable.	Reference to a highly reduced off-road capability while fully loaded, resulting in the need to reduce the load.
Emphasizes the importance of keeping the cargo box hermetically sealed; it is even considered to send the vans to Berlin for this purpose.	The first of the requested changes concerns two slits of 1 cm × 10 cm to avoid high internal pressure.
The vans were camouflaged without attaining a permanent deception about their purpose.	No attempts at camouflage were implemented.
Thoroughly addresses the danger of the operating personnel inhaling the gases – although the cargo box is hermetically sealed.	No reference to such a danger.
The author wants to ascertain that the victims do not die of suffocation but die a humane death through falling asleep.	No efforts are made to induce a painless death of the victims.

In summary: The Becker documents, versions A, C, and D, give a better impression of authenticity than the three versions of the Just document, which are based on one single machine-written, impeccable text that had obviously been tailored after the war to achieve a certain goal. It goes without saying that this does not imply that the authenticity of the various versions of the Becker document is historically beyond reproach!

### 2.2.6. The Real Purpose of the RSHA Special Vehicles

The information contained in the file R 58/871 about the cargo boxes of the RSHA special vehicles do not reveal anything about the nature of the intended load. All one can ascertain is that the material wasn't particularly fragile, since the unloading was to occur "fast" and "automatically"; for this reason it was considered making "the entire cargo box or a second floor tiltable."

Here is Pierre Marais' hypothesis about the nature of the intended load:

*The RSHA special vehicles with the described cargo box allowing a fast automatic unloading were meant for the transportation of corpses.*

The following points support Marais' hypothesis:

- 1) The organization responsible for the conversion of these vans was responsible for security and police issues, which indicates that third persons were meant to remain unaware of the load. The load could have been corpses – of executions, "natural" deaths, or war casualties – which had to be transported *en masse* to crematoria, open air incineration places, or mass graves.
- 2) The load was obviously not (or no longer) fragile or delicate.
- 3) The weight of the load, 4,500 kg, corresponds to some 60 to 75 corpses, which would have amounted to an average of six corpses per square meter, which sounds plausible.
- 4) The requested hygienic measures:
  - a) In order to permit a thorough and effortless cleaning, the inside of the van had to be covered with smooth sheet metal. The protruding parts of the back wall had to be beveled with sheet iron. A large opening had to be included in the cargo box's floor.
  - b) In order to limit foul smells from exiting the van, the cargo box was to be sealed, though obviously neither airtight nor pressure-resistant. Openings in the upper part of the side walls served to

allow any excess pressure building up inside to escape while preventing a free exchange of air.

In addition to Marais' supportive points, I may add my own:

- 5) The technician at the Gaubschat Company who supervised the design and construction of the cargo boxes ordered by the RSHA, a certain M. Bauer, testified in 1961 that the RSHA employees Pradel and Wentritt had told him during a visit that they would need the vehicles in order to transport corpses caused by typhus.<sup>53</sup> Since Bauer had to know what the load would be for which he had to build a cargo box, it surely didn't matter what the cause for the victims' death was. Hence I consider it likely that Pradel and Wentritt told Bauer the truth about the cargo, but not necessarily about the reason for their existence.
- 6) In the original version of his Nuremberg testimony, Otto Ohlendorf consistently used the term "*Totenwagen*" = corpse vehicle (or wagon for the dead). The "*Toten*" was later struck out and replaced by "*Gas*" (IMT, vol. 31, p. 41; see chapter 3.5.3.). It may be assumed that he did this either due to habit, as he used to call these vehicles that way, or in order to somehow slip a message into his affidavit for future readers.
- 7) No matter what the corpses' origin was, the German authorities must have had an interest in reducing the number of witnesses to a minimum, as witnesses during wartime tend to spread all kinds of founded and unfounded rumors. A speedy unloading mechanism reducing the need for manual labor served that purpose.

These considerations are valid independent of the type of speedy unloading mechanism requested and eventually realized.

The main objection against this hypothesis could be that the height of the angled gridwork of 30 to 40 cm is insufficient in order to ensure "that the load does not fall over the last grate towards the back of the driver's cabin." Although it is true that six corpses deposited per square meter would form a higher pile, this is only the average density of the load. The load usually is higher in the middle as well as particularly at the rear of the cargo box – which would also have been conducive to a speedy unloading – so that one may assume that only up to two corpses would have been lying on top of each other at the front end of the cargo box. In that case the gridwork would have served its main purpose –

---

<sup>53</sup> Testimony of M. Bauer, Gaubschat engineer, 21 March 1961, prosecution Hannover, ref. 2 Js 299/60; quoted acc. to Beer 1987, p. 410.

quite independent of the unloading mechanism eventually chosen – as well as its auxiliary purpose in case of an unloading with an extractable grid: facilitating the extraction of the load.

The low height of the gridwork designed to prevent that the load doesn't fall between the end of the floor grid and the cargo box's front wall isn't just an objection to my hypothesis. It is an even more grave argument against the orthodox hypothesis according to which these RSHA special vehicles are identical with the infamous "gas vans" used to kill numerous living, that is to say: *standing* people crammed together in the cargo box with exhaust gases. It is obvious that, after the gassing operation, many of the tightly stacked corpses at the front part of the cargo box would have fallen over this small gridwork during unloading, thus preventing them from being automatically removed, no matter what the unloading mechanism would have been. To prevent standing people from toppling over a fence-like structure requires a height *at least* three times higher than requested (one meter and more).

Another argument against the "gas van" hypothesis is the low height of the cargo box of only 1.70 m (memo of 27 April 1942). After installation of the retractable floor grid this height was reduced by 7.5 cm to a mere 162.5 cm (*ibid.* as well as order of 30 April 1942). Another even more drastic reduction of the free height occurred due to the new requested version with the floor grid rolling on U-shape rails (letter of 23 June, #3), which could only be done by lifting the floor grid even higher (see Marais' drawing on p. 311).

Since the floor grid had to be installed on top of the wheel housings – which usually protrude much higher than just 7.5 cm from a cargo box floor – and since the lateral U-shaped guide rail would have rested on the mentioned extension of the wheel housings, much more than the claimed 7.5 cm would have been lost. As a matter of fact, the floor grid itself would already have had a height of some 5 cm, if it was to bear the weight of up to ten panicking people per square meter. I assume therefore that the height was reduced by at least 30 to 50 cm, which would have reduced the available height above the grid to some 1.20 to 1.40 m. Quite apart from the reduction of the maximum loading capacity affected by this, it goes without saying that no grown-up individual would have been able to stand upright in that cargo box: The "passengers" would have had to bend over or even crawl into the van.

Another argument against the gas van hypothesis is the vehicle model chosen. During the war, the German Wehrmacht obtained almost

100,000 medium-size trucks (3 tons) of the type Opel Blitz, which had a 3,600 cm<sup>3</sup> gasoline engine.<sup>54</sup> Equipped with an appropriate cargo box, this vehicle could have served as a “gas van.” Yet the RSHA instead decided to buy Saurer heavy goods trucks, which had Diesel engines and were therefore only capable of slowly torturing the intended victims to death. Considering that the RSHA even wanted the cargo box to be shortened (see letter of 23 June 1942 in Appendix 4, pp. 323ff.), why then buy a long unsuited truck to begin with, when shorter, suitable trucks are to be had at every street corner and probably for much lower prices? It must therefore be assumed that the purpose of these vehicles was not to kill with exhaust gases.

### 2.2.7. The Turner Letter, 11 April 1942

This letter claims to have been written on 11 April 1942 by SS-*Gruppenführer* (Major General) Dr. Harald Turner, who at that time was the head of the German military administration in Serbia. It was directed to General Karl Wolff, who was chief of Himmler’s personal staff. During his own trial in 1964 in Munich Wolff insisted that he had no knowledge of what was happening to the Jews – as Himmler’s adjutant (Giese 1964). It is not known whether Wolff ever received this letter.

Harald Turner had a PhD in law, hence could be considered well-educated. In spite of this, his letter is riddled with spelling errors, butchered German language, and nonsensical content, which I will discuss subsequently. The author of the letter tried to emulate the rune-shaped SS type, which was included on official typewriters of the era, by superimposing a double slashes on a dash and adding another double slash a three-quarter line lower: *///* (although I don’t know how this could be accomplished with such accuracy for all 4 cases, as a subscript-like half-line lift wouldn’t have been enough).

As the head of Serbia’s wartime military administration, Turner or his secretary must have had access to a proper typewriter sporting the runic SS key. But even if he had no such typewriter, using a simple SS in replacement was common and acceptable. I have never seen such a forced SS rune on an official letter of that era before, and neither has anyone else I’ve asked. It is also awkward that Turner’s personal letter-

---

<sup>54</sup> See [www.cokebottle-design.de/dokuwiki/doku.php?id=typenspezifisches:opel\\_blitz\\_3\\_to\\_3\\_6-36](http://www.cokebottle-design.de/dokuwiki/doku.php?id=typenspezifisches:opel_blitz_3_to_3_6-36).



head, on which this letter gives the impression to have been typed, did not contain his SS rank, so that the writer added it using his inventive *ff* improvisation. David Irving has remarked that the original of this letter, which is kept in the Berlin Document Center biographical file on Turner, does not have the German standard paper format (DIN A4, 210 mm × 297 mm) but instead U.S. letter format, a paper size which during the war was not available in Europe.<sup>55</sup>

A reproduction of the document (taken from Friedlander/Milton 1992, part 2, pp. 284-286) and its English translation can be found in Appendix 6.

### 2.2.7.1. Problematic Content

- The first four paragraphs describe an event with many words without even once stating what this is all about. What makes the author think that the recipient knew what he was writing about? As far as I could verify, there is no historical event – some decision in favor of Turner and against some ominous “Wehrmacht” interests – which would warrant such sentences. As a matter of fact, there had only been a decision *against* Turner, whose attempt to gain Serbian support for his occupational policies led to deteriorating relations between him and his SS men, not the Wehrmacht. As a result of SS claims that Turner was too soft on the Serbs, the anti-Serbian hardliner August Meyzner was appointed as head of the local SS units in early 1942, which seriously undermined Turner’s position (Browning 1995, pp. 134-136; Manoschek 1995, p. 170).
- The letter insinuates that this ominous foiled Wehrmacht intrigue was directed not only against Himmler (whose title was *Reichsführer SS*, not *SS-Führer*) and the SS, but also the “corps of civil servants” (*Beamtenschaft*), which means all of Germany’s civil servants. Such a Wehrmacht intrigue potentially affecting millions of German civil servants sounds far-fetched to the point of being outrageous, and I could not find anything in the literature confirming this.
- The attachment mentioned in the letter is unknown. The letter insinuates that it might have dealt with some pressing issues about Jews in Serbia. At any rate, the writer takes this attached letter as a reason to jump right into the middle of a completely different topic.

---

<sup>55</sup> <http://www.fpp.co.uk/Legal/Penguin/Reply/3.html> and personal correspondence.

- After having dealt with the clearing out of “the camp” (this refers to the Semlin camp near Belgrade), the author suddenly changes tack, as he is now worried about the attitude of “Jewish officers” held as PoW, if they find out about that clearing. The author speaks again of “the camp” in singular, although there were many PoW camps in Germany and the German occupied territories. It is also inconceivable why those (relatively few) Jewish officers could have “easily” caused “complications.” And even if so, who would have cared, since Jews are said to have been expendable anyhow?
- “repercussions on our prisoners in Canada”: even though some German soldiers were held in Canadian PoW camps, the vast majority of German PoW camps in early 1942 were located in Britain and the U.S. In addition, if the Germans had to worry about any of their PoW in Allied hands, it would have been primarily about those in Soviet hands. The Canadians were the smallest players in that game. It is therefore beyond comprehension why Turner should have mentioned them. Unless, of course, the author of this letter was Canadian.

#### 2.2.7.2. Problematic Language

- “*möchte ich nicht verfehlen*” – probably literal translation from English “I don’t want to fail”; correct German would be: “*möchte ich nicht versäumen.*”
- “*meinen [...] Dank [...] zu übermitteln*” – correct German: “*meinen Dank auszusprechen*”; “*übermitteln*” means to convey thanks from a third person.
- “I can also again today, the more so since you know me well enough, only once more repeat” – a very circuitous way of saying nothing.
- “*Ich möchte nicht erinnern*” – English “I don’t want to remind”; incomplete phrase; correct German: “*Ich möchte ihn nicht daran erinnern*” or “*Ich möchte dies nicht anmahnen.*” The sentence basically makes the same statement twice: “I don’t want to remind, because [...] I don’t feel entitled to remind.”
- “*was allerdings weitergeführt worden ist*” – English: “which, however, was continued.” The “*allerdings*” (however) indicates a contradiction, but there is none here.
- “*Dann ist der Augenblick gekommen, in dem die [...] jüdischen Offiziere [...] hinter die nicht mehr vorhandenen Angehörigen kommen*”

- English: “Then the moment has come in which the Jewish officers [...] get behind the no longer existing relatives”; the German expression “*dahinter kommen*” (to find out about, to get to the bottom of) cannot be used with a mere “*hinter*,” in addition the entire sentence structure is wrong; correct is: “*Dann ist der Augenblick gekommen, in dem die [...] jüdischen Offiziere [...] dahinterkommen, daß die Angehörigen nicht mehr vorhanden sind.*” In the way used here this expression has a spatial meaning: to get behind something or somebody.
- “*das dürfte immerhin leicht zu Komplikationen führen*” – English: “that could after all easily lead to complications”; the “after all” here makes neither sense in German nor in English.
  - “*Werden nun die Betreffenden entlassen [...] nicht allzu lange*” – English: “When those affected [Jewish officers] are being released, they would in the moment of arrival have their final freedom, but like their racial comrades not for very long”: What is “in the moment of arrival” supposed to mean? The arrival moment of their freedom? If so, then this translates to: when freed, they are free at the moment when they are free, but not for long...

Considering the bad usage of the German language, the question arises whether this was Turner’s normal style. Friedlander/Milton have reproduced two more of Turner’s letters.<sup>56</sup> Both letters exhibit a perfectly normal usage of the German language. Although Turner had at times the tendency to write complex phrases, they are grammatically correct, consistent, and make sense, quite in contrast to the letter at issue here.

### 2.2.7.3. Spelling and Punctuation

Most German words requiring an “ß” are misspelled with an “ss” (wrong: *dass, weiss, erschiessen, Grüssen*), although a few are spelled properly. Commas are set erratically, and spaces between words and periods, commas, hyphens, and quotation marks are inconsistent. “Canada” is spelled the English way, not as the German “Kanada.”

The other two letters mentioned above do not show these erratic patterns. The first one (to Richard Hildebrandt from 17 October 1941) was apparently typed on a machine not possessing any “ß,” whereas the second one (a duplicate of a letter to Himmler from 1 March 1942, typed

<sup>56</sup> 1992, part 1, pp. 356-362 (NO-5810); vol. 11/2, pp. 282f. (NO-3404); for references to numerous other Turner documents similar in style see Browning 2004, pp. 521f., notes 106, 117f., 132; Browning 1986.

by a secretary), consistently uses a double s instead of an “ß” for the word “daß” (“that” as conjunction) but otherwise uses the “ß” correctly. It also uses a proper rune-SS, which proves that such a machine was at Turner’s disposal at that time.

#### 2.2.7.4. Assessment

Orthodox historians consider this document as a vital link to “reveal” that the term “delousing” was in fact used as a “code word” for homicidal gassings.<sup>57</sup> It is based on the following sentence:

*“Already some months ago, I shot dead all the Jews I could get my hands on in this country, concentrated all the Jewish women and children in a camp and at once with the help of the SD acquired a ‘delousing van,’ which will have accomplished the definitive clearance of the camp in about 14 days to 4 weeks, which, however, was continued by Meyssner since his arrival and the turning over of these camp issues to him.”*

By “Jews” obviously only Jewish males are meant. In the fall of 1941 there has been quite some back and forth between various Germans officials regarding the fate of the Jewish prisoners held in the Semlin camp. Whereas it was decided to shoot the males as hostages in the escalating partisan warfare, German foreign minister Ribbentrop determined in a telegram on 2 October 1941 with respect to women, children, and the elderly:<sup>58</sup>

*“As soon as the technical means exist for the complete solution of the Jewish question, the Jews will be deported on the waterway [i.e., the Danube] to the reception camps in the east.”*

Orthodox historians see this as a mere ruse, though:

*“[...] the Nazis employed elaborate deception: not only were the victims told that they were being transferred to a different and better transit camp, but they were given fictitious ‘camp regulations’ which they supposedly needed to get acquainted with prior to arrival at their destination.”* (Byford 2010, p. 19; based on Browning 1985, p. 80; cf. also Browning 1983, pp. 75f.)

However, so far no document is known which would have changed this decision to deport the Jews. Unless such a document is found, we must therefore assume that “clearance” of the camp was *not* equivalent with mass murder but rather with deportation. After the Wannsee Con-

<sup>57</sup> See [www.holocaust-history.org/19420411-turner-wolff/](http://www.holocaust-history.org/19420411-turner-wolff/).

<sup>58</sup> NG-3354, reproduced in Kempner 1961, p. 293.

ference on 20 January 1942 had established the bureaucratic means to implement this “complete solution,” the road was prepared to deport these Jews.

In this context it is interesting to note that Browning reports about Turner’s intervention with Felix Benzler, at that time Plenipotentiary for Foreign Affairs in Belgrade, in order to prevent the execution of the last 1,500 male Jews as hostages by trying to have them deported instead (Browning 1978, p. 61; 2004, p. 343).

Hence, in real life Turner was relatively “soft” on the Serbs in general and on the Serbian Jews in particular and had no interest in having them executed. The letter analyzed here, however, gives the opposite impression.

None of the problematic issues raised above are ever even mentioned, let alone addressed, by orthodox historians.

Could the well-educated Dr. Turner have written such an imbecilic letter on U.S. stationery with its phantasmagorical content while at once toying around with his typewriter – or have his secretary do so – in order to compose some artistic rendering of the SS rune?

### 2.2.8. Activity Report by *Einsatzgruppe B*

An “Activity and situation report of *Einsatzgruppe B*” of 1 March 1942, covering the time from 16 to 28 February 1942<sup>59</sup> (cf. Gerlach 1997, p. 68), mentions in passing that this group had received two large “gas vans” (*Gaswagen*) while having already two small ones. According to Gerlach this document was discovered in the 1990s among the papers of the *Staatssicherheit*, which was Communist East Germany’s secret service until 1990. Needless to say, this isn’t exactly a trustworthy source.

I have reproduced pages 7 and 8 of this report in Appendix 7. The relevant passages read as follows:

*“The following gas vans which arrived in Smolensk on 23 February 42 have been distributed as follows:*

*EK 8: ¶truck Saurer Pol 71 462*

*EK 9: ¶truck Saurer Pol 71457¶ Both vehicles arrived with defects in Smolensk and were allocated to the Einsatzkommandos after the defects had been repaired. After the conclusion of the operation*

---

<sup>59</sup> Der Bundesbeauftragte für die Unterlagen des Staatssicherheitsdienstes der ehemaligen DDR, ZUV 9, vol. 31, p. 159.

*at the EK 8, the two smaller gas vans will be transferred to SK 7a and to SK 7b.*

*After deducting the lost vehicles, the current inventory is as follows:¶[...]*

*Staff: [...]¶19 cars 4 trucks 3 special vehicles [...]*

*EK 8:¶35 cars 3 trucks 1 ambulance 1 gas van*

*EK 9:¶36 cars (of which one radio site) 5 trucks 1 gas van¶[...]*

*In addition it is necessary during the advance to staff all heavy vehicles – like repair truck, bus, gas van and tank truck – with two drivers.”*

As far as I know, this is a unique occurrence of the term “*Gaswagen*” in a German wartime document. Here the reader needs to keep in mind that there exist literally thousands of documents by the *Einsatzgruppen* listing in cruel detail, among other things, when they executed whom and why. But gasings are not mentioned once, and gas vans only occur in this one document from the archives of a communist secret service infamous for their lies and forgeries.

The vehicles in question are specified in this document as Saurer trucks; hence they were equipped with Diesel engines, which are unsuitable for homicidal purposes. Furthermore, they were apparently not considered to be “special vehicles,” the term used for homicidal “gas vans” in the telegrams of 501-PS and the Just document, because “3 special vehicles” are listed separately for the staff’s motor pool. It seems likely that these trucks were part of the set equipped with the Gaubschat cargo boxes, which moreover, as we have seen, were not suited for transporting standing people, among other things due to their limited height (see chapter 2.2.6.).

It is possible that these trucks were equipped with wood gas generators. However, in this case the term “gas van” is unlikely to refer to them potentially having such a gas generator, as the report appears to list the vehicles not by fuel source but rather by general vehicle type. If the Saurer trucks had been normal trucks merely using wood gas as their fuel, I would expect them to be listed among the normal trucks.<sup>60</sup>

It is odd, though, that the “two smaller gas vans” mentioned in this document as currently belonging to EK 8 but to be reassigned later to

<sup>60</sup> Although a separation by fuel type may occur in documents. For instance, the activity reports of the Auschwitz motor pool sorted the collective kilometers driven by its vehicles by the type of fuel used: Diesel & gasoline, wood gas, and “propellant gas” (*Treibgas*), probably referring to natural gas: Rossiiskii Gosudarstvennii Vojennii Archiv (Russian national war archives), Moscow, ref. 502-1-181, p. 246; see Appendix 7.

SK 7a/b are not included *as such* in any of the lists of vehicles assigned to the various groups. It may therefore be inferred that they are part of EK 8's three trucks, but if that is so, this means that these "gas vans" were listed as normal trucks after all, not as "special vehicles."

Hence it is possible, but not imperative, that these vehicles were somehow special. Not having been suitable for homicidal purposes with their inferred design, there seem to be three options left: a) these vans were equipped with wood gas generators; b) they were disinfestation vans; c) the document's authenticity is questionable.

A fourth option would be that these vehicles were homicidal vans after all, but must have used some other setup than attested to by witnesses and the Gaubschat correspondence.

In this context it should be noted that, during a 1966 West-German trial, the Germans deployed at *Einsatzkommando* 8 claimed to have no knowledge at all about homicidal gas vans in their former unit (see chapter 3.7.4.4.), which is in stark contrast to most other such trials, where at least some of the German defendants and witnesses frequently confessed to their existence and use. Interestingly, in later West-German trials the gas vans of *Einsatzkommando* 8, which in 1966 had been unknown to the Germans alleged to have used them, became more and more established "facts," with the memories of those involved slowly "refreshing" (see chapters 3.7.4.9. and 3.7.4.11.). The more those Germans were interrogated and had to testify or stand trial, the more their "knowledge" seems to have grown.

### 2.2.9. Remarks about Document NO-365

I haven't dealt with the Nuremberg document NO-365 yet, which is occasionally mentioned in connection with gas vans. This document is said to have been compiled by Dr. Erhard Wetzel of the German Imperial Office for the Occupied Eastern Territories. It is dated 25 October 1941 and directed to the Reich Commissar for the Eastern Territories, Heinrich Lohse in Riga. The letter mentions the names [Adolf] Eichmann, [Viktor] Brack, and [Helmut] Kallmeyer. Although gas vans are not mentioned in it, it refers to "gassing apparatus" (*Vergasungsapparate*) without giving any details. On occasion it is claimed that an illegible signature can be found at the end of this letter, but this is incorrect, as this letter (or this draft) isn't signed at all, hence it is unlikely that it was ever sent. The allegedly incriminating passage reads as follows (NMT, vol. 1, p. 870):

*“Referring to my letter of 10/18/1941, you are informed that Oberdienstleiter Brack of the Chancellery of the Fuehrer has declared himself ready to collaborate in the manufacture of the necessary shelters, as well as the gassing apparatus. At the present time the apparatus in question are not on hand in the Reich in sufficient number; they will first have to be manufactured. Since in Brack’s opinion the manufacture of the apparatus in the Reich will cause more difficulty than if manufactured on the spot, Brack deems it most expedient to send his people directly to Riga, especially his chemist Dr. Kallmeyer, who will have everything further done there. Oberdienstleiter Brack points out that the process in question is not without danger, so that special protective measures are necessary. Under these circumstances I beg you to turn to Oberdienstleiter Brack, in the Chancellery of the Fuehrer, through your Higher SS and Police Leader and to request the dispatch of the chemist Dr. Kallmeyer as well as of further aides. I draw attention to the fact that Sturmbannfuehrer Eichmann, the referent for Jewish questions in the RSHA, is in agreement with this process. On information from Sturmbannfuehrer Eichmann, camps for Jews to be set up in Riga and Minsk to which Jews from the old Reich territory may possibly be sent. At the present time, Jews being deported from the old Reich are to be sent to Litzmannstadt [Łódź], but also to other camps, to be later used as labor in the East so far as they are able to work.”*

Hence, the author simultaneously talks about the erection of shelters for Jews and of the installation “gassing apparatus.” These gassing devices are said to be manufactured in the Reich, yet not in sufficient numbers that some could be sent to Riga. Hence some ought to be constructed right where they are needed. Could these devices have been homicidal gas chambers? I opine that for the following reasons they could not:

a) No one has ever claimed that homicidal gas chambers were “apparatuses” which were produced centrally somewhere in the Reich and could be shipped to certain locations. All alleged homicidal gas chambers are said to have been erected locally in an *ad hoc* fashion.

b) No one has ever claimed that homicidal gas chambers were to be set up or have ever been operated in Riga.

c) The “gassing apparatus” could also not have been a homicidal “gas van” either, as gas vans could not have been “manufactured on the spot.” In addition, retrofitting a truck to serve as a “gas van” would not



have required a chemist, but rather a mechanic, and if the exhaust gases of such a vehicle had been used for the murder as claimed, this procedure would not have been any more dangerous for the operators than any other usual tail pipe (in contrast to a producer gas generator, for instance).

I posit instead that these devices were disinfestation chambers for the following reasons:

a) They were to be set up next to living shelters for deported Jews, so these Jews were meant to be kept alive, also by means of fighting insect-borne diseases. This is in keeping with the necessity to maintain high hygienic standards in crowded living conditions (cf. Crowell 2000, p. 65).

b) In late 1940 the chief chemist of the German company distributing Zyklon B described a new disinfestation chamber system using this insecticide. This “apparatus” was subsequently produced centrally in large numbers and shipped and installed throughout Germany and the occupied territories to fight insect-borne diseases (Peters/Wüstinger 1940). Wartime restrictions on iron allotments, however, precluded that sufficient numbers of the device could be produced.

c) Instead of using a pre-manufactured delousing apparatus, a makeshift Zyklon B delousing chamber could easily be built on the spot, as was done in many concentration camps, although such makeshift solutions were “not without danger,” indeed.

It has also been argued that this document may actually be a forgery. But since these “gassing apparatus” are not an object of this study, I will not address the issue further.

### 2.3. German Special Vehicles

Orthodox historiography about the Third Reich is full of speculations about the real meaning of so-called “code words” used by Third Reich officials in a wide variety of documents. “Gas vans” are no exception to this rule. As we will see later, there are several German documents frequently quoted in the context of the so-called “gas vans” which include words like “*Sonderwagen*,” “*Sonderfahrzeuge*,” or “*Spezialwagen*,” all of which translate to “special vehicle.” Except for the *Einsatzgruppe* report discussed in chapter 2.2.8., there is no known German wartime document using the term “gas vans.” The mere appearance of terms like “*Spezialwagen*” prompted German historian Matthias Beer to claim in his article on the alleged German wartime “gas vans” (1987, p. 403, note 5):

*“The connection [of terms like Spezialwagen] with the camouflage word Sonderbehandlung [special treatment], i.e., killing [...] is obvious.”*

Although it might seem obvious at first sight, this is so only because modern historians have become conditioned to see such a link, even if it doesn’t exist. A brief look into the nomenclature of German Wehrmacht vehicles would have prevented Beer from jumping to such conclusions, because every vehicle of the German armed forces which was not a merely repainted vehicle taken from civil serial production but which was custom-made for the armed forces was called “*Sonder(kraft)fahrzeug*” (special [motor] vehicle). Hence the German Wehrmacht had hundreds of such “*Sonderkraftfahrzeuge*,” which were known as “*Sd. Kfz 1*” to “*Sd. Kfz 250*” and higher (Davies 1973; Milsom 1975; Oswald 1990; Frank 1992), and these vehicles also included all the German armored vehicles (tanks), which were never officially called *Panzer*.<sup>61</sup>

A different issue is the term “*S-Wagen*,” which can also be found in German wartime documents connected with the alleged “gas vans.” Although Beer believes this term to be an “abbreviation of *spezial* or *sonder*” (*ibid.*), this isn’t true either. The “*S*” referred to the type of drive (Oswald 1990, p. 177; similar Spielberg 1977, pp. 153f.):

<sup>61</sup> See also <http://en.wikipedia.org/wiki/Sonderkraftfahrzeug>;  
[http://en.wikipedia.org/wiki/List\\_of\\_SdKfz\\_designations](http://en.wikipedia.org/wiki/List_of_SdKfz_designations).

*“The standard vehicle types were known as S-types, whereas the A-types had all-wheel drive, while being identical in every other respect.”*

John Milsom’s 1975 documentation *German Military Transport of World War II* contains several illustrations apparently stemming from a secret contemporary German document with the title *Bildermappe. Eingeführte Waffen und Geräte* (Picture Folder. Introduced Weapons and Devices). Interestingly, some of the vehicles listed were used for poison gas detection and to decontaminate people, clothes, and gas masks using hot water, steam, and hot air. They were designed to be used in case of gas warfare, but fortunately were never used. These vehicles had cargo boxes which could be sealed hermetically and which looked rather peculiar. This may have contributed to the creation of the story about gas vans – in spite of the vehicle’s purely sanitary function. Illustrations of some of these vehicles can be found in Appendix 8.

Another important aspect is disinfection, that is: the killing of vermin, such as fleas and lice. Fleas and lice carry human pathogens which can cause severe illnesses, such as typhus and plague. Typhus and plague epidemics, not weapons, have always been the primary killers during wars, caused by the deterioration and collapse of hygienic conditions. Fighting epidemics therefore means fighting the insects spreading the disease. While Germany fought the war in the east, the issue of disease control was always present. Disinfecting – or in the vernacular: delousing – the soldiers’ clothes and equipment was important, but since the soldiers had to constantly move, so did the disinfection units.

Even Germany’s enemies reported about these units, for instance the British *Times* of 30 Dec. 1941, p. 3 (cf. Rudolf 2010, p. 258):

**THE  TIMES**  
**“SPREAD OF TYPHUS IN EAST EUROPE**  
**‘MENACING CONDITIONS’**  
 FROM OUR SPECIAL CORRESPONDENT

STOCKHOLM, DEC. 29

*German references to typhus, or merely to ‘epidemics,’ in Poland, the Ukraine, the Baltic States, and particularly in Lithuania, are becoming ever more frequent, but few details are allowed to pass through the censorship to give an idea whether its prevalence is really so serious and so widespread as the precautions suggest. The*

*Germans have now introduced mobile delousing squads with special vans, and they are already working hard in the regions bordering on Russia, where the Germans are organizing winter quarters for soldiers from the Eastern front."*

Such mobile delousing units employed either some kind of poisonous substance like Zyklon B (hydrogen cyanide) or simply hot air or hot steam in order to kill pests. In contemporary British expert literature on disinfestation we read about the hot air method (Busvine 1951, p. 85f):

*"Insects are not very resistant to high temperature; they die if their bodies are raised to about 60°C (140°F) for five or ten minutes [...]. The destruction of insects by heat has been quite widely practised, both for disinfesting articles (e.g., clothing, bedding, wooden articles and food) and for disinfesting premises. The use of heat does not call for any special experience. Such risks as do exist (scorching, fire) are obvious to the simplest workman. [...] Hot air is the most satisfactory heat-disinfesting agent for destroying insect pests. [...] The most efficient hot air disinfestor which is reasonably mobile and thus adapted to Service requirements, is the [1940] Millbank apparatus which employs the forced draught principle."*

To be effective, a disinfestation van's cargo box had to be sealable and in case of hot air or steam disinfestation also insulated. Where poisonous substances were used, these vehicles were probably also equipped with warning signs and symbols about the potential danger emanating from them for the operating personnel and for bystanders.

Regarding the use of disinfestation methods at the eastern front by German units Berg pointed out (1987, p. 77):

*"The high temperature approach, whether it involved steam or hot air, was used more often in Eastern regions occupied by the Germans. This was because of the shortage of the trained specialists which were needed whenever one worked with Zyklon-B."*

German wartime expert literature describes in detail the technology used in one type of delousing/disinfestation van, which was meant to replace older systems, which had either been unreliable or damaging to the disinfested goods (Dötzer 1944, p. 29):

*"The combined hot air–steam–hot air method [...], system Hygiene Institute of the Waffen-SS-Goedecker, works according to the following new principle for mobile units:*

*The goods to be disinfested are suspended loosely in a closed chamber mounted on a vehicle. It is first pretreated for some 20*

*minutes with agitated hot air of 80 to 90°C. The hot air is generated by an equally mobile heat exchanger (heat source: steam) and is pressed through the goods to be disinfested with a strong fan. Subsequently the same chamber is charged for some 20 to 30 minutes with streaming, pressurized steam of 110°C and 0.5 atmospheres. Afterwards the steam is removed by agitated hot air of 80 to 90°C, and in addition the goods are post-treated and dried for some 15 minutes with agitated hot air. In this way an impeccable degree of disinfestation is achieved while being very gentle to the fabrics and avoiding a change in shape of the goods to be disinfested.”*

Since modern devices weren't always to come by at the eastern front, improvised solutions had to make do at times. In this regard the *Heeresdienstvorschrift* (German Army service regulation) 195/6 of 1942 concerning hot “air” disinfestation devices mandated the following about a makeshift solution:

*“III. Disinfestations*

*[...]*

*c) Disinfesting with exhaust gases*

*Disinfestations with [hot] exhaust gases from combustion engines, preferably Diesel engines (no Otto [gasoline] engine for their increased danger of carbon oxide), requires the following accessory parts, which can be improvised:*

- 1. 1 distribution funnel,*
- 2. 1 bendable metal hose*
- 3. 3 rolls of asbestos tape of thickness 3, 4 and 5 mm, each 3 m long.*

*For disinfestations with exhaust gases in the E-Baracke 42 [disinfestation shed 42] a 100 HP Diesel engine suffices. The engine is to be mounted close to the shed, and the exhaust gases are to be lead toward the middle of the shed by means of a flexible hose pulled over the exhaust pipe and sealed with asbestos tape. The entry opening of the hose into the shed is to be protected with asbestos against fire hazard. The distribution funnel is to be suspended from the ceiling in the middle of the shed at about  $\frac{3}{4}$  height with the tip pointing downward. The exit opening of the metal hose is to be affixed beneath the center of the funnel so that the exhaust gases are spread out evenly in the shed. The doors are to be closed firmly. The engine is to be loaded with some 60% of maximum load. The disinfestation procedure is otherwise identical to the hot air procedure.*

*After the end of the disinfestation time, the shed is aired by opening both doors, and it may be entered for emptying only after a quarter hour.*

*The disinfested items keep being aired, and soot deposits are beaten or brushed off where needed. This procedure may be applied only in lack of other means, since it is very uneconomical.”*

Although this service regulation talks about disinfestation sheds, it is not inconceivable that a similar setup could have been used for mobile units, that is: Diesel engine powered trucks using metal hoses to feed their exhaust gases into a sealed cargo box holding goods to be disinfested. Although such a setup would be most unsuited for mass murder, it sure does the trick for hot air disinfestation.

A closer look into witness testimonies reveals that these disinfestation vans were indeed known, albeit misunderstood. The Chełmno survivor Mieczysław Żurawski stated in 1945, for example, that two gas vans operated in this camp, plus a third vehicle which was a “disinfestation truck” (Bednarz 1946c, p. 72; see chapter 3.6.2.6.).

In passing, I would like to mention the arguably technologically most advanced special vehicles of the entire war: Starting in 1943, the SS deployed mobile microwave delousing trucks in order to disinfest the clothes of inmates in the Auschwitz and Majdanek concentration camps (Nowak/Rademacher, pp. 320-322). But since these were extremely expensive and highly efficient devices to *save* the lives of inmates, orthodox historiography never utters even one single word about their existence.

## 2.4. Producer Gas Vehicles

As mentioned in chapter 1.3.1., it would be irrational to try to commit mass murder with Diesel engine exhaust gas, as it contains only low concentrations of carbon monoxide. In contrast to this, gasoline engines easily produce quickly lethal amounts of carbon monoxide, and this difference was well-known among German engineers and toxicologists since the 1930s, as Mattogno and Graf have shown (2005, pp. 123-125).

But not even gasoline engines would have been the choice of a potential mass murder, since Germany had an even cheaper, less complicated, and more efficient method readily at hand: wood gas or producer gas generators.



**Illustration 3:** A German wartime producer gas truck form Saurer (Type 5 BHw, produced until 1935; Rudolf 2003, p. 461)

As early as 1984, Friedrich Paul Berg not only pointed out that the use of Diesel engine exhaust for mass murder would have been absurd, but also that the theory of the use of *any* exhaust gases is absurd when considering that the Germans, suffering from lack of petroleum during WWII, had retrofitted almost their entire truck fleet during the war with so-called producer gas generators. They were technically rather primitive, as all that was needed for their construction was a steel container and a few pipes. By smoldering any available combustible organic material (wood, charcoal, coke) under restricted oxygen supply, these generators produced a gas mixture with carbon monoxide contents as high as 30% and more.<sup>62</sup> The vehicles equipped with these generators used this gas to fuel their engines. But since the energy content of producer gas is rather low compared to gasoline or Diesel fuel, engines thusly fed had a considerably reduced power.

But make no mistake: producer gas is lethal only *before* entering the engine! Since the engine burns the carbon monoxide, what comes out the exhaust pipe is actually quite harmless, in particular in case of Diesel engines. It would therefore not make any sense to pipe the exhaust gases of such a producer gas van into a hypothetical gassing box. For this one would have used the generator gas itself, which of course would mean that the same gas could not simultaneously be used to drive

<sup>62</sup> How easy it indeed is can be see from sequel 4 of the documentary “One Third of the Holocaust,” [www.holocaustdenialvideos.com/videos/04\\_engine\\_exhaust.wmv](http://www.holocaustdenialvideos.com/videos/04_engine_exhaust.wmv) starting at 2 min. 20 sec.

the van. Hence any use of producer gas for homicidal gassing purposes would have been very difficult during transit. Either the gas could be used for fueling the engine *or* for gassing people. Using the gas for both operations at once, that is to say, splitting it between engine *and* cargo box, would have reduced the engine's power even more and up to a critical point. Therefore this potential *ersatz* theory to rescue the "gas van" claims founders in view of the fact that all witness statements speak of the *exhaust* gas being piped into the cargo box during transit, as we will see later. (For a hypothetical design of such a producer gas murder van see Ill. 27 on p. 379.)

Berg has not only shown that half a million of Germany's trucks and vans were equipped with these generators during the war, but also that every truck and van driver had to be specifically trained to use these generators, as their gas was extremely dangerous. So any truck driver in Germany would have known how to quickly get access to cheap poison gas for mass murder. And not only the truck drivers, but also the entire elite of the Third Reich, who were involved in campaigns to promote this technology in Germany's desperate attempt to keep its rolling fleet mobile in the face of an extreme dearth of petroleum (Rudolf 2003, pp. 459-467).

So how come that anyone could come up with the ridiculous claim that Diesel engine exhaust gas was used for mass murder instead of producer gas? Well, the producer gas technology had been a recent German development and had probably not sunk into the consciousness of those spreading the story. The Diesel engine, in contrast, was a German invention of the late 19th century and was therefore well-known

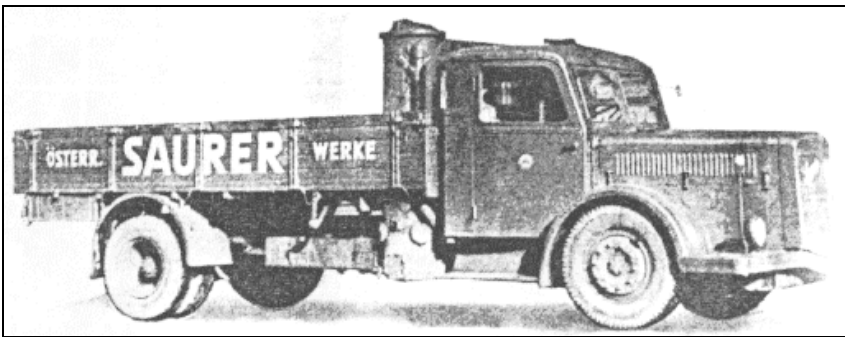

**Illustration 4:** Saurer BT 4500 with producer gas generator. A Saurer truck similar to this type allegedly was used for mass murder in Kulmhof/Chełmno – not with producer gas, but incredibly with its exhaust gas (Rudolf 2003, p. 461).



during World War II. Claiming the use of huge Diesel engines might simply have sounded more German, and during and after World War II anything “German” equaled evil.

### 3. Court Files of the War and Postwar Period

#### 3.1. Early Media Reports

Before turning to court files, I would like to start this chapter with several reports in British mass media hinting at the existence of mobile gassing devices for mass homicide. Both reports have the touch and smell of the products of Allied psychological warfare, hence may be nothing more than propaganda.

The first one is at once one of the first media reports ever about alleged German massacres of Jews. It appeared in the notoriously anti-German London *Daily Telegraph*, which had spread (false) gassing rumors already during the First World War.<sup>63</sup> On June 25, 1942, the following article could be found on page 5 of this newspaper:

**“GERMANS MURDER 700,000  
JEWS IN POLAND  
TRAVELLING GAS CHAMBERS  
DAILY TELEGRAPH REPORTER**

*More than 700,000 Polish Jews have been slaughtered by the Germans in the greatest massacre in world history. [...]*”

These charges were very general and were subsequently not substantiated. Today orthodox historiography assumes that in Poland gas vans were primarily deployed in the Chełmno camp, although the maximum claimed death toll amounts to merely half of what the *Daily Telegraph* claimed in 1942.<sup>64</sup>

A somewhat more detailed account, probably based on the same British “intelligence” (psychological warfare) sources, was published

<sup>63</sup> *Daily Telegraph*, March 22, 1916, p. 7: “ATROCITIES IN SERBIA: 700,000 VICTIMS. [...] The Governments of the Allies have secured evidence and documents [...] proving that Austria and Bulgaria have been guilty of horrible crimes in Serbia [...]. Women, children, and old men were shut up in the churches by the Austrians and either stabbed with the bayonet or suffocated by means of asphyxiating gas. In one church in Belgrade 3,000 women, children, and old men were thus suffocated. [...]”; see Aitken 1991; the first mainstream historian to mention this newspaper article was Walter Laqueur 1980, p. 9.

<sup>64</sup> The claimed Chełmno death toll actually ranges between 34,000 and 1,300,000, depending on the author; see Mattogno 2011a, chapter 11.

some three weeks later, on 16 July 1942, in the British weekly *News Review* under the title “Death refined,” which included references to stationary gas chambers in the Majdanek camp (Lublin) as well as to gas vans used in Russia to kill partisans (Sharf 1963, pp. 186f.):

*“Bringing their tastes for technical refinement into the gentle art of civilian murder, the Germans are using mobile gas chambers for execution behind the front, manned by SS and Gestapo men.*

*First introduced by the Gestapo to get rid of incurably ill people, gas was taken into special wards and released after patients had received a dose of sleeping-drug, keeping hospitals clear for wounded soldiers.*

*When war started, large gas stations were set up in Poland to kill off Jews who had been expelled from Germany to Lublin district [=Majdanek] as well as the Polish Jews who lived there.*

*No sleeping-drugs were wasted on them. They were just trussed up and finished off. Last winter gas lorries were taken behind the Eastern Front to liquidate guerillas.”*

The next time a mass murder in mobile devices committed by Germans was hinted at was in a radio speech given by German writer Thomas Mann, who had emigrated to the U.S. in 1933 and whose anti-German propaganda speeches were aired by the British during the war (Mann 1945). Mann’s speeches clearly spread Allied atrocity propaganda, as Thomas Kues has shown in his analysis (Kues 2010). To name just one of his outrageous propaganda lies, Mann claimed for instance that the Germans were exterminating the French and had a plan of killing 20 millions of them! The “gas vans” occurred in a speech aired on 27 September 1942 (Mann 1945, p. 73):

*“In Paris 16,000 Jews were herded together within a few days, loaded onto cattle cars and sent away. Whither? One who knows is the German train engineer who has been reported about in Switzerland. He fled there after several times having to drive trains filled with Jews, which were halted on an open stretch of track, hermetically sealed, and then gassed through. The man could not stand it anymore. Yet his experience is far from exceptional. A precise and authentic report is available on the killing of not less than 11,000 Polish Jews with poison gas. They were brought to a special execution field near Konim [correct: Konin] in the Warsaw District, put inside wagons which had been sealed airtight, and transformed into corpses within fifteen minutes. We have a detailed description of the*

*whole process, of the screams and pleas of the victims and the merry laughter of the SS Hottentots, who took fun in performing their task.”*

Considering that Mann’s speeches are riddled with lies and distortions, these few lines can hardly be seen as proof for anything. Mann’s first claim of French Jews gassed while aboard cattle cars is untrue even in the eyes of orthodox historiography, but it is interesting nevertheless, as seasoned revisionist Friedrich P. Berg has maintained for years that such a procedure would actually have been feasible, although it never happened (Berg 1993).

Since these *British* media reports have been the first published references to “gas van” murders, the origin of such claims in general may not be Soviet in nature, as the following chapters suggest. It appears that the Soviets simply picked up the idea from the British and elaborated on it further.

## 3.2. The Krasnodar Trial

### 3.2.1. Prehistory: Soviet Gas Vans

In his summary article about the “gas vans,” German historian Matthias Beer posits the following (1987, p. 403):

*“The term ‘gas vans’ refers to a special creation of the Third Reich, namely a heavy vehicle on whose chassis an airtight body had been mounted in which people were killed by means of the introduction of exhaust gas.”*

As early as 1991 German political scientist Udo Walendy has pointed out that the Third Reich could *not* claim to be the inventor of such an evil device, even if the claims by orthodox historiography were true (Walendy 1991, pp. 35f.) – at least if one is inclined to believe the hearsay statements as published by Soviet dissident Pyotr Grigorenko. In his *Memoirs* he recounts what a former friend, Vasily Ivanovich Teslya, had told him (Grigorenko 1982, p. 208f.):

*“Once, when we were discussing fascist atrocities, I said, ‘What beasts they must have been and how absolutely corrupt to have thought up gas wagons.’*

*In reply Teslya said, ‘Are you aware, Pyotr Grigoryevich, that we invented the gas wagon for use on the so-called kulaks?’*

*'In the prison in Omsk one day a fellow prisoner called me over to a window which opened on the inner court. There was a shutter on the window, but through a crack we could see a door into another prison building.*

*'In a short time a Black Maria<sup>65</sup> rolled up. The door in the building opened and guards drove people into the open doors of the prison van. Well over thirty prisoners jammed into the Black Maria standing up. The doors were forced shut by the guards and the van departed. I was going to leave the window but my cellmate said: 'Just wait a bit. They will come back soon.' And they did. When the van doors were opened black smoke poured into the air and corpses fell out onto the ground. Those which did not fall out by themselves were pulled out with hooks by the guards. Then all the corpses were dropped into a nearby basement sewer hole. Every day for a week we watched this happen. That other wing of the prison was known as the 'kulak' wing.'*"

It goes without saying that the probative value of this story from hearsay is rather low. If put into the context of well-documented Soviet killing methods and experiments using a wide variety of poisonous gases and other substances, however (see Bobrenjow/Rjasanzwe 1993, pp. 43, 171; Baldajewa 1993; Volodarsky 2009), it seems indeed that the sick minds coming up with the idea of "gas vans" can be found within the pre-war Soviet secret services.

In 1994 U.S. engineer Friedrich P. Berg reported about a four-part TV documentary with the title "Monster: A Portrait of Stalin in Blood" aired in the U.S. in 1993 about the collapse of the Soviet Union (Gauss 1994, p. 342). One segment of the second part of the series subtitled "Stalin's Secret Police," is of special interest, as it confirms what we suspect. At one point KGB officer Alexander Michailov states the following:<sup>66</sup>

*"We've come across evidence that long before Hitler's gas vans came into being, Isai Davidovich Berg invented secret gas vans in Moscow. It was a simple airtight van in which prisoners were delivered, and when necessary, carbon monoxide exhaust fumes were piped into the van."*

<sup>65</sup> Soviet inmate transportation van.

<sup>66</sup> [www.youtube.com/watch?v=itPPRxy\\_AQ4&feature=related](http://www.youtube.com/watch?v=itPPRxy_AQ4&feature=related); the relevant scene starts at 3 min. 21 sec.

It goes without saying that the van could not have been airtight in a strict sense, if exhaust fumes were to be delivered into it. As to the type of engine used, F.P. Berg wrote (in Rudolf 2003, p. 456):

*“Diesel engines were not mentioned [in the documentary]. This is explained by the fact that all pre-war trucks in the Soviet Union had only gasoline engines. There were no Diesel engines, since the entire transportation system in the USSR was based on earlier, western engine types such as that of Ford Motor Co. More than likely, the Soviet allegations of [German] gas trucks are truly based on the Soviets’ own mass murder technology to which they simply added Diesel engines to make them seem more sinister and, most of all, more German.”*

The revelation about Soviet gas vans was confirmed two years later by Russian writer Michael S. Voslensky, who had been a Russian interpreter during the Nuremberg Trials, but who was later exiled as a dissident. After the collapse of the Soviet Union he gained access to the once secret files of the former Soviet Secret service NKVD. Among other atrocities found there, he also reports the following (1995, pp. 28f.):

*“And one final detail. During World War Two the people in the Soviet Union were indignant when they learned that the German security services used retrofitted vans to kill people with exhaust gases. In the Soviet media these gas vehicles were called ‘soul vendors.’ They really were a diabolic invention, and their inventors were criminals.*

*Only this wasn’t a German but a Soviet invention. In the USSR a truck was constructed whose exhaust gases were piped into the enclosed cargo box. The inventor was a certain Berg, head of the economic department of the NKVD for Moscow and the area around Moscow. Long before the war – in 1936 – one began to use Berg’s invention. Berg himself was executed in 1939 as a participant at an alleged ‘conspiracy of NKVD members against the leadership of the State.’ Of course this plot was an invention. Nevertheless the reader will hardly be able to feel pity for Berg.”*

So when war broke out between Germany and the Soviet Union in June 1941, the stage was set, and the Germans had no idea what was coming their way.

### 3.2.2. Background and Conditions

Not having access to trial documents of the Krasnodar trial of summer 1943, we have to make do with an analysis of the trial published by Russian historian Ilya Bourtman in 2008 as well as with an English booklet published in 1943 by the Moscow Foreign Publishing House (*The Trial*, 1943), which is an English translation of articles published in the Soviet newspaper *Pravda*. In 1944 this booklet was followed by another publication with the title *The People's Verdict* (1944) containing the content of the former brochure (pp. 7-44) plus an English translation of the case summary of the Kharkov trial (pp. 45-124), with excerpts from interrogations of the defendants and several key witnesses. This trial will be discussed in chapter 3.3. The Krasnodar trial itself took place between 14 and 17 July 1943. Although for obvious propagandistic reasons the newspaper articles published about the trial gave the impression that German officials were being tried, this was not the case. Instead, eleven Soviet citizens were mainly accused of collaborating with the German *Sonderkommando 10a* (which belonged to *Einsatzgruppe D*) in “guarding Gestapo buildings that held arrested Soviet citizens, executing arrests, going on military searches and expeditions against the partisans and peaceful Soviet citizens, [and] exterminating Soviet citizens by hanging, mass shootings, and use of poison gases” (Bourtman 2008, p. 251). It is the latter aspect in which we are interested. Just one day after the verdict had been handed down, eight of the defendants were publicly hanged on the main square of Krasnodar, underlining the show character of the trial, whereas the remaining three had to serve long prison terms. Bourtman writes about this trial (*ibid.*, p. 250; unless stated otherwise, all page numbers in this subchapter are from this):

*“From the apologetic and self-denouncing defendants, to the largely inconsequential lawyers, to the stern and ruthless prosecutor, each actor had a scripted part to play. Just as important as the trial itself (if not more important) was the coverage it received. The large numbers of people who came to see the executions underscored the increasing psychological impact of the Soviet war crimes trials. In Krasnodar, the public execution was attended by thirty thousand spectators. The Soviet press (including children’s newspapers) reported every word uttered by the prosecutor; film crews re-*

*corded the trial, and edited segments were shown in cinemas around the Soviet Union."*

Although it has been suggested that this trial and others of its kind had been staged by the Soviet Union as a "retaliation" for the German propaganda exploiting the discovery of the mass graves at Katyn (Sanford 2005), this is not entirely true, as the indictment against the defendants actually dates from 13 February 1943 (*ibid.*), that is, *before* the discovery of the Katyn mass graves. Hence the proceedings as such were not influenced by Katyn, yet probably their propagandistic exploitation was (p. 260). In fact, at least as important was the need to deter the population of the Soviet Union from collaborating with the Germans, whom they conceived as their liberators from Stalinist oppression, or as Bourttman puts it (*ibid.*):

*"There is reason to believe that the Soviet leadership, its views clouded by ideological assumptions concerning a supposed 'friendship among nations,' underestimated the willingness of Soviet citizens to engage with and assist the German occupying forces. Officials hoped that the widespread media coverage of the trials held during the war would have the effect of minimizing ongoing collaboration in the still-occupied Soviet lands and preventing future collaborationist activities. The Soviet authorities knew that some citizens in the borderlands had welcomed the German occupiers as liberators; rooting out these and other 'enemies of the state' was essential to the reaffirmation of the Soviet regime's authority. Trials of Soviet collaborators sent a clear message that those who participated in national movements aimed at usurping the power of the Soviet state would be dealt with harshly."*

That these trials were indeed nothing else but propaganda shows can be gleaned from their conditions. Here is, for instance, what Bourttman writes about the methods used during the Krasnodar trial to extract confessions from the defendants (pp. 253f.):

*"Some historians, including Hostettler, have noted that Soviet interrogators used coercive methods to extract confessions: 'The methods used during months of interrogation included confinement in a punishment cell too small to move in, intolerable pressure by teams of inquisitors working for hours and days at a stretch, savage beatings, prolonged deprivation of sleep, and promises of leniency or pardon in return for co-operation.' Prusin suggests further that, at least for more senior individuals, 'the descent from a position of*



*authority to the status of helpless prisoner gravely undermined their moral strength.’ Documents from the trial in Krasnodar suggest that the defendants relinquished their claims of innocence only as a result of grueling interrogations and out of a sense of hopelessness. For example, during his first interrogation, on March 25, 1943, Tishchenko told his interrogators that he was innocent of most of the crimes with which he was charged; only after three months of interrogations did he plead guilty to all. Yet for Soviet authorities, everything was much simpler: only the guilty would confess.” (For references see there.)*

In addition to “pedagogical” reasons, the trials also had other political motivations, as Bourtman notes, who also aptly describes the theatrical role all actors had been assigned during these trials (pp. 255f.):

*“Thus, [...] class issues continued to play an important role in determining state violence during and after the war. The Soviets used the military tribunals [...] as an instrument for cleansing Soviet society of elements perceived as unfaithful.*

*The three defense attorneys in the Krasnodar proceedings had little impact on the trial’s outcome. Because confession was considered the ultimate proof of a defendant’s guilt, and all of the defendants had been made to confess numerous times during the pre-trial interrogations, the lawyers could not have mounted a cogent defense even if they had wanted to. The tribunals were structured in such a way as to give the defense attorneys as marginal a role as possible; their participation, it seems, was merely symbolic—intended to demonstrate the fairness of the proceedings. [...] Unlike the judges and the prosecutors, defense lawyers were not allowed to cross-examine the witnesses. In accordance with the June 1941 decree, no pre-trial meetings were allowed; defendants and their lawyers met for the first time on the first day of the trial before the proceedings began. As a result, the lawyers could do little in court other than plead for leniency for their defendants [...].*

*For their part, the judges’ role was to support the prosecutor, intervening only to recapitulate horrific incidents. The three judges in Krasnodar fulfilled this role precisely. Above all, they pressed the defendants for details of the atrocities they had [allegedly<sup>67</sup>] commit-*

---

<sup>67</sup> Despite the horrific conditions of these trials described by Bourtman, he never utters even a word of doubt that the crimes claimed by the prosecution could have been invented or grossly exaggerated.

*ted. For example, they relentlessly questioned defendant Nikolai Pushkarev, extracting from him [alleged] details of mass arrests and executions of Soviet civilians. Throughout the trial, the judges interjected comments intended to highlight the appalling nature of the defendants' acts of collaboration.*

*In sharp contrast to the groveling lawyers, the State Prosecutor commanded overwhelming authority during the military tribunals. His role was that of director; generally theatrical and overbearing, he set the tone for the trial and orchestrated it. He unyieldingly dramatized and embellished the role of the accused in the crimes [allegedly] committed, but at the same time was careful to implicate the German government and high command, as well as the German officers in charge of a particular region. [...State Prosecutor] Yachenin described in typically overblown terms the historical importance of trying the defendants: 'Today Soviet law will mete out justice to the traitors, fascist hirelings, and boot-lickers now in the prisoners' dock. Tomorrow the court of history, the court of freedom-loving nations of the world, will pronounce its inexorable verdict on the bloodthirsty rulers of Hitlerite Germany and all its associates—on the enemies of mankind who have plunged the world into the welter of the present war. Not one of them will escape stern retribution! Blood for blood, death for death!'*

*[...] the trial in Krasnodar established the model for the thousands of trials that followed. [...] And yet, for the Soviet government, the primary significance of the tribunals lay not in the punishment of the thousands of collaborators and German POWs, but in the propaganda value that could be extracted from them. [...]*

*Coverage of the Krasnodar Trial both within and outside the Soviet Union amounted to a highly organized public relations campaign. The highest levels of the Soviet regime, including Stalin himself, received daily reports on the progress of the trials [...]. But it seems clear that they [the Soviet leaders] saw the trials as an instrument of propaganda – as a means to publicize German atrocities [allegedly] committed on Soviet territory."*

This attitude was even confirmed by Joseph Stalin himself, who, as the probable initiator of those trials, must have known best about their propagandistic nature. According to one source, Stalin is said to have confided to an interlocutor in private that this trial was most benefi-

cial for his propaganda, but that the allegations made were “exaggerated” (Bishop, p. 33).

### 3.2.3. Gas Van Claims during the Krasnodar Trial

But now back to the gas vans. Bourtman states that none of the defendants of the Krasnodar trial had been accused of having been involved in any act of mass murder, so statements about gas vans during the trial had an exclusively declamatory nature and were very vague. They served clear propaganda purposes (p. 258):

*“Children’s newspapers also covered the trial. One image that appeared often in accounts published for children was that of the ‘murder vans’ (as the newspapers dubbed them) in which some 6,280 Soviet citizens were [allegedly] gassed during the course of the regional occupation. For many Soviet citizens, it seems, the murder vans were emblematic of Germany’s ruthless efficiency and inhumanity. At every turn, prosecutor Yachenin exploited the image of the vans, and this focus was reflected in the dozens of newspaper reports devoted to them. On July 21, 1943, Pionerskaia Pravda, a weekly geared to children between the ages of 8 and 14, ran an article entitled ‘Hitler’s Murder Vans.’”*

Since I have not yet seen any of these pictures of alleged gas vans published in the Soviet media during that time, I cannot currently comment on them. I will instead quote a few excerpts from *The People’s Verdict*:

*“Lastly, the investigation revealed that many thousands of Soviet citizens were put to death by asphyxiation by means of carbon monoxide in motor vehicles specially equipped for this purpose, known as ‘murder vans.’*

*In the autumn of 1942,<sup>[68]</sup> the Germans began to utilize specially equipped motor vehicles, which the population called murder vans, for the purpose of doing away with Soviet citizens.*

*These murder vans were covered five-ton or seven-ton grey-painted motor trucks, driven by Diesel engines. The interior of these vans was lined with zinc-plated sheet iron. At the back they had double doors which closed hermetically. The floor consisted of a*

---

<sup>68</sup> Note that orthodox historiography assumes the fall of 1941 as the beginning of these gasings.

*grating, beneath which there was a pipe that was connected with the exhaust pipe of the engine. The exhaust gas from the Diesel engine, which contained a high concentration of carbon monoxide, penetrated the interior of the van, causing the rapid poisoning and death from asphyxiation of the prisoners confined in it.*

*[...] Before being dragged from the cellar the prisoners were stripped of their clothing; then they were bundled into the murder van 60 to 80 at a time. The doors of the van were then hermetically closed and the engine started. After standing with the engine running for several minutes, the van would drive to an anti-tank trench which had been dug outside the Measuring Instruments Factory on the outskirts of Krasnodar. As a rule, the murder vans were escorted by a convoy of police from the Sonderkommando SS-10-a. By the time the vans reached the anti-tank trench the people were asphyxiated by the gas. The bodies were flung into the trench and buried. Men, women and children were bundled into the van without discrimination.” (pp. 8f.; all subsequent page no. in this section from it.)*

Just like in many other report and witness statements, the claim is made here as well that the cargo box into which the persons to be “liquidated” were herded was sealed hermetically, since it makes no sense to seal the back door(s) hermetically but to leave the rest of the cargo box unsealed. I have stated several times that the system was not operable under these circumstances (see chapter 1.3.2.). Furthermore it is simply a lie to claim that the “exhaust gas from the Diesel engine” “contained a high concentration of carbon monoxide” “causing the rapid poisoning and death from asphyxiation of the prisoners confined in it.” I posit that death by suffocation would occur due to lack of oxygen, which would occur sooner or later in a space into which 85 persons had been crammed, even without the need to have the victims inhale Diesel exhaust gases – under technically highly dubious circumstances.

*“Yevdokia Fedorovna Gazhik, who, one day, witnessed the forcible loading into the ‘murder van’ of an arrested woman and her five-year-old daughter, stated as follows:*

*‘Into this “motor bus” the Gestapo men were forcibly dragging a woman about thirty years of age. The woman refused to go into the van, resisted, and all the time tried to reach a little girl behind her, four or five years old, who was crying: “Mummy, Mummy, I want to ride with you.” Unable to subdue the arrested woman, one of the*

*Gestapo men seized the little girl and smeared her lips and nose with a thick black liquid. The child instantly fell unconscious. The Gestapo man picked her up and threw her into the van. On seeing this, the mother uttered a wild shriek and rushed at the Gestapo man. After struggling with the woman for several seconds the Gestapo man succeeded in overpowering her and dragged her into the van.”* (p. 9f.)

This statement is interesting due to its similarity to claims regarding the alleged murder methods used in the Sobibór camp, as attested to by Soviet witness Alexander Pechersky, who also claimed the use of some mysterious black/dark substances to poison people (Graf/Kues/Mattogno 2010, p. 70). It is today either dismissed or ignored by orthodox historians as completely baseless, as no such rapidly acting poisonous black substance has ever been identified. Hence this witness statement may be a case of “cross-fertilization” of “independent” witnesses – or merely a variation of mankind’s association of black with evil.

The pages 13 and 32 of *The People’s Verdict* deal with forensic examinations of mass graves allegedly containing victims of homicidal gassings by means of “gas vans.” I have analyzed these claims in chapter 1.2., to which I refer.

*“Tishchenko answered in great detail showing that he was quite familiar with the whole business. These vans were five-ton or seven-ton motor trucks, he said, with bodies built over them. These had double walls [probably doors] and false windows which gave them the appearance of motor buses. At the rear of each vehicle there was a door which closed hermetically. The floor consisted of a grating under which ran the exhaust pipe from the Diesel engine by which the vehicle was driven. The exhaust gas penetrated the interior of the vehicle. When the vehicle was standing with the engine running, death ensued within seven minutes; when it was in motion death ensued in ten minutes. [...] Tishchenko stated that one day he was present when 67 adults and 18 children were bundled into a ‘murder van.’”* (pp. 16f.)

As mentioned before, it is not possible to pipe exhaust gas into a hermetically sealed cargo box for more than a few minutes without the box giving way in one way or another. If assuming some technical arrangement that would have allowed this device to function (like openings in the cargo box permitting excess gas to escape), and that suffocation had occurred due to lack of oxygen, it is obvious that the amount of

gas produced (as well as its content of carbon monoxide) was higher for a Diesel engine during engine load (that is, when the van was moving) than while idling, so that the victims would have died faster during transit than when the vehicle was standing. Hence the witness' statement is illogical in this regard.

*"The next witness to be examined was Kotov, [...]*

*[...] Several minutes later I felt bad and began to lose consciousness. At one time I had taken a course of anti-gas bombing drill and I soon realized what was happening – we were being poisoned with some kind of gas. I tore off my shirt, moistened it with my urine and pressed it to my nose and mouth. I began to breathe more easily, but I lost consciousness all the same. When I came to I found myself in a pit among scores of dead bodies. I managed to climb out of the pit somehow and crept home with great difficulty."* (pp. 28f., similar on p. 11)

It is too bad that carbon monoxide is insoluble in water, hence his urinated shirt wouldn't have helped him a bit. This statement indicates, though, that gas warfare hysteria prevailing throughout Europe in that era due to traumatic experiences during the trench warfare of the First World War have left their psychological traces, upon which the propagandists played their tune (see Crowell 2000).

The witness Inozemtseva stated:

*"Going on duty on 23rd September, I saw a large dark grey vehicle in the courtyard, which looked something like a furniture van."* (p. 29)

This is in accordance with the fact that the only truck ever suspected to have been a gas van, which was investigated for this very reason by a Polish expert commission after the war, turned out to be mere moving trucks, indeed (see p. 33f.). Hence the witness unwittingly and unwillingly hit the jackpot with this statement. Of course, with this statement he contradicts the claims quoted before that the trucks had windows painted on their side, making them look like motor buses.

It is worth noting that "Jews" were never mentioned as the victims of the claimed murders, be they in gas vans or otherwise. Rather it is claimed that the extermination measures were aimed mainly at eliminating children, the sick, and the disabled from hospitals, clearing them out for wounded German soldiers (pp. 8, 10-13, 27-30, 35). The commission's victim count of "only" 7,000 seems also ridiculously low, if considering that the Just document alone claims 97,000 victims for just

6 months. Maybe both figures have the same source: After the war, with hundreds of thousands and millions of victims claimed for each and every alleged German murder location, the 7,000 figure of the Krasnodar trial was probably no longer horrific enough, and hence maybe it was amended by adding a nine: 97,000.

To summarize: What we have found out about this trial and the evidence presented does not yield any new evidence about the existence of gas vans. Quite to the contrary, the circumstances of the trial and the claims made increase our skepticism.

### 3.3. The Kharkov Trial

The conditions of the Kharkov trial were the same as those of the Krasnodar trial, hence I refer to what I have stated in the previous chapter.

The Kharkov chapter in *The People's Verdict* is much longer than the one on Krasnodar primarily due to lengthy quotes from confessions made by the defendants and from witness statements. I will subsequently quote a number of them, restricting myself to passages containing information about the alleged gas vans and to such passages requiring comments for other reasons. I insert due comments after each quote.

*“As established by the investigation similar ‘gas lorries,’ which were nicknamed ‘murder vans,’ were used by the Germans for murdering peaceful Soviet citizens not only in Krasnodar but also in Kharkov.*

*These vans, as testified by the German defendants in the present case and also by witnesses who witnessed the crimes committed by the Germans, are large closed trucks of dark grey colour, driven by Diesel engines. The vans are lined inside with galvanized iron and have airtight folding doors at the back. The floor is equipped with a wooden grating under which passes a pipe with apertures. This pipe is connected to the exhaust pipe of the engine. The exhaust gases of the Diesel engine, containing highly concentrated carbon monoxide, enter the body of the van, causing rapid poisoning and asphyxiation of the people locked up in the van.”* (p. 49)

It is a simple fact that Diesel exhaust gases never contain “highly concentrated carbon monoxide.” This quote is the first time a probably horizontal “pipe with apertures” running underneath the grate is men-

tioned, a device not referred to in any of the extant documents. It would have been completely superfluous, as a simple hole in the floor or wall would have sufficed to introduce the gas, which would have spread out evenly already due to the victims' movements. The only effect of such a horizontal floor pipe would have been to render the production of these vans more expensive and complex, to complicate the cleaning of the van and to make it more prone to damage. Later we will encounter this claim frequently during West-German trials.

*"The witness Obersturmbannführer Heinisch stated:*

*"In the S.D. (Security Service) a so-called "gas lorry" was manufactured. Outwardly it hardly differs from an ordinary prison van, but its body is hermetically closed and exhaust gases pass from the engine along a special pipe to the body. This van holds several dozen persons. They are usually told that they are to be dispatched to another jail or camp. When the van starts the gases penetrate inside the lorry and the people are asphyxiated."* (p. 50)

*"The investigation has also established that after murdering Soviet people in the 'murder vans,' the German invaders conveyed their bodies to the outskirts of Kharkov, dumped them in empty barracks or other half-demolished buildings, poured petrol over them and set them on fire."* (pp. 51f., similar pp. 86, 105)

It can safely be assumed that this and similar stories proffered by witnesses during this trial were completely made up. When the German Armed forces entered larger Russian cities, some of its buildings had been damaged by the fighting, and some had been destroyed on purpose by the retreating Soviet forces following their scorched earth policy. Hence the German occupational forces had massive problems finding sufficient shelter for themselves and for the local population. Under these circumstance, deliberately burning down some of the remaining buildings did certainly not happen, all the more so since this was a highly unsuitable method to incinerate the remains of the alleged mass murder.

*"[...] Hitler was extremely annoyed about the talkativeness of persons who in some way or another had learned about the existence of the 'gas lorries.' As a result of this talkativeness, von Alvensleben said, and also as a result of the carelessness of certain S.D. and Gestapo chiefs, documents concerning the 'gas lorries' had fallen into the hands of Russians."* (p. 53)



No such document was ever presented by the Soviets. Hence it can be assumed that this story was made up as well.

*“President: Describe what the ‘gas van’ is like.*

[Wilhelm] Langheld: *As far as I remember the ‘gas van’ is a vehicle dark grey in colour, completely covered in, having hermetically sealed doors at the back.*

*President: How many persons can a van hold?*

*Langheld: Approximately 60 to 70 persons.*

*President: Under what circumstances did you see the van in Kharkov?*

*Langheld: I was at 76, Chernishevsky Street at the H.Q. of the S.D. and heard a terrific noise and screaming outside.*

*President: What happened then?*

*Langheld: A gas van at that moment had driven up to the main entrance of the building, and one could see how people were being forcibly driven into it, while German soldiers were standing at the doors of the van.”* (p. 65)

Defendant Hans Ritz stated:

*“It was an ordinary closed army transport lorry, only with an airtight body. Lt. Jacobi opened the doors of the machine and let me look in. Inside the machine was lined with sheet iron, in the floor was a grating through which entered the exhaust gases of the motor which poisoned the people inside the van. [...] I should add that they numbered about 60 persons.”* (pp. 69f.)

[Reinhard] *“Retzlaff: In March, 1942, when I entered the courtyard of Kharkov Jail, I saw there a large van painted dark grey.”* (p. 77)

*“Prosecutor: How many Soviet citizens in all were exterminated by means of the gas van?*

*Retzlaff: As S.D. man Kaminsky told me, more than 5,000 people were destroyed in March. Taking into consideration this figure as well as the fact that the gas van made its deadly rounds every day, it can be considered that the total number of persons put to death in Kharkov is approximately 30,000.”* (pp. 78f.)

Hence the Soviets had figured out that the 7,000 victims claimed during the Krasnodar trial wasn't impressive at all, if compared to all the other numbers being touted during that time. The numbers were therefore jacked up considerably.

*“Prosecutor: Tell the Court in detail what this van was like, how it was designed and how people were murdered in it.*

*[Mikhail] Bulanov: This machine was a huge two-axled truck of approximately five to seven tons capacity. It was painted grey and had a six-cylinder engine. The body of this machine had folding doors which closed hermetically. It was evidently made airtight by means of the rubber lining of the door.*

*Prosecutor: The lining of the door?*

*Bulanov: Yes, the lining of the door. The body is lined inside with galvanized iron and there is a wooden grating in the lower part of the body.*

*Prosecutor: That means that this grating forms the floor?*

*Bulanov: Yes, this grating forms the floor on which the prisoners stand. In the lower part of the truck is the exhaust pipe of the engine through which the exhaust gas passes into the body. After the people are put into the truck, the door is closed, the engine is started and the truck is driven to the unloading point. During this time the people are done to death.” (p. 85)*

This is a most determined confirmation that the cargo box was indeed hermetically sealed – which proves that this witness statement is simply a lie. But the witness must have known it, because he worked on such a van, or so he claimed (p. 87).

*“Prosecutor: Tell the Court everything you know about the gas van.*

*[Georg] Heinisch: The gas van is a kind of prison van, equipped with hermetically closing folding doors, in which exhaust gases from the engine pass along a special pipe into the body of the van, thus causing asphyxiation of all the people inside.*

*Prosecutor: How long have you known of the existence of this gas van?*

*Heinisch: I learned about its existence in January this year during a conference of District Commissars at which Lieut.-General of Police von Alvensleben was present.*

*Prosecutor: Tell the Court about this conference and what you learned there about the gas van.*

*Heinisch: Von Alvensleben stated that information concerning the gas van had fallen into the hands of the Russians. According to Lieut.-General of Police von Alvensleben, the Führer – that is, Hit-*

*ler – had ordered that there should be no further open talk about the gas van on pain of arraignment for trial by a special court of S.S.*

*Prosecutor: Have you yourself ever seen a gas van?*

*Heinisch: Yes, I saw one in the town of Rovno, but not in action.*

*Prosecutor: Did you take part in the extermination of people by means of gas vans?*

*Heinisch: No, I did not.*

*Prosecutor: Tell the Court in detail about your talk with Somann.*

*Heinisch: Somann told me that death caused by gas poisoning was painless and more humane. He said that in the gas van death was very quick, but actually death came not in twelve seconds but much more slowly and was accompanied by great pain.*

*Somann told me about the camp in Auschwitz in Germany where the gassing of prisoners was also carried out. The people were told that they were to be transferred elsewhere, and foreign workers were told that they would be repatriated and were sent under this pretext to bath-houses. Those who were to be executed first entered a place with a signboard with 'Disinfection' on it and there they undressed the men separately from women and children. Then they were ordered to proceed to another place with a signboard 'Bath.' While the people were washing themselves special valves were opened to let in the gas which caused their death. Then the dead people were burned in special furnaces in which about 200 bodies could be burned simultaneously.*

*Prosecutor: Did Somann tell you on whose instructions execution by gas poisoning was introduced?*

*Heinisch: Somann told me that in the autumn of 1942 a conference took place between Hitler, Himmler, and S.D. Chief Kaltenbrunner, at which it was decided to perform executions by means of gas poisoning." (pp. 89f.)*

This statement proves that a lie becomes unstable the more a liar talks about it. This statement is so full of preposterous claims that it should make every historian blush. Not only have the Soviets never presented any evidence about the gas vans which had fallen into their hands, but the alleged Hitler order is a complete invention as well, of which no trace exists.

How anyone could have claimed that the execution with exhaust gases would take only a few seconds is beyond me. But the best part is actually what Heinisch is telling about gassings in Auschwitz, the black

propaganda about which had been spread by the Polish underground movement since the fall of 1941. According to Heinisch, the victims in Auschwitz were gassed *while* taken an actual shower – by suddenly turning on a valve to insert the gas. Although stated with much determination, this is nevertheless utter nonsense<sup>69</sup> and merely proves that the defendant is simply parroting what was put in his mouth. On the upside, though, is the fact that this statement confirms indirectly the enormous efforts of the German authorities to disinfect the Auschwitz prisoners in order to save their lives. The propagandists simply twisted the tale to fit their purposes.

*“Heinisch: Extermination of people by gas poisoning was to take place in concentration camps.*

*President: In German-occupied territory?*

*Heinisch: There are no concentration camps in the occupied regions.*

*President: That means in Germany?*

*Heinisch: Yes.”* (p. 92)

Today the exact opposite is claimed: extermination is said to have taken place in camps *outside* of Germany proper in the camps Belzec, Sobibór, Treblinka, Chełmno, and Auschwitz (although the Polish territory around Auschwitz and Chełmno/Kulmhof had been temporarily annexed by Germany during the war). Once again this shows that at this early point of the legend, the story had not yet been carefully orchestrated.

*“[The witnesses’] testimony revealed details of the terrible tragedy enacted in the hospital, in which wounded Red Army men were being treated, after the capture of Kharkov by the Germans.*

*‘The human mind simply cannot grasp what I saw and lived through in the period of the German occupation,’ stated Witness Djinchviladze. ‘In the 8th block of the hospital there were 400 seriously wounded men who needed immediate surgical attention. They were either in the operating theatre or being prepared for operating when a dull explosion occurred. The nurses ran towards me shrieking. It transpired that S.S. men had driven up to the hospital, nailed up all the entrances and hurled two incendiary bombs into the premises. The first floor was at once enveloped in flames. The fire reached the beds of the wounded. With their clothes burning, they*

---

<sup>69</sup> About the alleged gassing procedure cf. Mattogno 2005a & b, 2010.

*crept towards the windows. Many were so weak that they fell dead after crawling a few steps. Those who reached windows and climbed onto sills were shot from tommy-guns by S.S troopers who had surrounded the building.”* (p. 102, similar pp. 103f.)

Considering that the German Armed Forces were desperate for hospital space and equipment in order to treat their own wounded soldiers, who would seriously believe that the first thing they had on their mind when occupying Kharkov would have been to set the local hospital on fire? It is more likely that the hospital, if it burned down during the early days of the occupation in the first place, was a victim of Soviet sabotage troops which the Red Army left behind in many major cities to wreak havoc among the German occupational forces.

*“The depositions of the accused and the witnesses state that in various parts of the temporarily occupied territory of the U.S.S.R. the German fascist invaders used specially equipped large vans in the bodies of which Soviet citizens were murdered by exhaust gases containing carbon monoxide. The medico-legal experts proved this beyond doubt for the first time when examining bodies exhumed in the town of Krasnodar and in its vicinity. At the same time the presence of carbon monoxide was irrefutably established by a combination of physiological, chemical and spectroscopic tests of the blood in the tissues and organs of the corpses. The same method of poisoning with carbon monoxide as was used in Krasnodar has been proved by medico-legal examination of some of the bodies exhumed in Kharkov.*

*The lorry which came to be known as the ‘gas van’ or ‘murder van,’ designed to exterminate people inside its airtight body by means of exhaust gases, must be regarded as a mechanical method for the simultaneous poisoning of large groups of people.”* (pp. 109f.)

The alleged spectroscopic test merits the same comments as those allegedly performed for the Krasnodar trial.

In summarizing, it can be concluded that, according to the two Soviet show trials, the alleged gas vans of an unspecified make and model were grey (pp. 8, 28, 29, 29, 49, 50, 65, 77, 85, 105), had Diesel engines (8, 9, 13, 17, 49, 49), weighed five to seven tons (8, 16, 85), and had two axles and six cylinders (p. 85), and most importantly: their doors closed hermetically (pp. 9, 17, 50, 65, 85, 90). This latter point plus the claimed Diesel engine renders the claims of mass gassings within the

claimed span of time (7 to 10 minutes, p. 17) technically impossible, though. I may add in passing that some witnesses claimed that the vans looked like motor buses (pp. 9, 17), moving trucks (p. 29) or ordinary prison vans (p. 50).

It is astounding that, as early as late 1943, the Soviets had prisoners in their custody who were allegedly well familiar with the “gas vans,” but that none of these vans had fallen into their hands, although it was claimed that they had been frequently deployed behind the enemy lines by the *Einsatzgruppen* (see the Becker document of 16 May 1942 and the Just document of 5 June 1942). If these prisoners knew those vans so well, how come that there are no drawing prepared by them?

Once more the trial transcript repeatedly claims as one of the major motivations for the alleged gas van murders the clearing of hospitals (pp. 54, 56-58, 74, 84, 96, 100, 102-108). It is interesting to note that Jews are not mentioned even once as the victims of these gas van murders in either trial. They were added into the story only after the war, when depicting Jews as the unique victims of every German atrocity had become all the rage.

In a later publication entitled *German-Fascist Occupation Troops in the Stavropol Area: Soviet War Documents*, from December 1943 and published by the Soviet Embassy in Washington, DC, we have a description of the gas van on page 172. According to that description, the engine was a “Sau[r]er” engine, hence with certainty a Diesel engine. The connection made here to a company called Saurer is significant, because it reappears in the infamous letter from Becker to Rauff in Nuremberg File 501-PS.

### 3.4. The Psychological Framework of Postwar Confessions

Much has been said and written about the appalling conditions prevailing during the trials against alleged war criminals in Germany immediately after the war and in the ensuing decades as well as about the many reasons for false or inaccurate confessions and testimonies. Instead of repeating or summarizing this, I refer the reader to a paper by Manfred Köhler (2003) and to the pertinent chapter in Rudolf’s *Lectures on the Holocaust* (2010, pp. 292-358). Later on, when dealing

with witness statements (chapter 4), I will return to this issue. Right now I want to focus on the desperate situation in which defendants can find themselves when the profound legal standard “innocent until proven guilty” is violated, which happens even today in states under the rule of law. In order to clarify the problems we are dealing with, I want to point out only one legal case here which unfolded in the U.S. in 1997. This case is so powerful, exactly because it has nothing to do with the topic of this book, as will become immediately clear.

In 1997 a young U.S. American navy soldier was accused of having committed a rape-murder against a female neighbor. Although he denied any involvement and passed the lie detector test, the interrogating officer did not believe him and kept him under pressure, demanding a confession. After many hours of relentless interrogations the man finally confessed. When a DNA test showed that the defendant’s DNA did not match the rapist’s DNA, the interrogation officer, instead of releasing the innocent man, assumed a gang rape and demanded that he be told the names of the assumed others involved. After days and days of interrogations, the accused finally uttered names of other soldiers he knew. They, too, were arrested and went through the same ordeal. They all initially denied any involvement; they all passed the lie detector test; yet they all confessed after so many hours and days of relentless interrogations. None of their DNA matched that of the rapist, so the interrogator asked for more names. Eventually seven soldiers were under arrest. Only by chance was the real rapist found shortly afterwards, who had raped two more women in the neighborhood and whose DNA had even been on file. Yet nobody cared to look for a DNA match in the police database.

The tragedy was that, when the case went to trial, neither the prosecutors, nor the judges, nor the jury members could believe that perfectly innocent men would confess a horrible crime they had not committed. Even though they all had initially insisted, and some of them even during the trial, that they were innocent; even though the DNA showed that they were; even though they had changed their stories multiple times along the way to adjust it to what the prosecution wanted to hear; even though the final story they had concocted about what had allegedly happened was at times absurd and contradicted material evidence; and even though the true rapist insisted that he had done it alone – the court and the jury still found the four innocent men guilty of gang-raping and murder.

This scandalous case of miscarriage of justice was thoroughly documented (Wells/Leo 2008) and led to a documentary in the U.S. public broadcasting channel PBS on Nov. 9, 2010.<sup>70</sup> In it Tom Wells expounded that the threat of capital punishment hovering over those four innocent men had a similar effect as the presentation of the torture devices had during medieval witch trials.

Hence, all it takes to make almost every person confess almost any crime is to put him or her into a desperate situation which has apparently only one exit: comply with the wishes of your tormentors. In the long run, everybody will confess. Physical abuse is no prerequisite. After endless exhausting interrogations and weeks or months of incarceration, the prospect of many more months of this and of many years, nay, decades in prison – or even of the death penalty – makes almost every defendant willing to say just about anything the interrogator wants to hear – if only the threatened punishment can be averted or ameliorated:

*We know you are guilty. If you don't confess and cooperate, we'll lock you away for the rest of your life – or maybe we will even put you onto the electric chair.*

One must keep in mind that we are dealing here with criminal proceedings of “every day” crimes in a highly developed and sophisticated legal system.

How much worse must it have been for the German defendants during the immediate postwar trials, where the defendants had no recourse to any efficient defense, where third degree torture was common practice, and where the death penalty was meted out by the hundreds? And how bad must it have been for the German defendants during the trials in West Germany ever since, where disputing the reality of the claims made by the prosecution posed the risk of an even more severe punishment for lack of contrition and repentance?

Having said this, I will now turn to the various “confessions” and witness statements made regarding the “gas vans” without repeating over and over again the basically worthless nature of such confessions.

---

<sup>70</sup> See <http://www.pbs.org/wgbh/pages/frontline/the-confessions> as well as their website with literature about this phenomenon at <http://www.pbs.org/wgbh/pages/frontline/the-confessions/false-confessions-and-interrogations>.



### 3.5. Gas Vans during the IMT and NMTs

#### 3.5.1. The Soviet Background

The gas van claim played only a minor role during the International Military Tribunal (IMT) and the Nuremberg Military Tribunals (NMTs) after the war. Not just with respect to this claim, these trials were extensions of the Soviet wartime show trials discussed before. This is not just proven by the first reference to “gas vans” during the IMT, which occurred in the indictment with indirect reference to the claims made during the Soviet show trials in Krasnodar and Kharkov (IMT, vol. 1, p. 49; shortly thereafter repeated by the Soviet prosecutor Ozol, vol. 2, p. 63):

*“In Krasnodar some 6,700 civilians were murdered by poison gas in gas vans, [...].*

*In Kharkov about 195,000 persons were either tortured to death, shot, or gassed in gas vans.”*

In addition to these show trials, Soviet prosecutor Smirnov presented the minutes of a Soviet court-martial – of all things – held on 29 October 1944, which claims the “annihilation of Soviet citizens in Smolensk in May 1943, by means of asphyxiation through carbon monoxide in gas vans.” The “information” gathered by Soviet court-martials was most certainly not more but rather less reliable than that gathered during the above-discussed Soviet show trials (vol. 7, p. 465). The attempt of defense lawyer Dr. Kurt Kauffmann to have this obvious propaganda material excluded failed, though, because Art. 21 of the London Charter defining the rules of the IMT stated clearly that all evidence created by the victorious powers has to be accepted at face value (vol. 1, p. 15), or in legalese expressed by the court’s presiding judge Lord Geoffrey Lawrence (vol. 7, p. 453):

*“Article 21 is perfectly clear, and it directs the Tribunal to take judicial notice of the various documents which are there set out, and expressly refers to the records and findings of military or other tribunals of any of the United Nations.”*

Other similar Soviet claims about “gas vans” were similarly based on the “findings” of investigations conducted by Soviet commissions (vol. 7, pp. 503, 544, 556, 571-575). In this context the Soviet prosecution quoted from a deposition allegedly made by a German soldier named E.M. Fenchel who is said to have been a PoW of the USSR. This deposition had been published in 1943 by the Soviet Embassy in the

U.S. as part of an already mentioned booklet consisting of crass anti-German atrocity propaganda. It is not known whether this person, whose name is spelled Fenichel in that brochure, ever existed.<sup>71</sup> If so, he was never presented as a witness during any postwar trial. The text contains interesting claims regarding the technical equipment of these vans (IMT, vol. 7, p. 572f.):

*“While working as a motor mechanic, I had the opportunity of studying in detail the van construction especially adopted for suffocating and exterminating people with exhaust gases. There were several such vans in the town of Stavropol at the disposal of the Gestapo.*

*Their construction was as follows: The body was approximately 5 meters long by 2½ meters wide by approximately 2½ meters in height. It was shaped like a railway car without windows. Inside it was lined with galvanized sheet iron; on the floor, also covered with galvanized iron, was a wooden grating. The door of the body was lined with rubber and was tightly closed with an automatic lock. On the floor of the van, under the grating, were two metal pipes. [...]*

*These pipes were connected with a transverse pipe of equal diameter. [...]*

*These pipes had frequent holes a half centimeter in width. From the transverse pipe down through a hole in the galvanized iron floor went a rubber hose with a hexagonal screw at the end, threaded so as to fit the thread on the end of the engine exhaust pipe. This hose is screwed on to the exhaust pipe and when the engine is running all the exhaust gas goes into the body of this hermetically closed van. From the accumulation of these gases, a man inside the van died within a short space of time. The machine could contain approximately 70 to 80 people. The motor of this machine usually bore the trademark ‘Sau[r]er.’”*

Saurer engines were always Diesel engines, so dying within a short period of time was not possible with such engines’ exhaust gases. If connected to the hot tail pipe, a rubber hose would not have lasted very long. A hermetically closed box would not have lasted long. The height of the vans’ cargo box, though needed to transport standing persons,

<sup>71</sup> Embassy 1943, p. 171; the same witness statement of a PoW Fenichel (without i) is quoted in an undated German translation of a report of the Soviet Extraordinary State Commission about German crimes allegedly committed in the Stavropol area: Gosudarstvennij Archiv Rossjskoj Federatsii (State Archive of the Russian Federation), ref. 7445-2-93, p. 24.

does not agree with the documented height of a mere 1.70 m. No rubber-lining of the door (what for? Or did he mean a rubber sealing?), automatic door (why and how?) are ever mentioned by other witnesses. As mentioned before (p. 118), the two parallel pipes connected with a transverse pipe and sporting numerous holes would have made no sense at all, other than being expensive and complex to install, complicating the cleaning of the cargo box, and making the entire system susceptible to damage. A thread could not be cut into a regular exhaust pipe, as they are usually too thin. Plus the extreme temperature differences of an exhaust pipe, coming with considerable thermal expansions and contractions, would have made it difficult to screw anything on it. No engineer would have resorted to such a solution.

Repeated references to the Becker letter and to the telegrams contained in 501-PS as discussed here in chapter 2.2.2. and 2.2.3. were meant to bolster the Soviet case (vol. 2, p. 126; 3: pp. 559-561, 4: pp. 213, 251, 253, 323f.; 7: pp. 172; 19: 511; 20: p. 177). One of the telegrams was again mentioned during the Einsatzgruppen Case of the NMTs (vol. 4, p. 514).

### 3.5.2. Walther Rauff's Affidavits

At war's end Walther Rauff was serving at the Italian front, where he was taken prisoner of war by U.S. troops in spring 1945. While imprisoned he was asked twice to confirm the authenticity of the Becker document, which was to be used as incriminating evidence against the defendants during the then pending Nuremberg Military Tribunal. On 18 October 1945 he wrote a handwritten note across the left margin of this document "confirming" its authenticity. On the next day he signed a brief English affidavit, in which he repeated this confirmation (IMT, vol. 30, pp. 256-258). Having a prisoner confirm the authenticity of a document before a trial is not necessarily common practice, but when considering the fact that the origin of the Becker document was noted as "unknown," one can understand the U.S. authorities' eagerness to have Rauff confirm its authenticity.

As Weckert has observed correctly (Weckert 2003, pp. 228f.), Rauff's affidavit contains a number of errors of fact, for instance that he wrongly located the Saurer company in Berlin, when in fact it was located in Vienna:

*"The vans were built by the Saurer Works, Germany, located, I believe, in Berlin."*

He may have confused Saurer with Berlin Gaubschat Company manufacturing the cargo box for these vehicles. Such minor mistakes would therefore not cast any doubt about the truthfulness of Rauff's affidavit. The orthodox Holocaust literature claims that Rauff had been in charge of deploying the "gas vans" ever since their inception (Kogon *et al.* 1993, pp. 53f.). All the more surprising it is to read that Rauff apparently didn't know much about those vans, which becomes apparent when he says for instance:

*"In so far as I can state these vans were probably operating in 1941."*

But the "gas vans" are not said to have been "invented" before the outbreak of war between Germany and the Soviet Union – Kogon *et al.* maintain that the gas vans were planned only in late 1941 (1993, p. 53), and according to the Just document they had been deployed starting in December 1941. Hence Rauff's statement doesn't make much sense.

Rauff also claimed that, after reading the Becker document, he had asked Pradel "to have the technical matters, of which the letters complained, remedied." Note the plural "letters"! Hence Becker wasn't just shown one letter, although he certified only the Becker document and doesn't mention any other document. Fact is that the Becker document does not contain any complaints about technical matters. Rauff's statement would make sense in the context of the Just document, though, which suggests numerous technical changes. This makes me suspect that Rauff had been shown that document as well. Why he wasn't asked to confirm the authenticity of the Just document as well is a mystery. Having been shown two such documents, which, superficially seen, seemed to mutually confirm each other, must have left an impression on Rauff. But since the Just document was never introduced during the IMT or the subsequent NMTs, maybe the issue of having its authenticity confirmed never came up.

Although the Becker document implied that Rauff was one of the main responsible persons in the deployment of the "gas vans" and as such "responsible for nearly 100,000 deaths during the Second World War,"<sup>72</sup> the U.S. troops did not transfer him to Germany for prosecution. Some time later Rauff actually even managed to escape from a U.S. internment camp and subsequently fled from one country to the next. He eventually emigrated to Chile, where he was interviewed at

---

<sup>72</sup> [http://en.wikipedia.org/wiki/Walter\\_Rauff](http://en.wikipedia.org/wiki/Walter_Rauff).

least twice, once by a journalist and once by a German public prosecutor.

The first interview was conducted by the U.S. journalist Georgie Anne Geyer, who met Rauff in southern Chile in 1966. Here are the relevant passages of what she claims Rauff had told her (Geyer 1966, pp. 109f.)

*“Then, in a conversation that kept changing from moment to moment, I decided to wade in – I asked him of what he was actually accused. His face tightened:*

*‘They say I killed ninety-six thousand Jews,’ he said unemotionally. ‘They know I never killed one man, and we never killed one Jew there.’ He paused. ‘That was [not] a gentleman’s war.’*

*‘There is no brief way to explain it all,’ he said as we drank a white Chilean wine. ‘Nobody can explain simply what happened in Germany. You have to understand what Germany went through in the twenties and thirties. It was a proud country, humiliated. No people can stand that. There were terrible things done, later on – I don’t say there weren’t terrible things. I’m not one who says he didn’t know...’ (He seemed, I thought here, almost strangely proud of not taking the ‘easy’ way out on ‘knowing.’) ‘I knew. But I was a soldier – right or wrong, my country. A soldier obeys. That’s what he is.’*

*I pressed him, because I still did not, then, know all the details of his case. ‘Of what exactly are you accused?’*

*‘They say that I was in charge of technical things,’ he said, his voice sinking lower. ‘What did I know of technical things? I was the organizer. Organization – that was my strength.’ [...].*

*As the corpulent hotelkeeper’s wife served us lamb from Tierra del Fuego, I asked him, ‘If you could go back, would you do the same thing over again?’*

*‘Yes,’ he said slowly, ‘I would have to say I would do the same thing again. There was nothing else to do.’”*

All we can deduce from these meager statements is that Rauff apparently had no bad conscience, that he felt innocent of the accusation of murdering 97,000 people, the figure given in the Just document (and not 96,000, as Rauff erroneously stated). Claiming that the Second World War was a “gentleman’s war” is surreal and contradicted by himself shortly thereafter when admitting that there “were terrible things done.” Hence I assume that this is a mistake in Geyer’s book.

Unfortunately Geyer did not dig deeper into Rauff's alleged knowledge of things.

Rauff was more specific about what he knew during an interview he volunteered to give to a German prosecutor on 28 June 1972.<sup>73</sup> Although most of the testimony is about competence issues in his former office at the RSHA – he describes himself again as having been a mere “mobilization organizer” (p. 8) – there are some devastating statements about the “final solution” from a man who was allegedly deeply involved in its implementation:

*“Of the measures against the Jews in Russia I knew right from the start. I never got to know officially, however, on what order the killing of the Jews was based. While I got to know after the war that there was a so-called Führer order, the content of which was the liquidation of the Jews for racial reasons, I cannot remember that during the war it had ever been said that there was such an order. Of the existence of such an order I should have been informed for my activity in Tunis, because there were many Jews there who even worked for us voluntarily without anything happening to them.*

*Already during the Polish campaign I had heard of liquidation measures against the Jews, without being still able today to say whether I got to know that officially in the course of meetings or from any conversations.”* (p. 8)

So here we have a person allegedly deeply involved in the organization of the mass murder of Jews, but he knows nothing of any orders to eliminate the Jews. In fact, his entire testimony is riddled with doubts and “I don't know anymore.” This emphasizes that Rauff could not distinguish anymore between what he knew back then and what he has “learned” ever since. Fact is, however, that, instead of him killing Jews, these Jews worked for him “voluntarily without anything happening to them.”

When asked more specifically about the “gas vans,” Rauff answered:

*“Regarding the annihilation of Jews in Russia I know that gas vans were used for this purpose. I cannot say, however, from when on and to what extent this happened. I used to think that the thing with the gas vans started at the time when I was at the navy. Today I have doubts about this and consider it possible that this matter only got going after I had returned from the navy. At any rate I know that*

<sup>73</sup> [www2.ca.nizkor.org/ftp.cgi/people/r/rauff.walter/Rauff-deposition-translation](http://www2.ca.nizkor.org/ftp.cgi/people/r/rauff.walter/Rauff-deposition-translation); page numbers of the interrogation protocol as rendered in this translation.

*at some time after my return I saw two of these gas vans standing in the yard, which Pradel showed to me. Somehow I then also learned that the gas vans were used for the execution of sentences and for the killing of Jews.*

*I consider it impossible that Pradel should have carried out the development of the gas vans on his own initiative. He must have received an order for this either from me or from another superior standing above me.*

*Whether at that time I had doubts against the use of gas vans I cannot say. The main issue for me at the time was that the shootings were a considerable burden for the men who were in charge thereof and that this burden was taken off them through the use of the gas vans.*

*I don't think that Dr. Siegert was involved in these matters at the time, although he probably knew about them.*

*It is correct that I received something from Becker about the use of gas vans. I myself had told Becker to send me a corresponding report." (p. 12)*

Excuse me? The person centrally responsible cannot remember how it came that these vans were used? And he only "somehow" – accidentally? – "learned that the gas vans were used for [...] the killing of Jews"? And as the one in charge of "mobilizing" the *Einsatzgruppen* and equipping them with vehicles, as the one who was allegedly involved in defining and improving the "gas vans" design, how come he was shown such a heinous vehicle only once in passing?

Since General Pinochet steadfastly refused to extradite him, Rauff had nothing to fear; hence he agreed voluntarily to testify in front of a German prosecutor. I therefore think that Rauff's statement is sincere and to the best of his knowledge. But all it proves is that he cannot distinguish anymore between what he knew then and what he learned later. However, if he had indeed been in charge of deploying these vans following extermination orders from higher up, then he most certainly would have remembered, or so I am inclined to think.

Rauff died on 14 May 1984 in Chile without ever having been prosecuted for his lack of knowledge about the crimes he is said to have committed.

### 3.5.3. Otto Ohlendorf's Affidavit and Testimonies

Ohlendorf had been the head of the security service (*Sicherheitsdienst*) within the SS-RSHA from 1939 to 1945. I subsequently quote from p. 3 of his affidavit dated 5 November 1945 (NMT, vol. 31, p. 41):

*"In the spring of 1942, we received ~~corpse~~<sup>gas</sup> vehicles from the Chief of the Security Police and the SD in Berlin. These vehicles were made available by office II of the RSHA. The man who was responsible for the cars of my Einsatzgruppe was Becker. We had received orders to use the cars for the killing of women and children. Whenever a unit had collected a sufficient number of victims, a car was sent for their liquidation. We also had these ~~corpse~~<sup>gas</sup> vehicles stationed in the neighborhood of the transit<sup>[74]</sup> camps into which the victims were brought. The victims were told that they would be resettled and had to climb into the vehicle for that purpose. After that the doors <sup>by starting the vehicle the gas streamed in</sup> were closed and ~~the gas turned on~~. The victims died within 10 to 15 minutes. The cars were then driven to the burial place, where the corpses were taken out and buried. [...]*

*I was shown the letter which Becker wrote to Rauff, the head of the Technical Department of office II, in regard to the use of these ~~corpse~~<sup>gas</sup> vehicles. I know both these men personally and am of the opinion that this letter is an authentic document."*

Ohlendorf's original testimony is extremely interesting, because in its original form he consistently used the term "*Totenwagen*" = corpse vehicle (or wagon for the dead). The "*Toten*" was later struck out and replaced by "*Gas*." The English translation of his testimony has no trace of this original wording.

Similarly revealing is the way Ohlendorf originally described the way the gas was administered ("*das Gas [wurde] angedreht*" = the gas [was] turned on). This was of course not in accordance with the official story of exhaust gases being piped into the cargo box, and so this passage, too, was changed later on.

<sup>74</sup> The official English translation in NMT 1950, vol. 4, pp. 206f., has the word "transient." This is no minor mistranslation, but reeks of fraud. Although the English terms could be confused (transient ↔ transit), the original German terms cannot (*Durchgangslager* ↔ *vorübergehende Lager*), and it is unlikely that the translator chose the false, but uncommon term (transient) by accident instead of the common, correct one, because the unwelcome term used by Ohlendorf here supports the revisionist theory that the alleged "extermination camps" were indeed mere transit camps.



Other than that we do not learn anything new about the deployment of the gas vans from Ohlendorf's declaration. It confirms the previously quoted witness testimony, according to which the van could operate ten to fifteen minutes. I maintain my claim that we deal with a technical impossibility: If the cargo box was hermetically sealed, then either the box would have burst or else the engine would have stalled.

Ohlendorf's testimony during the IMT regarding the gas vans basically repeated what he had already stated in his affidavit, but when asked "How was the gas turned on?," he revealed his lack of knowledge of any details about the issue: "I am not familiar with the technical details" (vol. 4, p. 322). This confirms that the original German version of Ohlendorf's affidavit probably conveyed what he had thought and that the correction was done by (or on command of) others. Also, his claim about how many persons were executed at one time (15 to 25, *ibid.*, p. 323) is at odds with the load usually claimed, which was three times as large. During his interrogation Ohlendorf was asked to authenticate the Becker document, which he did only in a roundabout way, and to retell the reasons why the gas vans were deployed, which is a leading question which in a proper court of law would have been forbidden, but in this case it indicates that Ohlendorf's testimony had been carefully choreographed (*ibid.*, p. 323f.).

Ohlendorf testified again during the *Einsatzgruppen* Case of the Nuremberg Military Tribunal. There he specified that there were two different sizes of gas vans, one for up to 15 people, and the other for up to 30. Amazingly, when asked whether the cargo box had any windows, he responded "That is possible" (NMT, vol. 4, p. 301), which once more proves that Ohlendorf was ignorant of the issue he was asked to testify about.

#### 3.5.4. Ernst Biberstein's Affidavit

Between September 1942 and June 1943 Biberstein was commander of *Einsatzkommando* 6. In his affidavit he writes regarding the deployment of gas vans (translation of document No-4314, NMT, vol. 4, p. 210):

*"I personally supervised an execution in Rostov which was performed by means of a gas truck. The persons destined for death [...] were loaded into the gas truck which held between 50 and 60 people. [...] I myself saw the unloading of the dead bodies, their faces were in no way distorted, death came to these people without any*

*outward signs of spasms. The gas truck was driven by the driver Sackenreuter of Nuernberg who had been most carefully instructed about the handling of the gas truck, having been through special training courses."*

While it is not likely that a commander of such a unit would waste his time by sitting in the passenger seat of such a van during its operation, it sure is possible. But a training course for gas van drivers? Are we to believe that Germany actually had special training courses for the teaching of gas van mass murderers?<sup>75</sup> Or is Biberstein here referring to the instruction of drivers in the handling of producer gas vehicles?

This brings up the issue on how the operators of these gas vans were instructed on how to use them. Maybe some secret courses to learn the trade existed indeed. But unless I find evidence for it, I decide *in dubio pro reo*.

### 3.5.5. Karl Braune's Testimony

Braune, head of *Einsatzkommando* 11b from October 1941 to October 1942, stated the following in his affidavit (translation of document NO-4234, NMT, vol. 4, p. 214):

*"In the spring of 1942 a gas truck was placed at the disposal of my unit, but I did not use it for executions. In my opinion an execution by shooting is more honorable for both parties than killing by means of a gas truck. This is the reason why I refused to use the gas truck."*

A brave and honorable act of inner resistance, bravo! And his superiors, allegedly always short of trucks to kill people, let him get away with having his gas van just sit there and rust?

### 3.5.6. Various Testimonies

I now turn to a number of statements by defendants at the IMT as well as their lawyers. First comes Baldur von Schirach, during the war head of the *Hitler-Jugend* and *Reichsstatthalter* in Vienna (vol. 14, p. 431):

*"Dr. Colin Ross came to Vienna in 1944 and told me that he had received information, via the foreign press, that mass murders of Jews had been perpetrated on a large scale in the East. I then at-*

---

<sup>75</sup> August Becker mentioned such training courses as well in 1960 (Beer 1987, p. 112).

*tempted to find out all I could. What I did discover was that in the Warthegau executions of Jews were carried out in gas vans."*

Unfortunately no one at the trial was interested to find out how and by which means von Schirach had found out what, as he was interrupted at that point, and the issue was not brought up anymore. The Chełmno camp is located in that Warthegau area, where mass murders with gas vans are claimed to have happened. I will return to this topic when dealing with the German postwar trials.

Alfred Jodl, at war's end chief of Staff of the supreme command of the German armed forces, stated the following (vol. 15, p. 333):

*"I never heard a single word about tortures, deported persons, or prisoners of war, crematoriums or gas vans, torments reminiscent of the Inquisition, and medical experiments."*

Although it might be that he had not heard of some of these things, he surely went too far when claiming that he had never heard anything about prisoners of war.

Hans Fritzsche, editor-in-chief of the German news agency "Deutsches Nachrichten-Büro" and Josef Goebbels' right-hand man, stated in his defense (vol. 17, p. 181):

*"I, as a journalist who worked during that period, am firmly convinced that the German people were unaware of the mass murders of the Jews and assertions to that effect were considered rumors; and reports which reached the German people from outside were officially denied again and again. As these documents are not in my possession, I cannot quote from memory individual cases of denial; but one case I do remember with particular clearness. That was the moment when the Russians, after they recaptured Kharkov, started legal proceedings during which killing by gas was mentioned for the first time.*

*I ran to Dr. Goebbels with these reports and asked him about the facts. He stated he would have the matter investigated and would discuss it with Himmler and with Hitler. The next day he sent me [a] notice of denial. This denial was not made public; and the reason stated was that in German legal proceedings it is necessary to state in a much plainer manner matters that need clarification. However, Dr. Goebbels explicitly informed me that the gas vans mentioned in the Russian legal proceeding were pure invention and that there was no actual proof to support it."*

Hans Laternser, defense lawyer of the Generals on trial, deliberated in his final plea (vol. 21, p. 402):

*“In the autumn of 1943, 195,000 persons are alleged to have been killed in mass executions and in gas vans in Kiev. For counter-evidence I refer to Affidavits 1116-a, 1116-b, and 1116-c, which show that the Wehrmacht never possessed any gas vans.”*

Has anyone ever heard about these affidavits? So far I have been unable to locate them. Since they are exonerating, they are probably considered irrelevant by orthodox historiography.

The same is true for 60 more such documents referred to by Hans Gawlik, defense lawyer of SS and SD defendants (vol. 22, p. 24):

*“The Prosecution have also submitted Document Number 501-PS on the use of gas vans. I must point out that Amt III never issued instructions on the use of gas vans, as testified by the witness Dr. Ehlich [vol. 42, p. 106]. Document 501-PS submitted by the Prosecution shows by its reference Number II that the matter of gas vans was dealt with in Amt II of the RSHA. The SS-Obersturmbannführer Rauff mentioned in the document was not a member of Amter III and VI, but a group chief in Amt II of the RSHA. He was at that time in charge of motor transport. I refer in this connection to the testimony of the witnesses Ohlendorf and Hoepfner (Session of 3 January 1946) and to 60 affidavits from the entire Reich and the occupied territories for the period from 1941 to 1945, according to which the SD had nothing to do with the use of gas vans.”*

There were a few other minor references to gas vans during the IMT, for instance the affidavit by Paul Blobel (3824-NO, NMT, vol. 4, p. 213). Where they contain any information about the gas vans, I have listed them in the appropriate sections of chapter 4.2.

### 3.5.7. Franz Ziereis’ “Confession”

On 8 April 1946 the former inmate of the concentration camp Mauthausen, Hans Maršálek, made a deposition for the Nuremberg Tribunal in which he claimed the following (IMT, vol. 33, pp. 279-286):

*“On 22 May 1945, the Commandant of the Concentration Camp Mauthausen, Franz Ziereis, was shot by American soldiers while escaping and was taken to the branch camp of Gusen. Franz Ziereis was interrogated by me in the presence of the Commander of the 11th Armored Division (American Armored Division) Seibel; the former prisoner and physician Dr. Koszeinski; and in the presence*

*of another Polish citizen, name unknown, for a period of six to eight hours. The interrogation was effected in the night from 22 May to 23 May 1945. Franz Ziereis was seriously wounded – his body had been penetrated by three bullets – and knew that he would die shortly and told me the following:” (p. 280)*

Before we turn to some excerpts of what Maršálek claims what Ziereis told him, we must pause for a moment and consider the situation: The former German camp commander Ziereis has been shot and is slowly bleeding to death. Yet instead of trying to save his life, they let him slowly die. In addition, the weak and dying Ziereis is being incessantly interrogated for hours on end through the night. This interrogation is not done by some neutral investigating person, but instead by three former inmates who must have had many axes to grind.

There is no signed and sworn “confession” by Ziereis. We only have Maršálek’s word for what Ziereis allegedly said, among which we find for instance:

*“Chemielskwy and Seidler in Gusen had human skin specially tanned on which there were tattoos. From this leather they had books bound, and they had lampshades and leather cases made.” (p. 281)*

After U.S. units had spread the atrocity story about lampshades and “leather” objects manufactured from the skin of murdered prisoners in the Buchenwald camp, Maršálek made sure “his” camp could compete with this by putting into Ziereis’ mouth a similar nonsense, for which there is not a shred of evidence.

*“According to an order by Himmler, I was to liquidate all prisoners on behalf of SS-Obergruppenfuehrer Dr. Kaltenbrunner; the prisoners were to be led into the tunnels of the factory Bergkristall and only one entrance was to be left open. Then this entrance was to be blown up by the use of explosives and the death of the prisoners was to be effected in this manner. I refused to carry out this order.” (ibid.)*

So wasn’t Ziereis a humane commander after all? The entire story is probably invented, though.

*“A gassing plant was built in Concentration Camp Mauthausen by order of the former garrison doctor, Dr. Krebsbach, camouflaged as a bathroom. Prisoners were gassed in this camouflaged bathroom.” (ibid.)*

I quoted this sentence in order to avoid accusations of omitting decisive passages. Since gas chamber claims are not a topic of this book, I merely want to point out that Austrian orthodox historians established in 1995 the complete lack of any traces of killing devices at the concentration camp Mauthausen. They also determined that the gas chamber shown to visitors in that camp is a post war fabrication with no relation to reality (Freund/Perz/Stuhlpfarrer 1995).

Immediately afterwards we find the following statement:

*“Apart from that a specially built automobile commuted between Mauthausen and Gusen, in which prisoners were gassed while travelling. The idea for the construction of this automobile was Dr. Wasiczki’s, SS-Untersturmfuehrer and pharmacist. I, myself, never put any gas into this automobile, I only drove it, but I knew that prisoners were being gassed.” (ibid.)*

This, too, is made up. If there ever were any “gas vans,” then they were the brainchild of people higher up in the hierarchy of the RSHA, like Walther Rauff. Apart, Rauff’s letter of 26 March 1942 (see Appendix 4), if dealing with “gas vans,” would be an indicator that the Mauthausen camp had requested such vans from the German Institute for Criminological Technology in Berlin. Hence no “gas vans” were ever invented by some little SS-Untersturmfuehrer personally known to Ziereis.

Ziereis’ claim to have driven the van himself is utterly unbelievable. The boss of a network of prison camps comprising 50,000 inmates and more – numerous “satellite labor camps” were also under Ziereis’ command – most certainly did *not* spend his precious time commuting in a van between two camps.

Furthermore the expression “I, myself, never put any gas into this automobile” indicates that those vans did not use their exhaust gas but required the addition of some other gas. This is probably the origin of the legend that some of these vans actually used Zyklon B to kill people. I will return to this claim in chapter 5.1., where I discuss claims made by French orthodox historian Pierre-Serge Choumoff about Mauthausen.

At the end of his “confession” Ziereis is said to have claimed the following:

*“SS-Gruppenfuehrer Gluecks gave the order to classify weak prisoners as mentally deranged and to kill them by a gas plant which*

*existed in the Castle Hartheim near Linz. There, about 1 - 1½ million human beings were killed.*" (p. 282)

Even orthodox historians agree that such a gargantuan number of victims is nonsense, plain and simple. If Ziereis said something like it, it merely proves the methods used to extract this statement. Maršálek himself must have been aware of the incredibility of this victim count, so he tried to shore it up by stating at the end of his testimony:

*"He [Ziereis] however insisted on this number and explained to me that actually a great number of mentally deranged from the entire Southern Area of Germany were shipped there and liquidated. This accounts for the high number of victims."* (p. 285)

Sure.

Ingrid Weckert pointed out (2003, p. 220) that Maršálek has changed his story in the second edition of his books about the history of the Mauthausen camp. Regarding the death of Ziereis he writes there (1980, p. 200, note 15):

*"On May 23, 1945, Ziereis was apprehended in his hunting cabin on the Phyrn (upper Austria) by American soldiers, and was injured by two bullets when he attempted to flee. As a result of these injuries Ziereis died on May 25, 1945, in the 131st American Evacuation Hospital, Gusen."*

In this book Maršálek makes no reference to any interrogation of Ziereis, which according to his affidavit of 1946 would have taken place the night *before* Ziereis' discovery and arrest. Maršálek even explains in his preface why he has omitted this affidavit:

*"Further, all statements that cannot be documented [...] have been deleted."*

### 3.5.8. A Special Murder Vehicle

A special case of murder vehicle is described in two German documents which entered the Nuremberg files as 4048-PS (IMT, vol. 34, pp. 125-128; cf. vol. 20, pp. 151f.).<sup>76</sup> They describe a German plot to assassinate French General Deboisse held as a PoW in late 1944. The second of these documents written by Kaltenbrunner and sent to Himmler states succinctly:

---

<sup>76</sup> The German "Kohlenoxid" = carbon (mon)oxide has been mistranslated as carbon dioxide in the English translation.

*“Carbon monoxide is released by the driver into the closed back of the car. The apparatus can be installed with the simplest means and can be removed again immediately. After considerable difficulties a suitable vehicle has now become available.”*

From the proceedings themselves it can be gleaned that Deboisse was indeed assassinated (vol. 21, p. 501), but it is unclear by which means, as two more options (shooting, poison) were laid out in these documents. I am quoting this document in order to highlight that the German authorities considering this assassination did not plan to pipe exhaust gases into the passenger compartment, but rather to use a separate device, probably bottled pure, odorless CO gas. Anything else would have been technically too complicated, plus it would have caused the intended victim to become suspicious and cause trouble.

Himmler, of course, would also have been the driving force behind the “gas van” mass murders in Eastern Europe. If these mass murders had taken place in the preceding years, wouldn’t the masterminds of this crime have thought similarly then and employed something more suitable than hardly toxic, but highly irritating Diesel fumes?

### 3.6. Gas Vans during Postwar Trials Outside of Germany

#### 3.6.1. Yugoslavia

In 2010 Byford published a critical study about gas van claims made by the Yugoslavian judiciary after the war. Since his critical method of assessing witness statements is of central importance to the present study, I will abstain from reinventing the wheel and direct the reader’s attention to Byford’s paper as well as my remarks about it in chapter 4.1.

I want to indicate here, though, that one witness about the Semlin camp near Belgrade testified that the Jews there were killed by all kinds of means, among them *not* a gas van but a gas chamber. This account was mentioned during the Eichmann trial in Jerusalem (State of Israel 1993, session 46, part 6; 19 May 1961):

*“I know that part of [the Jews...] were suffocated in gas chambers.”*



Even though prosecutor Bar-Or tried to repair this damaging testimony by stating that this “is not a reference to gas chambers,” since we “know from other evidence that gas vans were sent to Serbia,” but that does not change the fact that with this statement the divergence of witness accounts on those alleged gas vans received yet another – stationary – dimension.

### 3.6.2. Poland

#### 3.6.2.1. General Remarks

The Polish trials against Germans during the immediate postwar time are infamous for their Stalinist character. They were prepared and conducted during a time when Poland had not only been forcibly turned into a Stalinist state due to its occupation by the Red Army, but in addition it was dominated by a rabid anti-Germanism which in those years had turned genocidal, manifested by the greatest ethnic cleansing the world has ever seen (de Zayas 1993) and by extermination camps into which German civilians were pressed and subjected to a cruel regiment leading to the death of many thousand inmates (Sack 1993). In those years Poland desperately needed a reason to “justify” its unfolding genocide and a tool with which to secure for the future its robbery of 20% of Germany’s territories. The Stalinist show trials staged after the war were the vehicles with which this goal was to be achieved. They were charged with producing the evidence of an unprecedented genocide committed by Germans on Polish soil, which was to justify or at least make understandable any anti-German measure after the war. While the IMT and the NMTs only scratched the surface by making mainly unsubstantiated claims about the alleged genocide committed by the Germans during the war, the Polish judiciary subsequently set out to fill in the framework given by the Allied tribunals.

The most prominent of these trials is the Krakow trial against the guards of the former German concentration camp at Auschwitz. Matogno has thoroughly documented (2010), how the extant German war-time documents were twisted and maliciously misrepresented by the court in order to form a base upon which, with the help of mendacious witness statements and coerced confessions, the legend of the extermination camp was erected, which to this day forms Poland’s, if not the world’s stranglehold on Germany’s (and Austria’s) self-perception.

The same methods were of course also applied by the Stalinist Polish postwar judiciary during other trials against Germans. Although this is not to say that Germans did not commit crimes during the war in Poland, this nevertheless needs to be kept in mind when looking into these court cases.

### 3.6.2.2. The Cases against Piller and Gielow

According to my knowledge, two trials were conducted in Poland shortly after the war in which gas vans played a role. The only information I could come by so far I have found in the chapter on the Kulmhof/Chełmno camp of Kogon *et al.*, who quote frequently from witness statements contained in the trial records of these trials, one of which had been conducted in Łódź, the other in Kalisz (court file dates 1947 and 1948, respectively; Kogon *et al.* 1993, fn 6, 10, 13, 17-19, 35, 37, 39, 41-43, pp. 262f.). The remaining quotes of that chapter refer almost exclusively to the court records of the Bonn trial against the Chełmno guards, which I will address in chapter 3.7.4.1.

Kogon *et al.* quote a “confession” made by Walter Burmeister after the war in Poland about the deployment of gas vans in Chełmno. He describes them just as they appear in the extant authentic correspondence between the RSHA and the Gaubschat company, yet instead of a simple hole in the floor through which the gas was piped, he claimed in deviation from the standard version that underneath the obligatory wooden floor grate there was a “pipe, pierced with holes, which led out to the front,” where a “metal spiral hose” was attached in order to pipe exhaust gases into the cargo box. Burmeister insisted with resolve, however, that the vehicles were “medium-weight Renault trucks with Otto engine,” which had been “difficult to drive” (Kogon *et al.* 1993, p. 77). However, there is no documentary or anecdotal evidence that a Renault truck was ever used by the RSHA for anything, let alone as a gas van equipped as described by Burmeister. They are all supposed to have been Diamond or Saurer trucks. This indicates that Burmeister was merely parroting what the Poles put on his platter, and he added his own yarn, which reveals the worthlessness of his statement.

It is worth noting that, during an interrogation some 15 years later in Germany on January 24, 1961, Burmeister described the piping device differently, this time strictly following the version claimed by the Becker and Just letters (Klee/Dreßen/Rieß 1988, p. 202):

*“The gas van was a large truck with a ca. 4 to 5 m long, ca. 2.20 m wide, and 2 m high cargo box. It was lined with sheet metal on the inside. There was a wooden grate on the floor. There was a hole in the floor of the cargo box which could be connected to the exhaust pipe with a flexible metal hose.”*

Hence Burmeister’s knowledge had been “streamlined” over the years to fit the orthodox “truth.”

Another “confession” from the Polish files stems from Walter Piller, the former deputy commander of the Chelmno camp. When he penned down this text in May 1945, he was a PoW in the custody of the Soviet Union. So here we have a direct documentary link between the Stalinist wartime show trial in the Soviet Union and its copycat version in Poland after the war. Kogon reproduces large parts of this piece of Soviet war propaganda (*ibid.*, pp. 95-99). Since Mattogno has dealt with Piller’s “confession” in detail (2011a, chapter 7.1.), I will restrict myself to the passages dealing with gas vans (*ibid.*, p. 98):

*“At the end of this ramp was a closed truck into which the Jews had to climb. When seventy or ninety people were inside, the doors were closed and the van drove the two hundred–odd meters to the crematory ovens. On the way, Laabs, the driver, opened a valve through which gas flowed. The occupants died within two to three minutes. The gas used was produced by the gasoline engine.”*

If the deputy camp commander didn’t know, who would have? The story about the valve in the driver’s cabin and the swift execution within 2 to 3 minutes sticks out of the mass of witness accounts like a sore thumb. Soviet war propaganda, as I said. An interesting aspect is the gasoline engine, whose exhaust gases would have been suitable to kill, although hardly within three minutes after opening “the valve.” Considering that the Soviets insisted on a Diesel engine as a source of the exhaust gas still during the IMT, it is unlikely that this version came from there. On the other hand, the German word for gasoline (*Benzin*) is frequently used by people unfamiliar with technical issues to describe the fuel for any kind of internal combustion engine.

The affidavits by various witnesses compiled in preparation of these trials will be discussed in detail in the next four subchapters.

### 3.6.2.3. The Interrogation of Bronisław Falborski

Appendix 9 contains a reproduction of the original as well as a translation of the “Protocol of the interrogation of a witness,” which took

place on 11 June 1945 in Koło (Poland).<sup>77</sup> In it Falborski claimed to have repaired a truck he considered to have been a “gas van.” He described it with no great details as a black truck with a cuboid cargo box. He stated that he “had the impression that there were only two” of these trucks driving forth and back between the Chełmno castle and a forest where, according to other witnesses, the mass graves of the gassing victims are said to have been located.

Right after this statement Falborski says:

*“Three times I saw a converted moving truck van which is currently in the courtyard of the former ‘Ostrowski’ company. Once I had already seen this vehicle in the forest, the second time on the road and the third time when it was just coming out of the courtyard of the Chełmno castle.”*

With this Falborski suggests that the Ostrowski Magirus was either identical with one of the two trucks mentioned by himself which were allegedly shuttling forth and back from the castle to the forest, or he implies that this moving truck was a third vehicle repeatedly making the same tour. At any rate, this links this vehicle to the alleged gassings in the eyes of this witness.

Since the Polish investigation commission came to the conclusion that this truck had indeed been nothing else but an innocuous moving truck (see chapter 2.1.), it can therefore be stated with certainty that the witness Bronisław Falborski did see nothing else but a harmless moving truck driving about, and subsequently also that the other trucks driving along the same route were on similarly innocuous missions.

So how do we assess Falborski’s description of the repairs he claims to have made on an exhaust system of a truck with apparently homicidal features? The answer to this question lies hidden in the witness’s testimony. If we carefully analyze what he tells us about the exhaust system he claims to have repaired, it turns out to be nonsensical:

a) Large trucks do not have tail pipes reaching all the way to the end of their cargo compartment. Their exhaust pipes exit either overhead of the driver’s cabin or on the left side behind the driver’s cabin. The reason for this is that the engines of such trucks are always in front of or underneath the driver’s cabin, and adding useless five meters of exhaust pipe to reach the truck’s end would be a crazy waste of material and would be asking for trouble.

---

<sup>77</sup> Copy and German translation in ZStL ref. 203 AR-Z 69/59, special binder A; also in Bednarz 1946c, pp. 28f.

b) There is no other witness testimony confirming the complicated nature of the system as described here (although there are other statements claiming other nonsensical setups, as we will see later).

c) The witness contradicts himself. First he says that the exhaust system allegedly used to perform homicides consisted of three parts: the fixed front part of the exhaust pipe, a fixed part leading into the cargo box, and a flexible part connecting the two



**Illustration 5:** Bronisław Falborski in Lanzmann's movie *Shoah* (1985)

("that the exhaust pipe [...] consist[ed...] of three parts"). This is logical. But then he claims that there was another, fourth part between the flexible middle piece and the pipe penetrating the cargo box's floor: "the middle part of the pipe was connected with the interior of the vehicle, but the part between these two parts was worn." This was the very piece he claims to have replaced. Such a piece is nonsensical and most certainly did never exist, even if the rest of his story were true. The witness just made it up in order to have something to replace, that is to say, in order to be able to make up a tall tale.

The drawings added by the witness confirm our impression; they are of a very bad quality and rather puerile, more able to obfuscate the matter than to clarify anything. The upper drawing allegedly represents the truck. The lower sketch consists of two drawings: on the left something resembling two pipes connected by a flange, and on the right a square with four dots, apparently showing a plan view of the flange, although interestingly it does not include the central opening for the pipe. Hence this Polish mechanic must have been a really bad draughtsman.

Using a flange rather than a clip to attach the flexible hose to the pipe was an awkward solution, as any change from "gassing" to normal operation and *vice versa*, would have necessitated the opening of the flange, which was a rather laborious procedure.

Another surprising aspect of this testimony is that the Germans, who are said to have perpetrated their extermination operations under the strictest secrecy, let a Polish mechanic do this trivial repair of a gas van,

allowing him to recognize its murderous nature – all the more so since the exhaust system was still in the “homicidal” position when handed in – and who must have been expected to convey this information to his compatriots. Apart from Falborski himself, seven more individuals are said to have worked in the same workshop where the repair work was done, whose names as given by Falborski indicate that they, too, were Poles. Although the witness claims that the German police did not allow the workers to investigate the design of the vehicle, this is a ridiculous claim, as the mere fact that the exhaust pipe led straight into the cargo box was sufficient proof that the vehicle was meant to be used for murderous ends, a fact which could not have evaded Falborski’s and his colleagues’ attention.

In summary, it is clear that this witness statement was meant to corroborate the intended claim by the Polish Investigative Commission that the moving truck found by them in the courtyard of the former “Ostrowski” company in Koło, Poland, had been a homicidal “gas van.” It is fortunate that at the end of the day this Commission and even the Polish prosecutor were honest enough to admit that this truck never served any homicidal purposes. However, by so doing they proved that witness testimonies given in front of judges or prosecutors in Stalinist postwar Poland did not always tell what they knew but rather what they were told to know.

Falborski also featured in Claude Lanzmann’s movie *Shoah* (1985). While right after the war the only knowledge he claimed to have about gas vans came from what he had allegedly observed while repairing one, plus that he had seen these vans on occasion on the roads, in Lanzmann’s movie he suddenly had detailed knowledge about their operation, even about the entire program of exterminating the regional Jews.<sup>78</sup>

*“Were there a lot of Jews in Koło?”*

*‘A great many. More Jews than Poles.’*

*‘And what happened with the Koło Jews? Was he an eye-witness?’*

*‘Yes. It was frightful. Frightful to see. Even the Germans hid, they couldn’t see that. When the Jews were herded to the station, they were beaten, some were even killed. A cart followed the convoy to pick up the corpses.’*

---

<sup>78</sup> [www.youtube.com/watch?v=ZPQ9jYe\\_7HY;\\_lFfAH3BA04;R6nvodrL7Qo](http://www.youtube.com/watch?v=ZPQ9jYe_7HY;_lFfAH3BA04;R6nvodrL7Qo).

*'Those who couldn't walk, were slain?'*

*'Yes, those who'd fallen.'*

*'Where did this happen?'*

*'The Jews were collected in the Kolo synagogue. Then they were herded to the station, where the narrow-gauge railroad went to Chelmno.'*

*'It happened to all the Jews in the area, not just in Kolo?'*

*'Absolutely. Everywhere. Jews were also murdered in the forests near Kalisz, not far from here.'* [...]

*'Was the road between Chelmno, the village and the woods where the pits were asphalted as it is now?'*

*'The road was narrower then, but it was asphalted.'*

*'How many feet were the pits from the road?'*

*'They were around 1,600 feet, maybe 1,900 or 2,000 feet away. So even from the road, you couldn't see them.'*

*'How fast did the vans go?'*

*'At moderate speed, kind of slow. It was a calculated speed because they had to kill the people inside on the way. When they went too fast, the people weren't quite dead on arrival in the woods. By going slower, they had time to kill the people inside. Once a van skidded on a curve. Half an hour later, I arrived at the hut of a forest warden named Sendjak.<sup>[79]</sup> He told me: 'Too bad you were late. You could have seen a van that skidded. The rear of the van opened, and the Jews fell out on the road. They were still alive. Seeing those Jews crawling, a Gestapo man took out his revolver and shot them. He finished them all off. Then they brought Jews who were working in the woods. They righted the van, and put the bodies back inside.'"*

30 some odd years after the war Falborski had obviously enhanced his memory with what he had heard since the war's end. I also wonder if by then Falborski had knowledge about the Becker document talking about the gas vans skidding about.

Stories from hearsay related some forty years after the alleged event are notoriously unreliable. In order to proof this, let's imagine this scene described in detail by Falborski at the end of the above quote. According to orthodox historiography, between 50 and 100 people were crammed into these trucks. The truck was operated by one or two men, and it was only occasionally accompanied by a car with one or two

---

<sup>79</sup> In 1945 his name had been Maj, see Appendix 9.

more German officials. So let's assume in this case we had "only" 50 victims plus a car as an escort. The truck skidded and turned over. The doors burst open, and 50 Jews came tumbling out still alive. Four German officials now faced 50 Jews somewhere in a forest. One of the Germans decided to shoot them all. So he pulled out his Walther P38, the German standard army pistol – which was carried only by officers, but not by rank and file soldiers. This weapon can hold 8 rounds.<sup>80</sup> Since the Germans did most certainly not send four officers on this gassing tour, the one person having a pistol could not fall back on the other Germans' ammunition. Hence, if assuming that this German officer needed only one bullet for each victim – a conservative assumption – then this German fiend had to reload his pistol (50/8) seven times. It is neither likely that he carried seven full cartridges in his pocket, nor is it likely that he had 42 loose rounds. So how did he get the ammunition needed? And while shooting the first Jew, what was the reaction of the other 49 Jews? Would they have patiently waited for their turn? And after he had emptied his first cartridge and was trying to reload his pistol or radioed to his head office for support and more ammunition, what were the remaining 42 Jews doing? Sitting down and waiting?

Hence we have caught Falborski lying twice. It seems that each time he talks about the "gas vans," he is lying.

It is interesting to note that other Poles who worked together with Falborski at that auto repair shop testified as well, as Falborski himself mentioned.<sup>81</sup> They all described various aspects of the vehicle(s) they had seen and worked on and agreed more or less about what they claim to have seen. The witnesses Jozef Piaskowski and Bronisław Mańkowski allegedly even confirmed the awkward, nonsensical setup of the alleged exhaust system.<sup>82</sup> I will spare the reader any more details here and refer to these testimonies instead. Equipped with the critical faculties developed above, the inclined reader will be able to see through these streamlined, orchestrated testimonies without my guidance.

Before leaving this witness and turning to the next witness who testified before the same Polish judge, I would like to draw attention to the testimony of a German witness made some 16 years later containing a detailed description of the exhaust system he claims to have seen. It was

---

<sup>80</sup> [http://de.wikipedia.org/wiki/Walther\\_P38](http://de.wikipedia.org/wiki/Walther_P38).

<sup>81</sup> See chapter 3.6.2.7. for more details.

<sup>82</sup> Acc. to Halbersztadt, see footnote 26.



Johann Haßler who stated that he had driven a “gas van” (Kohl 2003, pp. 69f.):

*“At the exhaust pipe, right after the engine, there was a short connecting piece with a thread. Onto this thread a metal hose could be screwed, which led into the interior of the box. Behind the connecting piece was a slider, which closed the exhaust pipe opening to the rear so that the gases were now piped into the interior of the box. There two pipes branched off to both sides, and they ran along the sides of the box floor. The box floor itself was covered by a wooden grate so that the pipes could not be seen. The pipes had a hole of some 1 cm diameter each 4 cm. Exhaust gas was flowing in through these holes when the engine was running.*

*This vehicle was an American 3 ton truck of the make Diamond. Only the chassis and the engine were from that company, though. It had a wooden box-like coachwork measuring 3.5 × 2.5 × 2 m. On the inside it was lined with metal sheets. The vehicle had a dark grey color. It has no windows and had double doors at its back.*

*Unterscharführer Hans Meyerhoff was the co-driver. During the latter deployments of the gas van he operated the gassing device while I merely drove. Operating the gassing device was very easy: A hose had to be connected to the connecting piece, and the slider at the exhaust pipe had to be closed.*

*This was about the gassing of Jews in Minsk [...]. Each gas van could accommodate some 25 persons. [...] This way the gas vans stood side by side some two meters away from the edge of the pit, when the order was issued to let the engines run. Shortly before this the co-driver had connected the metal hose and had closed the slider behind the connecting piece. [...] the engines ran for some ten minutes. After waiting some more ten minutes, the co-driver had to open the doors, and the captive Russians [POWs] had to pull the dead Jews out of the vehicle and throw them into the pit.”*

The exhaust system described here is completely different than what Falborski has described. One may try to explain them away by saying either that Falborski was obviously not inclined to tell the truth anyway or that both witnesses simply had seen different vehicle types.

The problem is more profound, though. Exhaust pipes are not thick pipes allowing the easy addition by welding of thick, threaded pipe pieces forking off to allow a hose to be screwed onto it. The damage

done to the exhaust pipe would probably have been bigger than the functionality gained – but was any functionality gained at all?

Adding a slider to close the rear part of the exhaust pipe sounds easy enough, but that is far from true. The slider had to be held in place by something and at once be able to close the pipe completely. Hence this would have required cutting a piece out of the exhaust pipe and inserting some device that could accommodate the slider. That would have made sense only, if one insisted on leaving the metal hose leading into the box's interior connected at all times. If it was added only during a gassing, as the witness claimed, it could just as well have been stuck (or screwed) onto the end of the exhaust pipe. So there was really absolutely no point for such a messy, complex remodeling of the exhaust pipe. It can safely be assumed that the witness made it up.

Another remarkable feature attested to by the witness are the two pipes branching off inside the cargo box to both sides, running “along the sides of the box floor.” Giving such a meticulous description of a sophisticated detail might make the testimony more credible in the eyes of the read, but at closer inspection the opposite turns out to be true.

It may be assumed that the witness implied that these pipes were meant to serve the even distribution of the gas inside the van close to the floor (comparable to the burner of a gas stove). Such a system seems reasonable at first sight, but as I have described before (pp. 118, 130), this is far from true. I may elaborate on this a little more here, even if it appears repetitive. Since the exhaust gases would have streamed into the cargo box with considerable speed and since the victims, through their body motions and breathing, would have caused sufficient air motion in the van to further distribute and mix the gases, a sophisticated gas distribution pipework was utterly unnecessary. It would only have complicated the manufacture and maintenance of these alleged vans. As a matter of fact, cleaning the van equipped with such pipes would have been difficult, and the pipes would have been in constant acute danger of being damaged by the cleaning personnel. The existence of such a pipework is moreover contradicted by the Just document (if one is inclined to take it seriously), which in its third paragraph suggests the upward relocation of the intake pipe (for the gas) so that no fluids can enter into the opening. If it existed in the first place, it can be concluded from this that the gas intake consisted of a mere opening in the floor.

Hence this detailed description of something that no reasonable engineer or mechanic with some common sense would have ever seriously considered installing proves merely that the witness's fantasy was running rampant.

In passing I may note that in a 1961 testimony a certain Erich G. stated that he, too, drove such an alleged gas van in the Minsk area, but according to him the vans could hold 50 to 60 people, and he merely talked about him "connecting the hose to the exhaust pipe" without referring to any fanciful yet useless contraption. (Benz/Distel 2009, pp. 575f.)

#### 3.6.2.4. The Interrogation of Szymon Srebrnik

This witness, who at the time of his interrogation was only 15 years old, is said to have been one of only three survivors of the Chełmno death camp ever to testify about what had transpired there.<sup>83</sup> On 29 June 1945 he testified before the Examining Judge Władysław Bednarz as follows (Srebrnik 1945):

*"There were three vans: [a] larger one and two smaller ones. The larger van could hold up to 170 people, while the smaller ones, 100-120."*

With this size the witness sets the record for the vans' capacity and goes well beyond what would have been physically possible even with the large Saurer trucks. The witness continues:

*"The van doors were locked with a bolt and a padlock. Then the engine was started. The exhaust fumes entered the interior of the van and suffocated those inside. The exhaust pipe went from the engine along the chassis and into the van, through a hole in the car's floor, which was covered with a perforated sheet of metal.*

*The hole was located more or less in the middle of the chassis. The van's floor was also covered with a wooden grate, just like the one in the bathhouse. This was to prevent the prisoners from clogging the exhaust pipe.*

*The vehicles were specially adapted vans. On one of them, under a new coat of paint, one could see a trade name. I cannot remember the name, but it started with the word 'Otto.'*

*I do not know the make of the engine. The chauffeurs were Burstinger [Burmeister?], Laabs and Gielov. Shouting and banging on*

<sup>83</sup> State of Israel 1993, vol. III, p. 1194, right after the witness Żurawski had been dismissed; online: .../Session-065-06.html, end of text; cf. Kogon *et al.* 1983, p. 145.

*the door lasted about four minutes. The van was not moving at that time.*

*After the shouting faded, the vehicle started moving in the direction of the crematoriums. When the van reached its destination, its door was unlocked to let the fumes out. Then two Jews went inside and threw out the bodies.*

*The gas coming out had all the characteristics of the exhaust fumes (colour and smell) I cannot be mistaken here. The corpses, having been searched through, were placed in the furnace. [...]*

Note that exhaust gases from gasoline engines would not have any distinct, perspicuous characteristics, hence this statement indicates the use of Diesel engines. As to the “trade name” referred to as ‘Otto,’ he specifies a little later:

*“(Here, the witness was shown a van found in the Ostrowski’s factory in Kolo). This is the van used in Chelmno for gassing. This is the vehicle I mentioned in my testimony with the word ‘Otto’ on its door.”*

As mentioned in chapter 2.1., the moving truck found in Kolo was formerly owned by the moving company “Otto Koehn Spedition.” Like Falborski, this witness as well confirms the identity of his “gas van,” which was no gas van at all. It shows that his statement, too, was orchestrated. That the witness is telling invented nonsense can be seen from the following statement:

*“There were a few instances of unintended self-incineration: a Jew trying to set fire to a pile of bodies died in the flames himself.”*

As if humans can suddenly catch fire when exposed to flame and die in it.

At the end of his statement, when telling the tall tale of his escape, the witness recounts yet another nonsensical story:

*“Lenz ordered us to lie down on the ground. He shot everybody in the back of the head. I lost consciousness and regained it when there was no one around.*

*All the SS men were shooting inside the granary. I crawled to the car lighting the spot and broke both headlights. Under the cover of darkness I managed to run away. The wound was not deadly. The bullet went through the neck and mouth and pierced the nose and then went out.”*

A miracle, indeed! How much the statements of the witnesses interrogated by Bednarz had been streamlined due to cross-fertilization can

be derived from the fact that the peasant Andrzej Mischczak, who had lived close to the Chełmno camp, could accurately re-tell Srebrnik's miraculous survival story (Bednarz 1946c, p. 52f.):

*“Apart from Żurawski maybe also the Jew Simon Srebrnik was rescued, who got shot in the back of the head by the Germans, thus killing him, or so they thought. But the wound wasn't lethal, and Srebrnik survived.”*

And here is yet another dramatic atrocity story by Srebrnik, which I refuse to believe, but the reader may disagree with me here:

*“Finkelstein, whom I have already mentioned in my testimony, had to throw his own sister into [the] flames. She regained consciousness and shouted, ‘You murderer, why are you throwing me into the furnace? I'm still alive.’”*



**Illustration 6:** Michał Podchlebnik (Bednarz 1946c, Illustration p. 10)

### 3.6.2.5. The Interrogation of Michał Podchlebnik

This witness is said to have been the second of three survivors of the Chełmno death camp. In his interrogation of 9 June 1945 before investigative judge Bednarz, Podchlebnik claims to have merely heard how the gassing procedure in Chełmno was carried out (Podchlebnik 1945):

*“Suddenly, I heard a truck door slam followed by an outburst of screaming and banging on the truck's walls. Then I heard the engine start and after six-seven minutes, when the screams faded and died, the truck left the palace grounds. Next we were ordered to go to a large room upstairs.”*

Why the persons herded into the van would suddenly start to scream after the door had been shut is a mystery. Here, too, the gassings are said to have been committed while the truck was stationary, a procedure conducive only for vehicles with gasoline engines.

The witness's next statement is a story he heard from other inmates who had allegedly unloaded the vans, hence this is from hearsay:

*“They removed the corpses from large black vans, in which according to their accounts, Jews had been poisoned with exhaust fumes.”*

*The corpses were in underwear, in the van there were some towels and pieces of soap [...].”*

Later the witness states that he had to remove “towels and pieces of soap” from the van after the gassing in order to reuse them. This procedure is said to have been meant to fool the victims into believing that they were going to take a shower. People struggling for their lives would have made a mess of both towels and soap, though, so such a procedure sounds far-fetched.<sup>84</sup>

*“The following day I volunteered to work in the woods.*

*While I was leaving, I saw a large van with its back end up against the palace. The door was open. A footbridge made it easier to get into the vehicle. What drew my attention was a wooden grate on the van floor, just like those in a bathhouse. [...]*

*At about 8am the first car from Chełmno arrived. When the van’s door was opened, dark smoke with a white tint belched out from the inside. We were not allowed to approach the van at that moment and could not even look in the direction of the open door.”*

How did he manage to see the smoke then? Interestingly, lethal gasoline engines do not produce dense smoke, and smoking Diesel engines are hardly lethal, most certainly not for those opening the door.

*“I noticed that the Germans, having opened the door, ran away from the vehicle. I cannot tell whether the gas coming out from the inside was an exhaust gas or some other gases. We usually had to wait for so long that I did not smell the gas. Gas masks were not used.*

*After three or four minutes had passed three Jews went into the van.”*

Quite a theatric scene, but completely made up. No matter what engine these vans had, there was no reason at all to run away. Apart from which, if the Germans thought they had to run away from the vehicle, why were they near it in the first place, and if they ran, why didn’t the Jews run with them and keep running? After all, running Germans are pretty bad guards...

*“The corpses generally did not look bad. I did not notice anyone with their tongue sticking out of their mouths or with any unnatural bruises.”*

---

<sup>84</sup> In his testimony before a Polish judge, former Chełmno inmate Bruno Israel also claimed that the victims led into a gas van in Chełmno were given soap, unless they had their own. Towels, they were told, would be issued at the bath (Bednarz 1946c, p. 70).

That's not along the line of many other witnesses, but is not really indicative of anything.

*"I could not smell any gas."*

If the van had been filled with clearly visible smoke, after a few minutes of venting the exhaust gasses inside the van would still have been noticeable. Maybe the witness involuntarily tells us here indirectly that these corpses were *not* the results of gassings?

*"After the van had been emptied of the bodies, it returned to Chelmno. Two Jews passed the corpses to two 'Ukrainians' whose names I do not know. They spoke Polish and wore civilian clothes.*

*There was one more 'Ukrainian,' but he was accidentally trapped in the van and gassed along with other Jews. They tried to rescue him by artificial respiration, but the attempt was unsuccessful. I was there and saw it myself."*

This is yet another dramatic scene, which required that this poor Ukrainian fellow had entered the van with the Jews during loading at Chelmno. How one can accidentally be gassed that way was apparently incomprehensible even to the interrogating judge, leading to the witness's emphasis:

*"I was there and saw it myself."*

Here again the already referred to Polish peasant Andrzej Miszczak, a mere resident in the vicinity (p. 156), delivers us "converging proof" – not necessarily for the reality of this event, but merely for the cross-fertilization among these witnesses interrogated in Poland right after the war (Bednarz 1946c, p. 49):

*"The eighth Pole [of the Chelmno gassing Sonderkommando] was 'Marian' who accidentally got into the vehicle and was poisoned. This was during the first days of January.*

*In 1942 he was buried separately on the castle grounds."*

The evil Ukrainians, diabolical lackeys of the Germans, were used for all sort of vile jobs to desecrate and plunder the victims. Here some Holo-pornographic scenes:

*"The 'Ukrainians' pulled out gold teeth from the corpses' mouth, tore off little sacks of money from their necks, pulled off wedding rings, watches and so on. The corpses were searched over very precisely. The 'Ukrainians' were looking for gold and valuables even in women's reproductive organs and anuses. They did not use rubber gloves."*

About the gas vans, Podchlebnik says only the following:

*“The van in which the victims were gassed could take 80-90 people at a time. During my stay in Chelĵmno, two cars were used simultaneously. In addition, there was another van, the largest of the three, but it was out of order and remained in Chelĵmno in the yard (I saw it had one wheel taken off).*

*[...] Jews who carried the corpses from the van had to remove the wooden floor grate from the vehicle and clean the car thoroughly.”*

Just like the first Chelĵmno witness Srebrnik, this one also is at the upper range of the vans’ alleged capacity, which would have been physically impossible with the type of vans claimed by orthodox historiography. This internal consistency of falsehood indicates that both witnesses did not testify independently.

It is also interesting to note that on one of the photos of the famous Koĵo moving truck, the left front wheel can be seen as missing (see Illustration 12, p. 275). Although it is not mentioned in his statement, it is likely that Podchlebnik was shown the photos of that truck as well and that his story about the decommissioned third “large” truck missing a wheel is based on exactly this photo.

According to Podchlebnik, the regime at Chelĵmno was cruel, except that, when it comes to his escape, he forgets about this general theme and shows the SS man as a comrade willing to share even his last cigarette with an inmate (keep in mind: cigarettes in wartime Germany were rare and expensive, since tobacco does not grow in central Europe!):

*“When the truck was in the woods, I asked the escorting SS man for a cigarette. When he gave me what I wanted, I stepped back and my companions surrounded him asking for cigarettes for themselves.*

*With a sudden movement I cut the tarpaulin on the driver’s side with a knife I had on me and jumped out of the car.”*

He had a knife? Sure, every inmate had a knife. After all, that’s what inmates have...

### 3.6.2.6. The Interrogation of Mieczysĵaw Źurawski

This witness was interrogated by investigative judge Bednarz on 31 July 1945 (Bednarz 1946c, pp. 60-66). His statement does not contain quite as much information as those of the other witnesses. He describes the van as black, sealed, lined with sheet metal inside and a bathroom-style wooden grate on the floor. The exhaust pipe entered into the cargo box through a hole in the floor covered with a sieve. He was oblivious



of the van's make and of the device which allowed switching the gas from flowing into the box rather than escaping to the outside. He claimed that two vans operated at Chełmno: a larger with a capacity of about 130 people, and a smaller one for up to 80 to 90 people (all p. 62).

Regarding the duration of the gassing procedure he claims the second fastest – and unrealistically short – time of all witnesses:

*“After four minutes, when [the victims] ceased moaning – the car was moving in the direction of the crematoria.”* (p. 60)

With respect to the unloading procedure Żurawski writes:

*“After opening the car door, 5 to 6 minutes still had to pass before you could get inside. [...] I may mention that bodies found next to the exhaust pipe were burnt, so that their skin came off.”* (p. 62)

Again, since the exhaust gases created by the van were almost immediately rendered relatively harmless by mixing with the ambient air – since they were warm or even hot, they would have risen swiftly – there was no reason to wait with the unloading procedure.

The second sentence is the only reference that I have encountered so far indicating that the hot exhaust gases had a thermal effect on some of the victims. Considering that the entering exhaust gasses cannot have been much hotter than 150°C and that the corpses could not touch it due to the wooden grate, it is not perceivable how this could have lead to such intense burnings that the skin peeled off, which requires heat as is produced in fires only.

The credibility of this witness becomes clearly perceptible when he talks about the speed of cremation in Chełmno's open earth furnace, about which writes:

*“The corpses were burning fast. Approximately 15 minutes later they were already burned.”* (p. 63)

However, cremating corpses in open incineration devices takes hours rather than minutes (see Mattogno 2011a, chapter 9).

That there was some cross-fertilization among the witnesses can be seen from Żurawski's testimony about Finkelstein's unfortunate sister:

*“I heard that the worker Finkelstein had to push his sister into the furnace, who was still alive. Further details on this I do not know because it happened before my arrival.”* (p. 64)

This was only the climax of a theme which Żurawski had developed in the three preceding sentences:

*“There was an accident when guard Hannes threw one of the Jewish workers alive into a burning furnace. I cannot remember the name of the Jew. [...] There were cases where people thrown out of the van were still alive. They were nevertheless thrown into the furnace. If they groaned too loud, they were finished off with a shot from his revolver.” (ibid.)*

Well, what can we say... accidents happen.

Żurawski's story of his escape is heartening as well. He tells how he fought with a knife (another inmate with a knife) and managed to run away, even though he was shot at. There is a problem with that statement, though: Żurawski and all of the other witness stated that their ankles had been shackled together with a short chain during their entire stay at Chełmno, disabling them from walking fast, let alone running. Apparently asked by the judge to explain how he could run away with those chains, he explained:

*“On mentioning these chains, I've been shackled, so before escaping I dropped back in the granary. I had hidden a pair of large tailor's scissors, with which I cut the chain's junction link.” (p. 65)*

Sure, he swiftly cut the link of a steel chain with a pair of scissors, and all this while they were chasing him and shooting at him.

A final slip-up happened toward the end of the testimony, when judge Bednarz showed the famous Ostrowski truck photo to Żurawski as well, suggesting that he would identify it as the gas van, as the other three witnesses had done before. But for some inscrutable reason Żurawski refused to go along with the story and stated instead:

*“Having shown me the van (the van being shown to the witness is located in the former Ostrowski factory), I state that it was used to disinfect clothing. It stood in the garden of the palace (the wheels were removed).” (p. 66)*

Oops! Another Chełmno witness, the defendant Bruno Israel, could even tell details about this disinfestation truck (p. 72):

*“In addition [to two gas vans] there was a third vehicle for disinfecting clothes. This vehicle had its wheels removed. I do not know whether it served to gas people.*

*Clothes and underwear were hung into the van or put on special benches. Then a basin with burning sulfur was put inside and the vehicle closed over night. The photos shown to me (the defendant was shown pictures on cards 397 and 398 of the data sets) is the vehicle described by me.”*

These numbers refer to photos of the derelict moving van in the Ostrowski factory (see Halbersztadt's paper as quoted on p. 33). Since sulfur dioxide, the product of burning sulfur, is indeed a disinfectant used by the Germans already during WWI (usually combined with dry heat, maybe even from the vehicle's exhaust gases; see Thompson 1920), these witnesses' stories may actually have some truth to them – and may have inspired them to extrapolate the gassing of clothes to the gassing of humans.<sup>85</sup>

### 3.6.2.7. Investigative Judge Władysław Bednarz

A few words are due about the investigating judge who interrogated numerous witnesses in the context of the Chełmno camp after the war in Poland. In chapter 2.1. I've already mentioned that Judge Władysław Bednarz had the honesty to admit that the dilapidated moving truck found on the grounds of the Ostrowski factory in Koło was *not* a gas van. Bednarz has summarized his findings numerous times. The first summary was written on 7 January 1946 and was submitted as document USSR-340 during the Nuremberg International Military Tribunal (Bednarz 1946a). The excerpt read into the IMT transcript does not contain any details about the gas vans, which are merely referred to as “murder vans” by the Russian prosecutor Smirnov.<sup>86</sup> Later that year Bednarz's summary was published in Polish and English in the collections of the Polish Central Commission for Investigation of German Crimes in Poland (Bednarz 1946b), and also in 1946 Bednarz published a book dedicated to his findings about Chełmno, from which I have taken some of my above quotes of the witnesses' depositions (1946c).

In USSR-340 Bednarz wrote about the gas vans (1946a, p. 5):

*“The camp's Sonderkommando didn't have a car repair shop, so that vehicles requiring repairs were brought very quickly to the workshop of the company Kraft- und-Reichsstrassenbauamt in Koło. Eight Polish mechanics of this workshop described these vehicles' technical design as follows: the vehicle's dimensions were 2.5-3 m in width and 6 m in length; the smallest were 2.3 to 2.5 meters wide and 4.5 to 5 m long. The cargo box was made of narrow boards bolted together. Inside the vehicle was covered with sheet metal. The*

<sup>85</sup> Although convicted for his service as a German guard of the Chełmno camp in October 1945, Bruno Israel is said to have been released from custody rather swiftly (Krakowski 2007, p. 177).

<sup>86</sup> IMT, vol. 8, pp. 330f. Bednarz' names is misspelled there as Wladislav Bengash, the camp as Helmno.

*door was airtight, so any flow of air from the outside was absolutely impossible. The vehicles were dark gray. The exhaust pipe was under the vehicle and was placed in the middle of its length. The opening of the exhaust pipe inside the vehicle was fitted with a perforated sheet which prevented the tube from clogging. On the floor of the vehicle was a wooden grate. The engine was probably from the Sauer company. The driver's cabin bore the inscription 'Baujahr 1940 – Berlin' (built in 1940). Near the driver's seat were gas masks."*

Here again we encounter the technically impossible claim of a hermetically sealed cargo box. What is most interesting, though, is the claim about the vehicle's engine: a "Sauer." This name cannot have come from the truck found on the grounds of the Ostrowski factory, because this was a Magirus truck which had engines by the Humboldt-Deutz company. So where did the idea for the (misspelled) "Sauer" come from?

On page 129 I have quoted from a deposition made in the context of a Soviet show trial by a certain German defendant Fen[i]chel. This deposition had been published by the Soviet government as early as 1943 (Embassy 1943, pp. 171f.) and was also introduced during the IMT (vol. 7, pp. 572f.). In it Fen[i]chel had stated that the gas van's engine was a "Sauer" – the same typo, the same false claim that Saurer built engines for other trucks, whereas Saurer was actually a truck manufacturer. Here we have one more proof for cross-fertilization, running down from the Soviet show trials through the Polish investigations into the IMT trials. And here another interesting feature of Fenchel's description of the "hermetically closed van" just like Bednarz' description:

*"Inside [the truck] was lined with galvanized sheet iron; on the floor, also covered with galvanized iron, was a wooden grating."*

In his book on the Chełmno camp Bednarz summarized the claims made by eight Polish mechanics who claim to have repaired a gas van at one point or another, one of them the above-quoted Bronisław Falborski. However, the features Bednarz describes are restricted to the vans' estimated dimensions and their loading capacity. Then he brings up the fact that some witnesses reported about a disinfestation truck and elaborates (Bednarz 1946c, pp. 23f.):

*"Three vehicles operated at Chełmno. [...] Some witnesses also spoke of a fourth vehicle. As for the possibility that there was a fourth vehicle of a similar shape (which is currently in the former*

*Ostrowski factory at Kolo) and which was used to disinfect clothing or which was a closed vehicle for transporting Jewish workers to the forest, the statements that a fourth gassing vehicle had allegedly existed should be considered with some skepticism, as it is possible that there is an error due to the reasons mentioned above.”*

Had Bednarz been consequential, the fact that some witnesses falsely identified the Ostrowski Magirus as “the gas van,” whereas others saw in it a mere disinfestation vehicle, should have cautioned him not just about the purpose of the Ostrowski Magirus, but about all trucks claimed to have been gas vans. After all, if some witnesses were wrong about the Ostrowski truck, the others could have been just as wrong with their claims. The only difference here is that their claims could not be refuted due to the lack of any trace of any other truck. But the *lack* of evidence can never be summoned in *support* of a claim.

It may be considered a certainty that the innocuous Ostrowski truck was indeed used in one way or other in and around Chełmno. But if so, how can we be sure that any sighting by witnesses of a similar truck wasn't just as harmless a vehicle as the Ostrowski truck? Maybe *all* sightings actually concerned this truck?

Bednarz continues his train of thought as follows (*ibid.*, pp. 24f.):

*“The [gas] vehicles were often damaged, and the Sonderkommando made the mistake of not having their own repair shops. So the vehicles [...] had to be brought to the workshops at Kolo [...], whose staff was composed almost entirely of Poles. This enabled simple mechanics such as Piaskowski – card 16,<sup>[87]</sup> Falborski – card 28, Rossa – card 43, Mańkowski – card 30, Fójcik – card 222, Junkiert – card 320, Lewandowski – card 189, Jankowski – card 117, to get to know the structure of the vehicles. All these witnesses were examined at different times and even in different locations. Each of them made a sketch with their own hand of the exhaust pipe and of its entrance to the inside of the vehicle.*

*The testimony of the interrogated drivers and mechanics are completely compatible with one another and can be used to discuss the details of the gassing vehicle's design. The exhaust pipe ran underneath the car, and at half of its length it was connected with a pipe section in the cargo box floor (pursuant to the technical details*

---

<sup>87</sup> “card” refers to the card numbers of the file system Bednarz had used during his investigation (“karta śledztwa III 13/45 NT”; Bednarz 1946c, p. 12, footnote); if have not yet been able to review these other witness statements.

*of how these tubes are assembled together). The few witnesses who saw the 'Sonderwagen' from the inside (Żurawski, Srebrnik, Grabowski – card 279) concluded that the inlet of the exhaust pipe in the vehicle's interior was protected by a kind of metal sieve. On the vehicle's floor lay a second floor of wood, as in a streetcar or a bathroom. It prevented the clogging of the exhaust pipe from the inside."*

So what does the fact prove that several witnesses agreed on some sort of connection between the exhaust pipe and the cargo box? Since by 1945 the claim of German murder vans using exhaust gasses to kill people had been bandied about for some three years, anyone asked to draw a sketch of the gassing mechanism would have drawn some connection from the exhaust pipe to the interior of the cargo box. It doesn't take a rocket scientist to figure that one out. But the quality of these drawings clearly reveal them as worthless scribbings (see Falborski's sketch on page 353).

The next three paragraphs in Bednarz's description are about an entirely new issue: the alleged use of some mysterious additives mixed into the gas van's gasoline in order to make it more poisonous (*ibid.*, pp. 25f.):

*"It could not be established whether only the vehicle's exhaust gas was used for poisoning or whether some other substances were added to the oil or gasoline in order to accelerate the process of poisoning. In that regard, there is no sufficiently reliable data. It was only observed that some balloons and bottles of unknown chemicals were constantly coming in for the Sonderkommando (witness Bosiński – card 432).*

*The driver of SS Dr. Ralf König, Grabowski, testified that he had once used the gasoline borrowed from the Sonderkommando. When he turned on the engine – as usual in the garage – he felt that he was losing consciousness ('I felt lightheaded and I felt a slightly sweet taste on the lips' – card 279). This witness testified further: 'Dr. König, when I told him about it, absolutely forbade me to run the engine in the garage in case the gasoline came from the Sonderkommando.'*

*The driver Piaskowski (card 17) testified that during one of the repairs he had started the 'Sonderwagen's' engine in a closed gar-*

*age. The result was similar to that described by chauffeur Grabowski \*).*"<sup>[88]</sup>

In this context a certain Kazimierz Grabowski testified during the trial against Rudolf Höß, former commander of the Auschwitz camp, that the engine of a gas van was fueled with methanol (Höß Trial, vol. 26, pp. 32f.). I am not sure whether this is the same witness, though.

It goes without saying that mixing any chemical additives to the gasoline in order to accelerate the gassing procedure wouldn't have made any sense, as those additives would have burned in the engine before exiting through the exhaust pipe. This section merely proves how rumors grew and were spread among the witnesses and how they were willing to back them up with purely invented stories about sweet tasting exhaust gases and doctors giving stupid advice. (Any doctor would have advised not to let any engine run in an enclosed space, not just when the gasoline came from certain sources.)

The information given in the final paragraph of Bednarz's description of the alleged gassing trucks deployed in Chelmno is somewhat more detailed than what he wrote in USSR-340 (*ibid.*, p. 25f.):

*"The witnesses determined the vehicle's dimensions as follows: 2.5 to 3 meters wide, about 6 meters long, when it comes to the larger vehicles, and 2.3 to 2.5 m wide and 4.5 to 5 m in length regarding the smaller vehicle. The cargo box was built with narrow, tight, closely connected boards so that the car could give the impression of an indoor paneling. The interior was lined with sheet metal, and it had sealed doors. All the cars were dark gray, almost black. The engine was probably of the 'Saurer' brand (Lewandowski, Rossa)."*

Here Bednarz has corrected the misspelled Saurer name, but still: either the entire vehicle was a Saurer, or if not, then the engine wasn't a Saurer either. Plus, if it had been a Saurer truck with a Saurer engine, it would have had a Diesel engine incapable of killing in the manner described by the witnesses. In addition, the cargo box of the innocuous Ostrowski moving truck was also made of tightly connected wooden boards with a sheet metal lining on the inside (see Illustration 15f.). Hence this alleged feature of the "gas vans" could originate from cross-fertilization among erring or lying witnesses.

---

<sup>88</sup> In a footnote Bednarz states that the Central Jewish Historical Commission has a German document speaking of "*Spezialbenzin*" – special gasoline.

### 3.6.3. Israel

#### 3.6.3.1. Szymon Srebrnik

The three witnesses whose depositions before a Polish investigative judge have been analyzed in the three previous subchapters – Srebrnik, Podchlebnik and Żurawski – also testified during the Eichmann trial in Jerusalem during the 65th and 66th session, 5 & 6 June 1961.<sup>89</sup>

The first interesting passage of Srebrnik’s testimony from a critical point of view is the following:

*“When I arrived [at Chełmno], the building had been blown up, and we were told [...] to clean it. [...] We began cleaning the stones and everything. We found bones there, and all kinds of things – skulls, hands and legs. We did not know what it was. [...] it was explained to me that there had been a magnificent villa there, a beautiful building, and there had been Jews inside. They had contracted some sickness. They put them inside, and blew up the building together with them.”*

It goes without saying that destroying an large building for the sake of killing a number of sick persons isn’t exactly a rational way of committing mass murder or fighting disease, all the more so since the Germans lacked housing due to the Allies’ bombing campaign and would therefore never have considered such lunacy. This story has a parallel in a tale given by a defendant during a German trial held some six years later, which we will encounter in chapter 3.7.4.6.

An interesting feature of the Eichmann trial is that, for long stretches during interrogations of witnesses, it is not the witnesses who tell a story but rather the prosecutor who merely asks the witnesses to confirm a certain claim or to specify an issue about an event assumed to be self-evident. For instance, the very first time gas vans are mentioned during Srebrnik’s interrogation is by the prosecutor, who suddenly changes topics and asks him:

*“Q. When did the gas trucks arrive?”*

Under a proper court of law in a state under the rule of law, such a question would never have been permitted. It’s like asking a person: “when did you rape your wife?” It is clear from this that the Eichmann trial was not about establishing things, but merely to get them confirmed and filled in with a few more details.

---

<sup>89</sup> State of Israel 1993, vol. III, pp. 1190-1201; I subsequently quote from the internet version .../Session-066-01.html to .../Session-066-03.html.



In contrast to Srebrnik's 1945 maximalist claim about the vans' capacity, he reduced it during the Eichmann trial to "eighty to a hundred people." This is all we can learn about the gas vans from his testimony.

The tall tale told in 1945 about Finkelstein's living sister in the flames received a workover, as he no longer claims that she came back to life in the flames, but he repeats the miracle of how he survived being shot in the neck, showing the court some scars allegedly stemming from that event, even though the wounds to his nose are now said to have been caused by some glass slivers.

Although the Jerusalem prosecutors or judges were in general quite credulous, there were moments during the trial when they were not quite inclined to follow Srebrnik. One of these occasions concerned the alleged death toll of the camp during Srebrnik's presence in 1944. Right after the war in 1945 he had stated (Srebrnik 1945):

*"I estimate that in 1944 alone 15,000 Jews were brought to Chelmno. However, I did not count them – my assumption is based on what the gendarmes had said before the transports arrived. That is why I claimed that in 1944 15,000 Jews were killed in Chelmno."*

During the Jerusalem trial in 1961, however, he claimed that the Germans had killed 1,200 Jews more or less every day for nine months straight:

*"Q. How many people were brought to Chelmno for extermination, after they began arriving?"*

*A. About 1,000-1,200.*

*Q. Every day?"*

*A. Yes. [...]*

*Q. I understood that there were exterminations for about nine months while you were there?"*

*A. Yes, [...]*

*Presiding Judge: Did they put 1,200 people to death every single day?"*

*Witness Srebrnik: That was more or less every day."*

This the Presiding Judge could not believe, hence he asked the witness a final question:

*"One of the witnesses who preceded you [Mieczysław Żurawski] gave much lower figures."*

But Srebrnik insisted on his figures, even though mathematically speaking this would have amounted to the absurdly high figure of (9 months × 30 days × 1,200/day =) 324,000 victims (minus an occasional

“break of one day, in order to grind the bones,” as Srebrnik adorned his gory tale). After this the witness was dismissed by the judge, who obviously had enough of Srebrnik’s tales.

The more time passed, the bigger Srebrnik’s figures got. During the first minutes of Lanzmann’s movie *Shoah*, Srebrnik even claimed (Lanzmann 1985):

*“It was always this peaceful here. Always. When they burnt 2,000 people – Jews – every day, it was just as peaceful.”*

So from 15,000 in 1945 we arrive at (9 months × 30 days × 2,000/day =) 540,000 during his *Shoah* Interview in the 1970s. And these are only figures for that second (1944) period of the camp, resulting in even higher figures when considering the claimed first, much longer extermination period of that camp (1941 to 1943). Not even orthodox historians insist on such extreme figures.<sup>90</sup> I have elaborated elsewhere in more detail on Srebrnik’s lies (Alvarez 2011), and so has Mattogno with more arguments (Mattogno 2011a, chapter 7.2.2.).

### 3.6.3.2. Michał Podchlebnik

Podchlebnik’s testimony during the Eichmann trial is evidently a coached retelling of his 1945 Polish testimony, since the prosecutor asked the witness to confirm one event after the other in the sequence as described in his 1945 affidavit, including his miraculous escape thanks to the generous SS men. A few unbelievable passages which I have criticized in chapter 3.6.2.5. were left out, though, for instance the running Germans, the pornographic fantasies, and the gassed Ukrainian. Reading into the record a postwar Stalinist document and having it merely uncritically confirmed by the witness reveals the charade which the Eichmann trial really was (State of Israel 1993; .../Session-065-05.html to 06.html).

### 3.6.3.3. Mieczysław Żurawski

Żurawski’s statement in Jerusalem was cleansed as well from all but one of the implausibilities of his 1945 statement as listed in chapter 3.6.2.5., although in this case the prosecutor did not follow the 1945 affidavit as strictly as in Podchlebnik’s case (State of Israel 1993,

<sup>90</sup> The Bonn Jury Court determined “at least 145,000” for the camp’s first period and “at least 7,100” for the second, so a total of at least 152,100 (Rüter *et al.* 1968ff., vol. 21, pp. 235, 241, 263, 286).

.../Session-065-06.html). But Żurawski came up with a new outrageous tale he had not mentioned back in 1945:

*“So they [the Germans] lined us up with bottles on our heads and had their game of target practice. Those whose bottle was hit stayed alive, and those they hit in the head – fell, and the others had to bury them.”*

It goes without saying that this tale is technically and physically possible, but whether one believes it is a matter of probability and personal inclination, that is to say: if you think that the Germans during World War II were a race of devils and that the witnesses testifying in Jerusalem were inclined to tell the truth, then this event would very well have been possible.

Another interesting aspect of Żurawski’s testimony is his response to the question as to what happened to the gas vans after the dissolution of the Chełmno camp:

*“Q. What happened to the gas vans?”*

*A. The gas vans were also taken in the direction of Kolo.”*

This is, of course, the location where the famous moving van was found on the grounds of the Ostrowski company, so this brief episode can be regarded as an attempt to remedy the slip-up in Żurawski’s 1945 testimony about the truck found there having been used for disinfection.

The one implausibility which reoccurred in Jerusalem was Żurawski’s story about his escape. This time the interrogator simply didn’t ask any “stupid” questions raising the issue of how Żurawski got rid of his chain, so the absurdity remained inconspicuous to the uninformed reader/listener.

#### 3.6.4. Austria

Here, too, I rely on what Kogon *et al.* mention with regards to a trial conducted by the *Landesgericht* in Vienna in the early 1960s (1993, pp. 78f.). Their only reference to this trial consists of a quote from a summary of the interrogation of two defendants given only by the initials of their last names. In it gas vans are mentioned only in passing: “The people were killed by piping in engine exhaust fumes” (*ibid.*, p. 79). The verdict of the LG Kiel of 11 Apr. 1969, p. 39, mentions a pending criminal investigation in Austria against the driver of an alleged gas van referred to there only as “We.” So far I have not been able to obtain any information about this case.

Another trial was in preparation in Austria in 1967 against Herbert Andorfer for his involvement in the claimed mass murder of Jews held in the Semlin camp in Serbia (*Landesgericht Wien*, 27e, Vr 2260/67). Since Andorfer had immigrated to Venezuela after the war and had received citizenship there, Austria eventually decided that he was no longer an Austrian subject. Andorfer was subsequently extradited to Germany, where he stood trial for the above mentioned charges (see chapter 3.7.4.8.).

## 3.7. Gas Vans during West-German Trials

### 3.7.1. Introduction

Since the trials conducted in communist East Germany until its collapse and reunification with West Germany in 1989/1990 were radically different from those conducted in the West Germany, I will deal with the communist trials in chapter 3.8.

All in all 27 trials were conducted in the Federal Republic of Germany (West Germany) by German courts of law addressing in one way or other the alleged mass murder committed with gas vans.<sup>91</sup> A summary of the verdict data is given in Table 4. It is impossible to cover all of these trials in detail, but I will give a summary of each and discuss the issues pertinent to our topic. Unless otherwise stated, all page numbers given in the subchapters of this section refer to the respective volume as given in Table 4.

Since court verdicts tend to mention primarily the evidence which justifies their verdict, judging the cases by their verdicts alone results in a lopsided perspective. Hence, in order to do each case justice, one would have to read the entire case file compiled by the prosecution during the time between opening the investigation until right up to the trial. It goes without saying that these files would also be lopsided, as prosecutors in such cases frequently tend to merely find culprits for crimes which are considered self-evident rather than scrutinize the historical record. Yet still, experience shows that many revealing witness statements not fitting into the prosecution's agenda are silently dropped and are subsequently also not quoted in the "scientific" literature. Today

---

<sup>91</sup> Since some of them are mere retrials of successful appeals, the number of unique cases is actually only 24.

**Table 4:** West-German Court Cases Addressing Gas Vans

VOL.*	# (COURT, DATE OF VERDICT IN YYMMDD)**
VII	231 (LG Stuttgart, 491108; 500815)
IX	298 (LG Karlsruhe, 491215; 511107), 310 (LG Wiesbaden, 520324)
XI	362 (LG Köln, 530620)
XVIII	526 (LG Karlsruhe, 611220)
XIX	552 (LG Koblenz, 630521), 560 (LG Karlsruhe, 631213)
XXI	594 (LG Bonn, 630330, 650723)
XXII	601 (LG Koblenz, 651110), 603 (LG Kiel, 651126), 606 (LG Wuppertal, 651230; 671213)
XXIII	624 (LG Frankfurt/M., 660312), 632 (LG Hannover, 660607)
XXVI	658 (LG Stuttgart, 670915)
XXIX	679 (LG Stuttgart, 680611)
XXXI	700 (LG Dortmund, 690116)
XXXII	702 (LG Kiel, 690411), 703 (LG Darmstadt, 690418)
XXXIII	720 (LG Kiel, 691128)
XXXV	750 (LG Frankfurt/M., 710319)
XXXVI	765 (LG Darmstadt, 711223)
XXXVII	769 (LG München I, 720322), 777 (LG München I, 720714)
XXXIX	807 (LG München I, 740329), 809 (LG Kiel, 740614)†
XL	816 (LG München I, 741115)
XLIV	864 (LG München I, 801219)

\* Volume of Rüter 1968ff.; \*\* case no. acc. to Rüter;

† case 795 of this volume (LG Hamburg, 5 June 1973) does *not* deal with gas vans, in contrast to the false claim on the Rüter webpage at [www1.jur.uva.nl/junsv/brd/files/brd795.htm](http://www1.jur.uva.nl/junsv/brd/files/brd795.htm)

these investigation files are held by the German Federal Archives in its Ludwigsburg branch. Access to them is basically impossible for notorious revisionists, as a revisionist's application to use the archive would probably result in a refusal at best and immediate arrest at worst rather than access to the documents.<sup>92</sup>

It would also be conducive to consult verbatim records of the court proceedings. All of the court cases dealt with here were conducted on the second level right from the start due to the severity of the alleged crime (*Landgericht*=LG). The German penal procedure does not permit any appeal of matters of fact in such cases, so that verbatim records are useless, since no court will ever check the facts assessed and “established” by the judges during such a trial. As a result, trial records were actually even abandoned in Germany in the 1970s for this type of court, while they had already been mere scant summaries rather than verbatim recordings before that.

<sup>92</sup> An application to use the archive has to be filed in advance and has to contain personal data as well as information about the project for which the material will be used, see [www.bundesarchiv.de/imperia/md/content/bundesarchiv\\_de/benutzung/vordruck\\_neu.pdf](http://www.bundesarchiv.de/imperia/md/content/bundesarchiv_de/benutzung/vordruck_neu.pdf).

Hence we have to make do with breadcrumbs for now, that is, with what the judges deemed to be important. Later generations of critical researchers may be able to do a better job, once they manage to get to the core of this documentation.

I have split up the West German trials into four subchapters, which does not only serve to make the chunks more digestible, but also to give an impression about the temporal clustering of these trials<sup>93</sup> reflecting a general tendency of trials against alleged NS criminals. Right after the creation of the Federal Republic of Germany in 1949, West German courts continued these trials mainly as a legacy of the various Allied tribunals. But with the rising Cold War, pressure to prosecute German veterans soon decreased, as the Western Allies needed those veterans' support in building up a new German army as a bulwark against communism. In addition, since the German judiciary is organized by the German *Länder*, a central authority investigating NS crimes on a national and international level was missing.

After some political pressure by interested lobby groups, such a body was formed in 1958: the *Zentrale Stelle der Landesjustizverwaltungen zur Aufklärung nationalsozialistischer Verbrechen* (Central Office of the State Justice Administration for the Investigation of National Socialist Crimes), which is basically an official (initially only West) German Nazi hunter organization. This office's activities, together with the fear that the statute of limitation for murder would soon make the prosecution of the alleged perpetrators impossible, led to a rising tide of court cases in particular during the second half of the 1960s. This fear proved to be misplaced, however, as the same pressure groups which had pressed for the creation of West Germany's Nazi hunter organization also successfully lobbied for the repeated extension and finally for the abrogation of the statute of limitation for murder. Ever since the number of trials has steadily declined simply due to the fact that most cases had already been dealt with, that the defendants are no longer alive, and that new evidence, which usually is almost exclusively anecdotal in nature, was harder to come by as time passed by.

The mindset of the persons working in the *Zentrale Stelle* can be determined by the sources they quote, for which the book by Kogon *et al.* (1993) is a textbook example. One of the main editors of this tome, Adalbert Rückerl, was the head of the *Zentral Stelle* between 1966 and

---

<sup>93</sup> Mere retrials of successful appeals are always treated together with the first trial.

1984. His office delivered the bulk of the evidence on which this book, co-edited by him, is based, which consists mainly of postwar testimonies of defendants and witnesses. When it comes to the gas vans, it is striking that Kogon *et al.* also refer to the “evidence” gathered during the Kharkov and the Krasnodar trials without even a hint of criticism (*ibid.*, pp. 62, 67; fn. 50, p. 261). They even quote from the propaganda work *The Black Book* by Soviet atrocity propagandist Ilya Ehrenburg (*ibid.*, p. 64; fn 45, p. 261), plus Herr Fenichel as published in a wartime Soviet propaganda brochure (see chapter 3.5.1., p. 129) is quoted as well (*ibid.*, p.; fn. 58, p. 261). This clearly indicates that the West German criminal investigations into these alleged crimes were nothing else but yet another extension of the Soviet wartime show trials.

Before turning to the individual cases, I may briefly analyze the punishments meted out against the defendants in the trials I am about to review, see table to the right.<sup>94</sup> All in all 69 defendants were tried in these West German cases, although not all of them for their alleged involvement in gas van murders. If a defendant was punished, it was either for manslaughter or for aiding and abetting in murder. Not a single defendant was punished for murder, as they were all assumed to have merely assisted the main villains (Hitler, Himmler, Heydrich etc.). As can be seen from the tabular listing, 21 of the defendants were either acquitted or not punished, be it because the court abstained from doing so or because the case was shelved. 25 defendants received prison terms of less than five years. Five

### **Punishing Gas Van Killers**

WEST GERMAN VERDICTS	#
life terms:	2
15 years and more:	1
10 to less than 15 years:	6
5 to less than 10 years:	14
less than 5 years:	25
acquittals or no punishment:	21
number of defendants:	69

### **Punishing Revisionists**

DEFENDANT	YEARS
Horst Mahler	11 <sup>*†</sup>
Ernst Zündel	7 <sup>†</sup>
Günter Deckert	5 <sup>‡</sup>
Germar Rudolf	3 <sup>2/3</sup> <sup>‡</sup>
Sylvia Stolz	3 <sup>1/2</sup> <sup>*</sup>
Udo Walendy	2 <sup>1/2</sup> <sup>‡</sup>
Otto E. Remer	1 <sup>5/6</sup>
Fredrick Töben	<sup>5/6</sup>
Siegfried Verbeke	<sup>3/4</sup>

\* For a combination of historical and political statements.

† Including two years in Canada, which the German court refused to acknowledge.

‡ Accumulated term of two or more cases, served together.

<sup>94</sup> life + 15; life + 8, 15, 3 × 13, 12 (appeal shelved due to unfitness), 2 × 10, 3 × 8, 4 × 7, 2 × 6<sup>1/2</sup>, 5<sup>1/2</sup>, 4 × 5, 8 × 4<sup>1/2</sup>, 6 × 4 (one not enforced), 3<sup>1/2</sup>, 2 × 3, 2 × 2<sup>1/2</sup>, 2 × 3, 4 × 1 + 6 weeks, 21 × acquittals or no punishment (including Becker for unfitness; Heinz G. Rie. for allegedly gassing partisans).

years imprisonment is considered the threshold beyond which prison terms really start wreaking havoc on a defendant's life. Hence 46 of 69, that is two thirds of all defendants got away rather cheaply.

Juxtapose this with the prison terms meted out in West Germany for doubting or contesting the claims made by these West German court verdicts – that is to say: punishments of Holocaust revisionists, see the table just underneath the one mentioned previously listing some of the most prominent cases. One of them, Sylvia Stolz, is actually a lawyer who was punished for her defense activities on behalf of Ernst Zündel.

From this we can see that today in West Germany the judiciary punishes a defendant who kills one Jew or even a great many of them with a similar severity as it punishes a defendant who disagrees with a Jew (or a German judge, for that matter).

### 3.7.2. From 1949 to 1959 (4 trials)

#### 3.7.2.1. LG Stuttgart, Verdict of 8 Nov. 1949 & 15 Aug. 1950

During this trial a defendant was prosecuted who had been incarcerated since war's end and was to see the light of day no more in his life: Ferdinand Göhler. In 1941 he was employed in the town administration of Kalisch, where he was also concerned with the administration of the camp Bornhagen (Polish: Kozminek), where Polish Jews had been incarcerated. Although the original indictment of 25 April 1949 accused him of having been involved in the resettlement of Jews at the end of November 1941 (p. 190, 217), during which several hundred Jews are said to have been killed by means of "gas vans," the court of the first trial declared this case beyond its jurisdiction. As this decision was confirmed on appeal, this issue was no longer dealt with in detail during the retrial of the case in 1950, so no verdict was passed in this regard at all (p. 191). The court nevertheless made a few statements in this regard, which I quote:

*"The removal was done with a special vehicle, which had the shape of a moving truck and which could be entered from the back. Due to its dark paint, it was called 'black van.' According to the opinion of the Jewish witnesses, a gassing device was installed inside of it, which could be turned on during transit. Nobody could make specific statements about this [...]." (p. 200)*



*“The so-called black vehicle was a large truck, which looked like a moving truck and whose interior was lined with sheet metal. An invisible device to be operated from the driver’s cabin was installed in its interior, through which a lethal gas could be released into the enclosed vehicle, a device which was started soon after the truck had driven off so that the Jews inside the vehicle could be killed during transit.”* (p. 231)

*“In this capacity [the defendant] then participated in the gassing action of 26 Nov. 1941. This was implemented in such a way that the Jewish inmates assigned for this were loaded into a special vehicle, a so-called ‘black vehicle,’ on the square in front of the synagogue in Bornhagen in the presence of the raiding squad: the vehicle resembled a moving truck, and in its interior, which was sealed airtight, pipes had been laid so that the occupants could be killed during transit.”* (p. 239)

It is worth noting that the gas vans employed by the Soviet Secret Services before the war seem to have been based on black prison transport vehicles (“Black Maria,” see chapter 3.2.1.), yet that only a minority of witnesses of the alleged German “gas vans” stated that they were black (see chapter 4.2.), whereas most witness claim colors similar to those usually applied to German military vehicles (grey, sometimes with a brownish or greenish hue). The “moving truck” theme, which we will encounter in numerous German court verdicts, probably is an outcropping either of the early Soviet show trials claims (see *The Peoples’ Verdict*, p. 29) or of the Koło Magirus moving van falsely identified by Falborski *et al.* as “the gas van” (see chapters 3.6.2.3ff.). The claim of a separate gassing device in the van’s interior which could be turned on from the driver’s cabin during transit is in conflict with most other witness statements as well (see chapter 4.2.6.), which insist on engine exhaust gases being used, a process which had to be initiated while the truck was standing still. The issue of an allegedly airtight gassing box need not be addressed here again.

Furthermore, the claim that the Bornhagen camp had “gas vans” at its disposal at the end of November 1941 is not credible. The very first gas vans claimed to have been deployed by the Germans are said to have been delivered only toward the end of November/early December 1941, if we believe the orthodox version (Beer 1987, p. 412, who does not mention this verdict). It does not appear likely that the unimportant

little camp of Bornhagen was the first to receive one, nor is such a claim backed up by anything.

Despite the collective length of these two verdicts and their associated appeal decisions, little more can be gleaned from them for the present technical purpose. The court itself stated that many testimonies were presented to the court only in writing, since most witnesses had emigrated from Germany at the time of the trial and were therefore unable to testify in person. Since the various testimonies about the defendant's alleged crimes were riddled with contradictions, impossibilities and "untrue statements," the court moreover stated:

*"These contradictions about the descriptions of the incidents are so huge and affect the decisive events so much that no findings could be made which would suffice for a conviction."* (p. 205)

Many such "untrue statements" were never even detected by the court. For instance, one witness implied that mass murder with gas vans had occurred as early as 1940 (p. 228), which indicates that just about any van or truck picking up inmates was a target for being named a "gas van" by some witness.

So how could the court be so sure that the alleged mass murders with a gas van took place in the first place? I quote:

*"Finally it has become generally known from the war crimes tribunals that countless Jews had been exterminated in such a way."* (p. 234)

That the historical "truth" had been cast in stone at the very outset of this trial is also hinted at by the verdict of the Mannheim Upper District Court (*Oberlandesgericht*). After the first verdict had been handed down on 8 Nov. 1949 by the LG Stuttgart, the defendant filed an appeal with the Mannheim Upper District Court, in which he requested, among other things, that the LG Stuttgart also rule about the alleged mass murder with gas vans. In its decision the Mannheim court rejected this request, stating among other reasons also (p. 244):

*"An acquittal is legally out of the question already because the authorization by the military government does not extend to the sentencing of this case under the aspect of crimes against humanity."*

This indicates that the German postwar trials in such cases were indeed little more than extensions of the Allied postwar trials.

### 3.7.2.2. LG Karlsruhe, Verdicts of 15 Dec. 1949 & 7. Oct. 1951

During this trial Adolf Rube was tried and sentenced to life imprisonment plus 15 years for murder and 26 cases of manslaughter, which he is said to have committed between late 1942 and summer 1943 while doing an office job for the Security Service (*Sicherheitsdienst*). The verdict relies heavily on the IMT, whose determinations about the alleged National-Socialist measures for the physical extermination of the Jews the court considered to be facts “notorious to the court” (p. 13), or in other words: they were not subject to discussion.

Before we turn to the German trial, I want to briefly discuss Rube’s role during the Nuremberg trials. Rube had been arrested by the Allies right after the war and was made to write an affidavit, in which he related the following atrocity story, among other things (NMT, vol. 4, p. 473):

*“On the occasion of an exhumation in Minsk, in November 1943, Obersturmfuehrer Heuser arrived with a Kommando of Latvians. They brought eight Jews, men and women, with them. The Latvians guarded the Jews, while Harter and Heuser erected a funeral pyre with their own hands. The Jews were bound, put on the pile alive, drenched with gasoline and burned.” (NO-5498.)*

This is said to have happened at a time when the Germans were retreating at all fronts and are said to have been in the process of excavating hundreds if not thousands of mass graves in Russia in order to cremate the remains of their mass murders in an attempt to destroy material evidence. That is also the background why those eight Jews are said to have been burned on a pyre instead of simply being shot. However, considering that one needs some 200 kg of wood per person for a successful cremation, that therefore the suggested pyre for eight persons had to contain some one and a half metric tons of wood, how likely is it that two German officers did the job all by themselves, while their Latvian helpers just stood by and watched? This gives a clear indication about the truthfulness of Rube’s statements made under the duress of Allied incarceration. His statement clearly served merely to incriminate his superiors and to buy himself freedom from prosecution.

In his NMT statement Rube also details the events of an alleged mass shooting of 1,800 Jews in the Sluzk ghetto in February 1943 (*ibid.*, pp. 564f.). At the end of his statement he mentions his then superior SS-*Obersturmbannfuehrer* Strauch, who was one of the defendants

of this NMT trial. Rube's affidavit, among other things, sealed Strauch's fate.

Although Rube was released from Allied custody after signing his affidavit, it bought him freedom only for a short while. Still before the creation of the Federal Republic of Germany he was arrested by "German" authorities and put on trial himself. Although the verdict against him mentions his involvement in the above-mentioned alleged execution of Jews from the Sluzk ghetto (pp. 12, 36), this was not the focus of the trial, as Rube had successfully claimed to have been a mere spectator of this event. The focus of this German trial was Rube's alleged involvement during the elimination of the Minsk ghetto, where numerous witnesses claimed that he had committed cruelties and murdered some of the ghetto's occupants.

Since Rube had helped with his affidavit for the NMT to cast the official version into stone, he had no line of defense left during his own trial. It is again important to note that this court as well made ample use of testimonies from hearsay and presented written statements by witnesses who never appeared on trial. Their statements had been taken much earlier and sometimes even during the so-called "*Spruchkammer*" trials (pp. 23f.), which were Allied postwar denazification tribunals with no legal basis and no due process. It is in this context that a gas van is mentioned (*ibid.*). Except for the number of people allegedly forced into this vehicle (50 to 80, p. 24), no details are given.

Rube's defense in this context is very interesting. He admitted the existence of one such van, yet claims that the "gas pipe had been defective, as a result of which the van had never been used" (p. 27). Since the court could not establish that Rube had ever been involved in the use of such a van, he was acquitted of the according charge.

All we can learn from this case is that there is a strict historical and legal continuity between the Allied postwar tribunals and the subsequent (West) German postwar trials, where the conditions may have been more humane, but a defense regarding gas van (and other) claims was possible only when accepting the main line of the orthodox version of history.

### 3.7.2.3. LG Wiesbaden, Verdict of 24 Mar. 1952

This trial is interesting, as it ended with an acquittal for all five defendants who had been accused of wittingly causing the death of numerous individuals by transferring them from regular prisons to concen-

tration camps. But these jurists all managed to convince the court that they did not know what was going on in the concentration camps.

Gas vans were not in the focus of this trial. Only on two occasions a gas van was mentioned, although they are both interesting cases, as they show how rumors spread and multiply. The first case was attested to by an unnamed witness:

*“When he was in the Monowitz camp, which belonged to Auschwitz, his health deteriorated so much that he was supposed to be gassed. He was hauled into a gas van, in which the inmates were gassed on the way to the crematoria.”* (p. 325)

Needless to say that he miraculously escaped his own gassing, because some physician put a stop to it by claiming that on that day the camp had to be squeaky clean due to a visit by some delegation of officers. The problem with this is that even orthodox historians reject this alleged gas vans deployment in Auschwitz as untrue. Yet the Wiesbaden court believed the witness, which shows how credulous German courts are when it comes to believing just about anything a former inmate tells.

The second case was attested to by a prosecutor working in Linz, Austria, during the war (p. 354):

*“This witness definitely knew about the extermination methods in the individual camps. But it is telling that he did not find out about it due to his activity in the office of the attorney general, but incidentally when working at a German district court in The Haag. [...] In Holland the witness also heard before March 1943 about the invention of a Berlin police officer. According to this exhaust gases were piped into hermetically sealed vehicles in order to kill inmates.”*

If considering that Holland was a hotspot of Allied propaganda efforts and mass gassing claims (Kues 2010), we can see where this “knowledge” came from.

#### 3.7.2.4. LG Köln, Verdict of 20 June 1953

The defendant of this trial was the former *SS-Oberführer* and Colonel of the Police Dr. Emanuel Schäfer, who was responsible for the Semlin *Judenlager* (Jewish camp) near Belgrade, Serbia. Most of the verdict deals with considerations about the execution of two hostages, which is irrelevant in the present context. Since the 7,000+ inmates of the Semlin camp are said to have been gassed using a Saurer truck es-

pecially transferred for this purpose (see chapters 1.2., 2.2.7. and 4.1.), Schäfer found himself in an uncomfortable position. In this context the court introduced the documents of 501-PS, which gave Schäfer no room to maneuver. The verdict states:

*“One day in the spring of 1942, presumably in early March 1942, a telegram of the RSHA arrived from Berlin which was marked as ‘Secret State Matter’ and which was therefore immediately shown to the defendant. The telegram which no longer exists [how convenient!], had the following content according to the defendant’s own statement:*

*‘Re: Jewish Action in Serbia,  
Einsatzkommando with special vehicle Saurer on route by road with special order.’*

*The defendant was immediately aware of the telegram’s meaning. He knew that this was about the killing of the Jews still present in the camp in Belgrade, all of them Jewish women and children.”* (pp. 152f.)

In fact, the defendant himself had claimed during the trial to have become “immediately aware of the telegram’s meaning.” The court summarized his statements as follows:

*“When the telegram announcing the arrival of the special Saurer vehicle had arrived at his office and was presented to him, he knew immediately what this was all about. He immediately recognized the announced action against the Jewish inmates of the Semlin camp as plain, mean, cowardly murder. He felt nauseated. But he claimed to have been unable to do anything about it. It has been an inevitable Führer order. [... Resistance] would have meant mortal danger. It would also have been absolutely impossible to sabotage the announced measures or to resist them in any way. He had no other choice but to let the announced measures unfold.”* (p. 164)

Anyone reading this has the right to feel nauseous himself. Such defendants who obsequiously followed even the most cruel and obviously illegal order deserve our utmost disgust.

But how could Schäfer have known what the telegram meant? There is nothing in the alleged telegram’s claimed text hinting at any criminal meaning. This suggests that what he told the court is knowledge in hindsight at best. And in addition: which Führer order is he talking about? No such order was ever found! Hence it probably never existed!

It was invented by defendants like Schäfer in an attempt to hide behind it.

Moreover, if the Saurer *Diesel* engines couldn't do what Schäfer and the verdict claim they did (killing within 15 minutes), if therefore his testimony isn't true, then why would he say such things?

The answer to this question lies in what I have stated in chapter 3.4. about the impossible situation German defendant's found – and are still finding – themselves in during postwar trials. Schäfer was the responsible person for what happened in that camp, as the court correctly established:

*“The Semlin Judenlager was under the defendant's control. This means that nobody could carry out an order in this camp without his permission and cooperation.”* (p. 166)

So if the “truth” is a lie but is cast in stone, how would you defend yourself as the one whose signature is under each document, real and fake? Now read Schäfer's statement once again. He chose the only path open to him. It is a lie itself, as it can be assumed that during the war he mostly did what he thought was right and necessary. The disgust he claimed to have felt when he read the incoming telegram is itself a lie serving yet another lie: that he wanted to resist but couldn't. The only credible version is that back then he didn't see a reason to resist. And this was not so because he was a monster – the court itself stated eight times that he was a decent man (pp. 159, 161, 163, 168 (2×), 169 (2×), 171)<sup>95</sup> – but because he didn't see anything monstrous happening.

Although the court claims that its allegations regarding the deployment of these “gas vans” are partly “based on the defendant's own statements” (p. 154), it is unclear which part of it was confirmed by the defendant in which way, as the other part of the court's story not backed up by documents had been contributed by unspecified witnesses, about whose testimonies we learn nothing from the verdict.

About the “gas van” itself the court stated:

*“The special vehicle Saurer was a especially constructed vehicle for this purpose, with which the exhaust gases of the running engine were piped into the interior of the closed vehicle by means of a spe-*

---

<sup>95</sup> Even more so in a different verdict against Schäfer for his role in the deportation of Cologne's Jews, case 403, LG Köln, verdict of 9 July 1954, Rüter *et al.* 1968ff., vol. 403, pp. 575-602. During this trial Schäfer claimed he had sincerely thought the Jews would merely be resettled “like the Red Indians were into some reservation.”

*cial device (lever and hoses), so that the persons in the interior were put to sleep and died of a carbon oxide poisoning.” (p. 153)*

A special device, indeed, sporting a lever and several hoses at once. The notion that a lever was used to “turn on” the gassing was probably inspired by the Becker document, which mentions such levers without specifying what they were, even though from the context it is clear that they were allegedly used to fine-tune the procedure, not to turn it on and off (see page 53).

Nothing in the verdict indicates who came up with such a description, but it probably stems from the defendant, who most likely just made up what he thought would have been the likely setup. Again the court:

*“After three days the Sonderkommando consisting of the SS-Scharführer Goetz and Meyer arrived in Belgrade with the special vehicle Saurer from Berlin. [...] In the course of this time the Jewish men, women, and children present in the Semlin camp were handed over to them for removal by means of the ‘gas vans.’ It was feigned to the Jews that they would be relocated to a different, better camp. To make this deception more credible, it was ordered that the Jews had to take along all of their belongings. Hence the victims let themselves being duped and credulously climbed in groups of 25 persons into the death van in hope for better living conditions. The vehicle was closed and started moving. During transit the driver directed the engine’s exhaust gases through a hose into the vehicle’s interior by means of a lever, so that the occupants fell asleep in the way described above [...].” (ibid.)*

So now we know for sure: the lever to switch the gassing on and off was in the driver’s cabin and could be operated by the driver during transit! Quite fanciful indeed.

According to another source, though, that lever is said to have been at the *outside* of the truck (Manoschek 1998, p. 230, referring to Landesgericht Wien, 27e, Vr 2260/67):

*“One of the two drivers, Wilhelm Götz or Erwin Meyer, got out and turned the lever at the outside of the truck, so that then the exhaust gases would be led into the vehicle’s interior.”*

Considering that the Saurer vehicles could allegedly accommodate up to 100 victims at a time, the court’s claimed load is a little off, but that may be explained by the fact that they all took their belongings



along,<sup>96</sup> a claim which we will encounter again in a similar manner in the next verdict handed down some eight years later.

Next the court refers to an actually existing document, the telegram of 9 June 1942 reporting the conclusion of the “action” (p. 154; see chapter 2.2.3.2.), which bears the defendant’s name. If genuine, it sure does not have any incriminating content either.

The defendant was finally sentenced to 6½ years imprisonment for two murders (the two hostages mentioned at the beginning) and aiding and abetting in the murder of some 7,000 people. So his strategy panned out at least partially: He blamed it all on the rotten corpse of the *Führer*.

### 3.7.3. From 1960 to 1964 (2 trials)

#### 3.7.3.1. LG Karlsruhe, Verdict of 20 Dec. 1961 & 13 Dec. 1963

During this trial eight defendants, only three of which were sentenced,<sup>97</sup> were accused for various (mass) homicides during their service for various German authorities in the eastern theater of war. Two of the defendants were successful with their appeals. The subsequent passages are from the first verdict, unless otherwise stated.

Most of the homicides dealt with during this trial concern shootings, which do not interest us in this context.<sup>98</sup> Regarding mass murder with gas vans, which the defendant Dr. Hans Schumacher was accused of having supervised in early 1942 and which he confessed to have done, the court writes:<sup>99</sup>

*“[The gas van] was a cuboid truck resembling a moving truck which could be sealed airtight and which could accommodate some 30 persons. By way of a dedicated device which was to be operated by the driver, engine exhaust gases could be led inside the van instead of to the outside. The occupants then died within a few minutes.*

<sup>96</sup> Since no other vehicle is mentioned, they probably took it along in the gas van. But compare chapter 3.7.4.8. about the same event, where a separate vehicle is claimed.

<sup>97</sup> Hans Schumacher & Reinhold Brünnert each to 4 years; the retrial against Erich Ehrlinger was first postponed but later shelved due to the defendant’s permanent unfitness for trial (appeal verdict, p. 629); see next footnote.

<sup>98</sup> Interestingly, the main defendant Erich Ehrlinger, head of *Einsatzkommando 1b* in summer 1941, “persistently” denied having ordered or participated in wanton mass murder, though the court did not believe him, pp. 85f., 106. Initially sentenced to twelve years, a retrial never took place due to him allegedly being permanently unfit for trial. Ehrlinger died in 2004 at the age of 95. So much for his unfitness; cf. [http://en.wikipedia.org/wiki/Erich\\_Ehrlinger](http://en.wikipedia.org/wiki/Erich_Ehrlinger).

<sup>99</sup> The verdict of the appeal merely copied this passage from the first verdict, p. 615.

[...] *When the inmates climbed into the gas van, they did not know what was awaiting them; Dr. Schumacher had told them that they would be resettled; hence they remained fully dressed and could also take their small possessions along. After they had climbed into the gas van, the doors were closed tightly, and still within the prison courtyard the exhaust gases of the running engine were led into the vehicle's interior. Soon thereafter the vehicle started to rock slightly; dull cries and knocking was audible. The inmates struggled for their lives. When all had turned silent after a few minutes and the vehicle had stopped rocking, this was the sign for the driver that the inmates were now dead. Now the gas van drove to its destination at the city limits, [...]. When opening the truck at the burial site, the corpses of men, women and children half stood, half lay in a disorderly manner and had distorted and disfigured faces, were soiled with vomit and excrements, visibly the signs of a painful death.*" (p. 100)

According to Dr. Schumacher, those gassings were only exceptions to the shooting rule, because "the atrocious corollaries of the gassings (unloading the corpses)" as well as the "emotional burden of the SS men who had to bury the victims" was unendurable (p. 103; appeal verdict: p. 618). This is interesting because the gas vans are said to have been invented in order to relieve the SS men charged with mass shootings from this burden. Just read what these men allegedly did instead of using the gas van for its intended purpose:

*"The inmates meant to be executed [...] had been loaded [...] onto a truck, whose cargo space was surrounded by a tarpaulin, or on a gas van temporarily used as a transport van. Then they were [...] driven to the execution site [...]. The inmates were led individually or in small groups [...] to the ditch, into which they had to lie down face down, in order to be shot by a member of the execution command with a shot in the neck. It thus happened frequently, that the subsequent inmates had to lie down on their executed, gory fellow sufferers, before they were all covered with dirt."* (p. 104; appeal verdict: p. 618)

Killing each human being individually at arm's length sure is a heavier emotional burden on everyone than killing a large batch anonymously in a gas van. Also, I cannot see why burying a gassed victim should be ghastlier than burying a shot victim. The former is less gory, for sure.

But emotional considerations aside, the real absurdity of this statement is the claim that most of the time the gas van wasn't even used as such. Instead, it served as a mere transport vehicle.

Hence I think this is just a defense stratagem by Dr. Schumacher to downplay the use of gas vans, since he must have felt that he could not deny them away. On his appeal he was sentenced to four years imprisonment.

Another defendant, referred to only as "P.," had invented a different tack to completely avoid punishment for an alleged execution, profiting from the above claim that the "gas van" usually served merely to transport inmates to the execution site:

*"It cannot be seen from the [execution] order that this time it was not to be implemented by shooting but instead by gassing. P. subsequently went to the prison courtyard in the early morning in order to drive with the loaded inmates to the execution site, as he thought. When he arrived at the prison courtyard, the last prisoners were about to be loaded into the gas van, which P. did not recognize as such; among them was also a woman, and when looking into the gas van he also recognized another woman and 2 little children of some 1 to 2 and 4 to 5 years of age. The driver closed the truck and drove it to the gate of the prison courtyard, where he stopped it. P, however, had entered a car standing on the road in front of the prison courtyard in order to follow the prisoner truck to the execution site, as he had done during the execution in April. Yet contrary to his expectation the prisoner truck did not come. After some 10 to 15 minutes had passed, P. left his car and went to the prison courtyard in order to find out why the truck was not coming. When he asked the driver there, he told him that the inmates had been gassed. The driver, whose name could not been found out, had run the engine on high speed for several minutes and had led the exhaust gases into the van's interior, after he had closed the van's door and had driven the truck to the prison's courtyard gate. Only then did the defendant P. realize that the special treatment happened by gassing this time and not by shooting."* (p. 118)

The court believed him. He was acquitted.

### 3.7.3.2. LG Koblenz, Verdict of 21 May 1963 & 10 Nov. 1965

During this trial eleven defendants were accused of various (mass) homicides, mainly by shooting and gassing in "gas vans," during their

service in *Sonderkommando* 1a and 1b of *Einsatzgruppe* A at the eastern theater of war, mainly in and around Minsk. They were sentenced to the following prison terms: life + 8, 15, 10, 8, 7, 3 × 4½, 2 × 4, 3½ years; five of the defendants were said to have been involved in gas van executions. Many of the defendants confessed.

The striking features of this verdict are its long passages dealing with the history of National Socialist anti-Jewish measures and the NS organizations implementing them. In this regard it is therefore a history lesson to the public rather than an attempt at clarifying certain alleged events. Again, some of the homicides dealt with are not said to have been committed with “gas vans,” so I will not address them here.

Regarding the deployment of “gas vans” in the Minsk area the court writes, obviously to a great degree based on the extant documents discussed in chapter 2:

*“Starting roughly in June 1942, gas vans were used for killings. The headquarters had three such vehicles at their disposal, one large Saurer truck and two somewhat smaller Diamond trucks. The Imperial Security Main Office, which also called these vehicles ‘s-vehicles’ (special vehicles) in its official writings, had devised these devices on the one hand in order to accelerate the mass killing, and on the other hand because it was feared that carrying out so many shootings would be too heavy an emotional burden for the assigned men. The gas vans were deployed only on the explicit order of the commander. They were entrusted to particular drivers, who had been prepared in Berlin for taking over these vehicles. The gas vans had a cuboid cargo box making them look like a moving truck. They were lined with sheet metal on the inside. A double door at the rear was the only opening. A foldout ladder facilitated the entry. [...] These [vehicles] were always loaded so densely that body stood next to body. This allowed up to 60 persons to be crammed into it. After the doors had been closed, the occupants were surrounded by complete darkness and airtightly locked away from the outside world. The gas vans then drove to the execution site and stopped next to the pit. Only then the extermination was initiated. The driver and his co-driver connected a hose and piped into the interior the exhaust gases of the engine, which was running only on low hand throttle. [...] the vehicle rocked forth and back for minutes, although this turmoil subsided slowly. After some 15 minutes the vehicle stood still.”* (p. 194f.)

With the exception of the foldout ladder, which is mentioned nowhere else as far as I know, this description of the “gas van” could probably be seen as a kind of “standard” in the sense that it shows the features most frequently referred to. Merely the claim that the gassing procedure was initiated only after arrival at the burial place is somewhat strange. That is precious time and in particular fuel wasted.

The court verdict discussed in the previous chapter quoted a defendant claiming that the gas vans weren’t used often because their method was so cruel and emotionally burdensome. Here we read the exact opposite. Yet here, too, a reason is given why mass shootings continued in spite of the existence of these vans, yet it is different than what we’ve heard before:

“[...] *frequent defects of the gas vans may have been the reason that they were not used continuously, so that Jews kept being shot.*”  
(p. 195)

Later on the verdict also claims bad soil conditions as a reason why the truck couldn’t approach the pit anymore, so the victims had to be shot (p. 268; 270), or that the gassing didn’t work at all, as the victims were merely unconscious (p. 270). Hence this verdict surmises as well that the gas vans were at times not used to gas people but rather to merely transport them to an execution site in order to be shot there (p. 197).

### 3.7.3.3. Interrogations of August Becker

In 1959, the West German authorities finally succeeded in tracking down the Chemist August Becker, the author of the infamous letter introduced during the IMT as part of 501-PS. Becker had apparently dropped out of sight since the war, as he had never been asked to corroborate his letter at Nuremberg or any other trials. No less than at least five German prosecution offices subsequently interrogated Becker: Gießen (28 Jan 1959; 26 March 1960), Düsseldorf (11 Jan. 1960), Hannover (28 Jan. 1960), Wiesbaden (4/5 April 1960, while hospitalized) and Stuttgart (20 June 1960).<sup>100</sup> Although the Internet encyclopedia Wikipedia claims that Becker was eventually sentenced to 10 years imprisonment,<sup>101</sup> there is no evidence to support this, as his name does not

<sup>100</sup> The dates are taken from Beer (1987), except for the one of 4/5 April 1960 and 28 Jan. 1959, which stem from <http://www.landesarchiv-bw.de/stal/grafeneck/index.htm>; Beer doesn’t list them, because these interrogations did not deal with gas vans.

<sup>101</sup> [http://en.wikipedia.org/wiki/August\\_Becker](http://en.wikipedia.org/wiki/August_Becker).

show up in any verdict of that time. Wikipedia also claims that he was released from prison on 15 July 1960 due to a stroke he had suffered, which sounds probable, as he suffered more strokes later on. Yet at that time he was probably only in investigative custody. When Becker was called as a witness during a later trial against defendants accused of having participated in the Third Reich's euthanasia program, Becker's mental health had deteriorated to such a degree that he was not even capable of testifying as a witness, as he could "hardly get a reasonable sentence together," as the German news magazine *Der Spiegel* reported (1967b).

The quality of Becker's statements of 1960 can be derived from the interrogation protocol prepared on occasion of Becker's interrogation of 26 March 1960, excerpts of which have been published by Klee/Dreßen/Rieß (1991), from which I will subsequently quote several sentences, followed by my comments (pp. 69-71):<sup>102</sup>

*"I was to pay particular attention to the mechanical functioning of these vans. I would like to mention that there were two types of gas vans in operation: the Opel-Blitz, weighing 3.5 tonnes, and the large Saurerwagen, which as far as I know, weighed 7 tonnes."* (p. 69)

If true, this sets the record straight about the alleged Diamond trucks used as gas vans, or any other make or model. According to this, Becker must really have known all the technical details of these gas vans. Unfortunately he was never asked to reveal any details about them during his many interrogations.

*"I thus left by train on 5 or 6 January 1942 traveling via Cracow and Fastov to Nikolayev. From there I flew in the Reichsführer's plane to Simferopol in the Crimea. [...] I reported to the head of Einsatzgruppe D, Otto Ohlendorf, sometime in January. I remained with this group until the beginning of April 1942 and then visited each Einsatzgruppe."* (p. 70)

Sure, little Becker fetches Heinrich Himmler's personal plane, which just happened to wait for him in the world metropolis of Nikolayev, and from there he flies around behind the Russian front inspecting the gas vans of the various *Einsatzgruppen*.

---

<sup>102</sup> Tellingly; the German Wikipedia webpage quoting excerpts from this testimony does not quote any of these passages, except for the last one, see [http://de.wikipedia.org/wiki/August\\_Becker\\_\(Chemiker\)](http://de.wikipedia.org/wiki/August_Becker_(Chemiker)).

*“At the same time I also learned from Potzelt that there was a Jewish extermination camp in Minsk. I flew to Minsk by helicopter, correction, in a Fiesler Storch [light aircraft] belonging to the Einsatzgruppe. Travelling with me was Hauptsturmführer Rühl, the head of the extermination camp at Minsk, with whom I had discussed business in Riga. [...]*

*When I saw what was going on in Minsk, that people of both sexes were being exterminated in their masses, that was it – I could not take it anymore [...].” (p. 71)*

When it comes to his mode of traveling, Becker’s fantasy lurks once again when he conjures up a helicopter. The “extermination camp in Minsk” probably refers to the Maly Trostinec camp 12 km southeast of Minsk. Orthodox historiography claims that some 40,000 to 60,000 Jews deported to Minsk from Germany, Czechia, and Poland were killed there *en masse*.<sup>103</sup> But Becker’s timing is off, as said deportations began only in early May 1942, so he could not have witnessed any of it.

Another problem with Becker’s statement is the alleged camp commander *Hauptsturmführer Rühl*. This person is probably identical with *SS-Hauptsturmführer Felix Rühl*.<sup>104</sup> However, Rühl was a member of *Einsatzgruppe D* which operated in the Ukraine and Caucasus, not in the Reichskommissariat Ostland, where Kiev was located. I have found no evidence that Rühl was ever stationed in that region, or that he had any connection whatsoever with Minsk or Maly Trostinec. Furthermore the Maly Trostinec camp was run by the Commander of the Security Police and the SD Minsk, not by the *Einsatzgruppen*.

Becker continues:

*“In a private conversation lasting about an hour I described to Pradel the working method of the gas vans and voiced criticism about the fact that the offenders had not been gassed but had been suffocated because the operators had set the engine incorrectly. I told him that people had vomited and defecated.” (Ibid.)*

“Offenders”? Is Becker implying that he thought the gas had been deployed to execute death penalties? I have already discussed the nonsense about distinguishing between “gassing” or “putting to sleep” and “suffocating” and about being able to manipulate the way the victims die by operating the engines in a certain way. This confirms merely that Becker has learned the content of this document by heart – he was

<sup>103</sup> [http://de.wikipedia.org/wiki/Maly\\_Trostinec](http://de.wikipedia.org/wiki/Maly_Trostinec).

<sup>104</sup> [http://de.wikipedia.org/wiki/Felix\\_R%C3%BChl](http://de.wikipedia.org/wiki/Felix_R%C3%BChl).

probably confronted with it numerous times during his interrogations, so he learned step by step what was expected of him, and he duly complied.

From these excerpts it becomes evident that Becker was really mentally confused. Mathias Beer, however, quotes Becker's various depositions eleven times in his 1987 paper, without even once hinting at their problematic nature.

### 3.7.4. From 1965 to 1969 (11 trials)

#### 3.7.4.1. LG Bonn, Verdicts of 30 Mar. 1963 & 23 July 1965

This trial was directed against eleven defendants who were former officials of the Chelmno/Kulmhof camp, where gas vans are said to have been the primary weapon of mass murder. It is therefore also one of the most detailed verdicts with regards to this question. Hence I will analyze it here more thoroughly than the other verdicts discussed in this chapter, whereby I will include Marais' 1994 observations.

After a retrial following an appeal of the first verdict, eight of the defendants were sentenced (3×13, 8, 7 years, 3×13½ months) and three exempted from punishment. None of the defendants denied the charges.<sup>105</sup> Most insisted that they thought they had to follow orders, and those who stated that they tried to resist claimed that such resistance had either been futile or that they thought their own lives would have been in jeopardy, if they had tried.

Although several defendants declared that they never had anything against Jews and actually got along with them pretty well before their deployment in Chelmno, these could just be claims. This is different with defendant B. (Heinrich Bock) who "got engaged to a Jewess in Berlin in 1940" at a time when such an act could and usually did have negative repercussion even for the non-Jewish partner in such a relationship. This proves, as the court stated, that he indeed "had no antipathy against Jews," and therefore considered "the killing of the Jews to be against morality and law." Yet still he obediently followed all orders (pp. 253, 291f.).

Another defendant (Me.)<sup>106</sup> even stated that his father, an opponent of National Socialism, had been arrested and severely mistreated by the

<sup>105</sup> One of them (Sch.) tried to commit suicide when first confronted with the charges, though, p. 258.

<sup>106</sup> Perhaps Kurt Meier; see [www.holocaustresearchproject.org/othercamps/chelmnoSSstafflist.html](http://www.holocaustresearchproject.org/othercamps/chelmnoSSstafflist.html).



Gestapo. Yet when Me. allegedly informed his father about what was going on in Chełmno, not even he “could give him any advice as to how to avoid this activity” (“Me.,” pp. 256f.). What a defense strategy! If not even staunch anti-Nazis had a solution, how can you sentence a son for not knowing what to do! I wouldn’t believe that story for a second, but it worked, and that’s what counts in a court room: “Me.” got off the hook.

If the extermination claims about Chełmno are true, the Nazi’s skills to make everyone, even their opponents, follow their orders blindly was quite remarkable indeed.

#### 3.7.4.1.1. Technical Details

The verdict of the first trial contains the entire text of the Just document (pp. 273-275; the letter’s first paragraph is quoted on p. 285). This set the rigid framework within which the “facts” could be established by the court.

*“The gas vans were large trucks painted grey of a foreign make [...]”* (pp. 230, 277)

The reference to a “foreign make” is consistent with other sources referring to foreign makes (Diamond, Renault, see chapter 4.2.2.). The most likely candidates for such vans, the German makes Saurer and Opel (Blitz) (see Becker’s statement, p. 189), were therefore allegedly not represented in the Kulmhof/Chełmno camp, where only up to three such vans are said to have been in operation.<sup>107</sup>

*The vans sported a “[...] closed cargo box, which was separated from the driver’s cab and was roughly 2 m wide, 2 m high and 4 m long.”* (*Ibid.*)

According to witness statements and the Just document, “nine to ten” persons per square meter were crammed into the cargo box. If we assume a packing density of 10 persons per m<sup>2</sup> and when assuming an average body weight of 60 kg (with a density of roughly 1 kg/liter), then these 80 persons weighing 4.8 metric tons filled up 4.8 m<sup>3</sup> of the total of 16 m<sup>3</sup> of available space. Under these circumstances each person had (11.2 ÷ 80) 0.14 m<sup>3</sup> (= 140 liters) of air volume at his or her disposal. Under these circumstances the victims would soon have been

---

<sup>107</sup> At times one of the three claimed Chełmno gas vans is said to have been a Saurer, although Mattogno has pointed out that the witness statements about the kind and number of gas vans allegedly deployed in Chełmno are not consistent (Mattogno 2011a).

suffocated due to the lack of oxygen without the need of conducting exhaust gases into the interior.

*“The interior [of the cargo box] was paneled with zinc-coated iron sheets. Wooden grates lay on the floor, under which pipes were located.” (Ibid.)*

This description of the gas van’s nonsensical internal piping is probably based on a testimony similar to that by Johann Haßler for the Minsk gas vans and other such descriptions as discussed before (see pp. 118, 130, 153), to which I refer the reader.

The verdict continues:

*“To the openings of the pipes at the van’s floor hoses were connected which had a conical tip.” (Ibid.)*

This sentence makes no sense. How can hoses have conical tips? And why would there have been several openings for connecting hoses? This implies that there were several independent pipes inside the cargo box, each with its own gas supply, which would have been a truly absurd design. This sentence does also not explain how these hoses were connected to these openings. Reason demands that the “pipes” (of the pipework) ended in just one opening in the floor, which was equipped with some (conical?) adapter, to which the hose could have been connected.

*“The end of the hose could be inserted into the exhaust pipe and screwed tight with a cap nut.” (Ibid.)*

If the hose was inserted into the exhaust pipe, it could not be screwed tight with a cap nut. Cap nuts press the end of a hose equipped with an end piece (with or without sealing) against the edge of a pipe. Exhaust hoses, on the other hand, are usually attached to pipes using hose clamps, not cap nuts.<sup>108</sup> This statement shows once more that the judges writing the verdict were not exactly familiar with technical issues like this, so that the witnesses could – and did – tell them whatever they liked.

Assuming that the hose was attached to the exhaust pipe with a cap nut, then the exhaust pipe must have had an outer thread, which is quite unusual, as exhaust pipes are usually too thin to allow for a thread to be cut into them. Hence it must have been equipped with a special, thicker end piece. It is also worth noting that the exhaust gases’ high tempera-

---

<sup>108</sup> See [www.esska.de/esska\\_de\\_s/schlaeuhe-schellen.html](http://www.esska.de/esska_de_s/schlaeuhe-schellen.html).

ture would have created difficulties to keep this thread operable due to fast corrosion, unless one had used special stainless steel.

It is furthermore striking that the two ends of the hose were not attached with the same technique: The one end was “inserted” into the exhaust pipe and fixed with a cap nut, whereas the other end had an ominous “conical tip,” with which it was attached to the pipe in the cargo box. Why complicate matters in such a way? Perhaps the connection to the box was permanent, whereas the one to the exhaust pipe was not, allowing for the hose to be detached, rolled up and stowed somehow underneath the cargo box? Apparently the judges didn’t care too much to find out how the hose was attached to the pipe opening.

The verdict continues:

*“The two wings of the door at the back of the cargo box opened to the outside and were equipped with a rubber sealing ensuring an airtight closure.”* (pp. 230f., 277)

No word indicates that the cargo box had openings enabling the escape of excess exhaust gases (for instance of the kind mentioned in the first paragraph of the Just document: two 1 cm × 10 cm slits). In fact, going to the trouble of using rubber seals to make the box airtight logically excludes the option of any openings. This confirms once more that the cargo box, in which the victims were said to have been locked, is said to have been sealed *hermetically*, which means that the exhaust gases must have exerted an ever increasing pressure on the interior of the cargo box. The description given for the way the hose was connected to the pipe opening or to the cargo box indicates that this connection must have been hermetical as well. Under these circumstances, the exhaust gases would have been piped into an enclosed space with a free volume of some 11 m<sup>3</sup>, so that it would have taken only a few minutes until the pressure would have risen to such a degree that the cargo box would have given way. Yet we are told that the operation took up to 15 minutes (see chapter 4.2.5. for the various alleged operation times).

#### 3.7.4.1.2. Operational Mode

*“Next the naked people had to enter the gas van. In each case it had been backed up by the driver to the openings of the ramp. After the wings of the door had been opened, the ramp was entirely closed up, since the ramp’s floor was at the same height as the floor of the gas van. While the Jewish people walked across the ramp, they were supervised by another police guard in addition to the accompanying*

*Pole and police guard. This guard was outside of the ramp next to the gas van, where he was to prevent escape attempts.*

*After the victims had entered the gas van, a Polish worker closed the door and usually also connected the hose stowed underneath the van with the exhaust pipe. The latter activity was sometimes also performed by the gas van's driver himself, who subsequently started the engine and gave a little gas.*

*The engine exhaust reached the van's interior through the hose. To those locked up inside, these exhaust gases consisting of carbon monoxide mixed with smoke and irritants caused headache, temporal pressure, nausea, vomiting and trembling. The victims realized what was happening. They got scared and panicked. This manifested itself in moanings and screams. They faced death and banged against the van's walls in desperation. After a suffering of several minutes, 7 to 8 minutes after starting the engine they became unconscious, and after another 2 minutes they were dead.*

*After starting the engine, the gas van's driver waited for some 10 to 15 minutes. Then the hose was detached.” (pp. 231f., 279)*

The latter is not easy at all! After ten minutes of operation an exhaust pipe is very hot, and it is not advisable to touch it with one's bare hands. In addition, a spanner, a wrench or a pair of pliers would have been needed to unscrew the cap nut from the exhaust pipe. The other end of the hose had to be detached as well for cleaning purposes – although it is not known how, as the type of connection is unknown.

*“After the Jewish workers had unloaded the corpses, they superficially cleaned the van's interior, which was soiled by the victim's blood, urine, and excrements.” (pp. 232, 279)*

During three later West German trials the expert “Prof. Dr. Joachim Ger.[chow]” of the Institute for Forensic and Social Medicine in Frankfurt testified about the effects of carbon monoxide poisonings, where he confirmed that vomiting, defecation, and urination can be an effect of such a death (Rüter *et al.* 1968ff., vol. 32, p. 99; vol. 37, p. 421; vol. 39, p. 613). That claim was confirmed by another expert witness, “Prof. Dr. Ste.,” who stated that these events usually occur after unconsciousness has set in (*ibid.*, vol. 39, p. 665). But it is unclear where the blood could have come from.

The verdict also addresses an explosion which is said to have occurred toward the end of May of 1942 in the *basement* of the Kulmhof

Castle,<sup>109</sup> and “exact circumstances of which can no longer be determined.” During that event the defendant “S.” (Alexander Steinke) is said to have been injured (pp. 240, 259, 326). The court conjectures that this explosion was identical to the one referred to in the first paragraph of the Just document (p. 285), even though a “gas van” parked in the castle’s court yard could not possibly lead to an explosion in the castle’s *basement*. The court made this forced parallel between the Just document and the eyewitness accounts in order to give both a higher degree of credibility by means of an alleged “convergence of evidence,” which, however, did not exist here at all. This is also visible from the court’s claim that, since the number of gas vans mentioned in the Just letter is the same as is said to have been deployed at Chełmno, the Just letter must be talking about these three Chełmno vans. However, the context clearly shows that the reference to the alleged explosion in Chełmno is set in contrast to the general use of these vans, so the author is talking about a general deployment of the vans and not just those at Chełmno.

Hence, and if considering the dubious nature of the Just document, whatever the Just document says about the number of vans deployed cannot really be used to verify the claims of other sources. It might be that this document’s claim of three deployed gas vans is the original source of the claim that three gas vans were used in Chełmno – or vice versa. But that would only prove a cross-fertilization from early witnesses to the document’s creators and then from the document to later witnesses.

The rest of the verdict consists of lengthy statements about the lives of the defendants as well as of the accusations and the reasons for the verdict. All this is of no importance to us, except perhaps of the following peculiar passage from the reasons given for the rejection of an appeal, which had been filed by the defendant Ernst Burmeister (p. 350):

*“The reading of German translations of protocols written in Polish about the findings made during an inspection of a so-called gas van as well as about the interrogation of the – meanwhile executed – deputy camp commander Piller was not a violation of article 249 of the Penal Law. Since the translations carry the attestation clause of a sworn court interpreter, whose signature is also certified by the court, they could be read without that their accuracy had to*

---

<sup>109</sup> Regarding Kulmhof/Chełmno one has to distinguish between the town as such, where Poles lived, the separate “castle,” and the “forest camp” some four km apart (Kogon *et al.* 1993, p. 75).

*be ascertained once more during the trial, be it by the interpreter or in another way [...]. Moreover the verdict would not be based on a potential violation: The design of the gas vans was undisputed; the jury court did not use the statements by camp commander Piller to the detriment of the defendants (verdict under B.III.2b)."*

Since this quote is about the deputy camp commander Piller, the relevant passage at the end of this paragraph B.III.2b ought to be mentioned here (p. 296):

*"Hence it has been ascertained that the statement by Piller is incorrect, wrongfully incriminating the defendant."*

I have analyzed Piller's sore-thumb "statement" about the valve-murder within two to three minutes already in chapter 3.6.2.2.

Regarding the inspection of a "so-called gas van," the alleged "findings" could have been challenged in court, but in that case neither the judges nor the defense lawyers were very curious and preferred to hide behind the text so that they did not have to challenge their own persuasions, even though the use of the adjective "so-called" may indicated that even the judges had their qualms. As I have quoted in chapter 2.1. (p. 33), this inspection of a "so-called gas van" did indeed come to the conclusion that this was *not* a gas van, hence the only thing this document introduced by the court should have served to do would have been to exonerate the defendants.

In summary it can be stated that this judicial text officially confirms a particular feature of the "gas vans" appearing in all witness accounts: These vehicles had a *hermetically sealed* cargo box. This would have been technically impossible, as I have pointed out in chapter 1.3.2. Already this fact should cause reservations about the eyewitness accounts. According to my knowledge no judicial authority has so far ordered an experiment being made to verify whether such a "gassing operation" would have been possible in the first place under conditions described by the prosecution.

#### 3.7.4.1.3. The "Explosion of Kulmhof"

This accident is mentioned in the first paragraph of the Just letter (see chapter 2.2.4.) and referred to four times in the court verdict under scrutiny. Neither document contains information about the cause of the explosion, but the claimed date of this alleged event enables us to come to revealing conclusions regarding the authenticity of this claim.

It goes without saying that this event, if it happened in the first place, must have occurred prior to the authoring of the Just letter (if both explosions are identical). Since the day on which this letter is claimed to have been written – the fifth of June 1942 – was entered by hand (presumably by the author),<sup>110</sup> it can be assumed that the document itself was actually written one day or even several days prior to the entry of the date. If considering the length of the document, which is a fairly detailed technical report, one may rightly assume that it is based on a manuscript whose drafting must have required some time. Since the author in Berlin could not possibly have learned immediately about this explosion in Poland, which during times of war was nothing extraordinary, one can safely assume that this explosion at Kulmhof/Chełmno must have occurred at the end of May 1942 at the latest, when considering all the necessary steps involved, as this hypothetical, but realistic inverse chronology shows:

- 5 June: signing of the letter;
- 3 June: typing of the letter;
- 1 June: start of drafting the manuscript;
- 28 May: reception of the news about the explosion;
- 25 May: explosion at Chełmno.

The verdict of the German court at Bonn states that the explosion at Chełmno occurred “at the end of May.” Hence both documents seem to agree on the time when the event is said to have occurred, and there is no *a priori* reasonable doubt as to the event’s reality, since the verdict mentions injuries suffered by one of the defendants (pp. 240, 259, 326 of the verdict).

I should mention here that Ingrid Weckert disagrees on this point. In a letter to P. Marais she wrote:

*“If the explosion had occurred only a few days earlier, then the news about it would not even have reached Berlin by June 5, let alone that someone had given ‘special orders’ to other ‘concerned departments.’ German red tape has never reacted that fast, and most certainly not during the war and at the RSHA, which had other pre-occupations. Hence the fabricated letter of 5 June 1942 was typed considerably later and by people who knew about the explosion. Since this was an internal affair, one has to look for the forger among this small group of people.”*

---

<sup>110</sup> This procedure can be found in other German documents of this era as well.

In order to assess the authenticity of the Just letter from that point of view, one has to determine by way of a careful analysis of this document whether the author could have known not only about the explosion at Chełmno but also about all the other information contained in the letter at the time when it was drafted.

In this regard I may add the following: The Just letter does not only prove that the author knew about the alleged explosion, but also:

- a) that the explosion had been assessed;
- b) that the cause of this accident had been determined;
- c) that special orders had been issued to prevent the repetition of such an accident in the future;
- d) that the orders had been implemented and tested regarding their efficacy;
- e) that this had led to a considerable increase in security.

I quote this passage once more from the letter:

*“The known explosion at Kulmhof has to be assessed as a single case. Its cause is to be ascribed to an operating error. In order to avoid such accidents, special orders have been issued to the offices concerned. The orders have been kept in such a way that the degree of security has been increased considerably.”* (emph. added)

Such a wording requires that considerable time had passed between finding out about the event, assessing its causes, devising remedies, issuing the order and the determination that the security had subsequently increased considerably, which is to say that a number of gassing operations must have been conducted in the meantime to ascertain this alleged fact. If we assume the reality of the explosion at the stated time – the court considered it to be a fact – the following things must have happened in Berlin, if we are to expect that the author of the Just letter really signed this document on 5 June 1942:

- a) immediate information about the accident, including a report detailing the causes for it;
- b) the causes were analyzed swiftly, and “special orders” were issued instantly for those operating the gas vans;
- c) rapid receipt of a confirmation by the responsible officers at Chełmno that the gassing operations (most likely a number of them) had run smoothly since the orders had been received;
- d) and finally drafting and typing a detailed technical report – i.e., the Just letter.



All this seems utterly incredible and hence proves in my view once more that the Just document was drafted and typed long after 5 June 1942 and was then antedated – always assuming the Chełmno explosion did indeed happen at the claimed time. Plus it must be emphasized that the author of the Just document changed the nature of the explosion, which the witnesses claimed to have occurred in the basement of the Chełmno Castle, by falsely bringing it into the context of a gas van operated outside the building.

Aside from the fact that the document itself gives rise to so many points of critique, this additional point does certainly not support its authenticity!

If the Just document is indeed a forgery, the fact that the date of the explosion at Chełmno is not mentioned in it is perhaps not without relevance, because this omission averts the risk that a reader insufficiently familiar with the details becomes suspicious due to the two dates being too close together. On the other hand: If the date of this accident is considered to be relatively well established, the question rises why the author has not avoided such critique right from the start by choosing a later date for the letter more consistent with the chronology of the events. I may surmise that either he did not know the exact point in time of this alleged explosion or that he probably didn't realize that the chain of multiple events involved would have delayed the typing of such a document much more than he had anticipated.

As to the reason for such an explosion, one can only speculate. If the explosion occurred in the castle's basement as claimed by the witnesses, then the gas vans could not have been involved. If positing that these homicidal gas vans were real and that it was an actual gas van that caused it (not in a basement, though), it could be that it was not really an explosion but merely a bursting of the cargo box as a result of an extreme pressure inside of it caused by it being hermetically sealed, as so many witnesses claim. However, if the vans' cargo boxes were hermetically sealed indeed, this bursting would inevitably have occurred already during the very first attempted gassing (*i.e.* in late 1941), after which pressure release openings would have been included *immediately* in all such vans in order to prevent such an event in the future – and not only after having processed “97,000” without any other problems, as the Just document claims. It would have been impossible to process even one person without such openings.

Another hypothetical cause for the explosion involving “gas vans” could have been that an explosive carbon monoxide/air mixture had developed inside the cargo box, which was ignited by some spark. But since this requires *at least* 12% carbon monoxide in the air,<sup>111</sup> such a value would have been unachievable with any unmanipulated combustion engine (the maximum value for a gasoline engine, reached while idling, lies at 10%; see Keeser/Froboese/Turnau 1930, p. 26; Matogno/Graf 2005, p. 124).

If, however, the vans in question were fueled by generator gas, whose fuel gas was explosive by definition, it is possible that such a gas generator exploded. This seems to be the only realistic explanation, although such an explosion would have had nothing to do with homicidal gassings.

But as I said, the witnesses mentioned an explosion in the basement only.

#### 3.7.4.1.4. Miscellanea

There are a few aspects of the verdict which are worth mentioning briefly. For instance, the threat of typhus epidemics was apparently a constant companion of those working in Chelmnó. In that regard, the verdict states:

*“In Posen [defendant Laabs] was inoculated against typhus, sworn to secrecy, and subsequently ordered to join the special command at Chelmnó.”* (p. 240)

*“The escorts and guard posts of the police obtained protection suits and an inoculation and were disinfested with Lysol. Yet in spite of this preventive measure, many police officials contracted typhus.”* (p. 281)

Although mentioned only in passing in the verdict, these events are a strong indicator that the inmates held in that camp or which passed through it had to undergo a similar treatment as well.

To prove his moral outrage about the alleged killing operations with gas vans, the defendant Laabs, who is said to have operated such a van, claimed the following according to the verdict:

*“Even if [Laabs], according to his unrefuted statement, was very terrified when he operated the gas van for the first time und subse-*

---

<sup>111</sup> The lower explosion limit of CO in air is 12 vol.%, a value far beyond what Diesel engine can emit and also beyond the normal operational range of gasoline engines; see [www.engineeringtoolbox.com/explosive-concentration-limits-d\\_423.html](http://www.engineeringtoolbox.com/explosive-concentration-limits-d_423.html).

*quently jumped out of the driver's cabin and 'shat in his pants', [...]."* (pp. 244, 290)

This puerile, probably invented story did not help him, though, as he willingly complied to perform all the later claimed gassings according to the court.

Laabs' alleged horrors are juxtaposed by the alleged reaction of another purported gas van operator, the defendant Walter Burmeister, about whom the court writes:

*"Conducting the gas van made such a little impression on him that today he does no longer know when he did it the first time."* (p. 247)

Or maybe he cannot remember because there is nothing to remember? Similarly calloused, according to the court, was the defendant Alois Haefele, about whom the court stated:

*"[...] not even today the defendant has a feeling of personal guilt [...]"* (p. 248)

So either he still thought during his trial that mass murder is a good thing to commit, or else he had no feeling of guilt because there was nothing to feel guilty about in terms of the indictment? The former would mean that the defendant was and is a human monster. Yet in this regard the court accepted that, while working at Chelmno, the defendant

*"prohibited the carrying of whips in order to prevent the guards from striking the victims, [...] he took care that the Jewish workers had sufficient food, occasionally gave them cigarettes, and on one occasion stopped the co-defendant Heintl from beating up the Jews."* (p. 249)

So he was definitely not a callous monster. But why would he then be utterly unrepentant about the crimes he committed or helped to commit?

Walter Burmeister, by the way, tried to rescind his pretrial testimony, in which he had admitted that he had operated the gas van, to the effect that he had merely driven the gas vans to the incineration pit after an unnamed Polish worker had attached the hose to the cargo box, had started the engine, and thus had performed the execution. Blaming that which was undeniable in the court's eyes on some anonymous Polish guy was too transparent a maneuver to be credible, so the court did not believe him (p. 299).<sup>112</sup>

---

<sup>112</sup> One of the witness during that trial was Sr[ebnik], who claimed, among other things, that the defendant Burmeister used dentist tools, incidentally found among the victims' property, to arbitrarily pull or break some of the witness's teeth merely in order to torture

## 3.7.4.2. LG Kiel, Verdict of 26 Nov. 1965

During this trial only one defendant was prosecuted for having been a guard in the Chełmno camp. The verdict only mentions the initial of his last name (F). The defendant was sentenced to 13½ months imprisonment for aiding and abetting mass murder. The term was considered served with the jail time the defendant had spent prior to the trial. A gas van is mentioned once in passing (p. 424) and described in more detail later (p. 429):

*“The gas van had a closed cargo box of ca. 4 m length and 2 m width and looked like a moving van or a refrigerator van. [...] It contained 70 to 80 persons, as results from a memo of the Imperial Security Main office of 5 June 1942 [Just letter] regarding technical changes of the deployed special vehicles and those in production [...]”*

This is followed by a quote from the Just letter including the reference to a packing density of 9 to 10 per m<sup>2</sup>. The verdict continues (p. 430):

*“After all victims [...] had been driven into the van, the airtight doors were closed by the Polish helpers. Then a hose was screwed onto the exhaust pipe, which led to an opening in the floor of the cargo box. The opening was covered by a grate. [...] Next the driver of the gas van, that is the witness Laabs or the driver Hering, started the gasoline engine of the vehicle and let it run at a certain rpm so that as much carbon oxide was produced as possible. [...] Only after 6 to 7 minutes the screams stopped, since the victims had become unconscious. To be on the safe side, the gas van driver let the engine of the stationary van run for some more 10 minutes, then removed the hose from the exhaust pipe and drove to the forest camp.”*

Hence, here as well the “truth” of the gas vans – for the court – had been cast in stone from the outset by the content of the extant documents produced during the Nuremberg trials, and everything else revolved around it.

Purely technically speaking, if indeed a van with a gasoline engine was used, then the scenario described was possible, since an airtight door doesn’t mean that the cargo box itself was airtight as well (although this may be assumed). We also have to ignore the minor detail of a hose being screwed to an exhaust pipe, which is technical nonsense.

---

him, an outrageous claim the court gullibly rubber-stamped as true, p. 300.

The gas vans allegedly deployed in Chełmno are said to have been of the “first group” (an expression used in the Becker document, see chapter 2.2.2.3.; cf. Beer 1987, p. 414), which entails that not all of them, if any, were Diesel-equipped Saurer trucks.

### 3.7.4.3. LG Wuppertal, Verdicts of 30 Dec. 1965 & 13 Dec. 1967

This trial concerned four defendants accused of having participated in mass killing operations of *Einsatzkommando 6* within *Einsatzgruppe C*, which operated in the north and central Ukraine. Some of these killing operations are said to have been conducted with a “gas van.” Some of the defendants claimed that they executed only criminals and partisans as well as their supporters, but the court did not believe them. One defendant was acquitted, while the other three were sentenced to 8, 5, and 3 years, respectively.

The verdict does not contain much information about the “gas van.” It merely states that it was “a 5 ton truck with a metal cargo box resembling a moving truck. The cargo box could hold at least 60 densely packed people and could to be entered from the rear through a large door. The engine’s exhaust gases could be introduced with a hose” (p. 513). Note that numerous sources speak of a wooden cargo box merely lined with sheet metal.

An attempt to kill the occupants of an insane asylum with an unnamed poison failed according to the verdict, because “either the doctors refused to administer the poison or because the poison turned out to have no effect.” I wonder which poison they picked so expertly that it had no effect. Anyway, the occupants were subsequently killed with a shot in the neck instead, an operation about which the court affirms:

*“Many of the victims went laughing and wildly gesticulating into their death.”* (p. 509)

That may be a child’s imagination of the occupants of an insane asylum, but highly educated judges should know better.

To close this case, there is also a little gem regarding the German concentration camps in the verdict. Since one of the defendants had repeatedly been severely drunk during his military service, he eventually got sentenced to 8 months. After he had served his time the following ensued in 1944:

*“Subsequently he underwent a rehab in the Buchenwald concentration camp.”* (p. 506)

This may not fit into the cliché the common reader might have about those camps, which merely indicates that this cliché is somewhat off the mark.

#### 3.7.4.4. LG Frankfurt/M., Verdict of 12 Mar. 1966

This trial against Adolf Josef Har[?], a former member of *Einsatzkommando* 8 (part of *Einsatzgruppe* B) deployed in the vicinity of the Belorussian town of Mogilev, initially ended with a prison term of four years, which was later revoked on appeal. A retrial mandated by the court of appeals never occurred.

Even though the defendant had merely been the manager of his unit's housing facilities, he was accused of having participated in several mass shootings of civilians (pp. 346f.) as well as in the gassing of some 600 prison inmates in a "gas van" (p. 349). About the gas van allegedly used by *Sonderkommando* 8 we read in the verdict:

*"It was a truck with coachworks resembling a moving truck which could be closed airtightly and in whose interior the exhaust gases of the engine could be piped by means of a hose connected to the van's exhaust system. [...] The gas van, which could hold some 50 to 55 persons, was mainly used to clear out prisons. At the prison's ramp the victims had to climb into the van's cargo box. The 'special vehicle,' as it was called back then, subsequently drove to the tank ditches outside of Mogilev. Here the hose leading into the van's cargo box was connected to the engine's exhaust system, and the engine was adjusted to 1,200 to 1,500 rpms. After some 8 minutes the engine was turned off and the cargo box was opened."* (p. 344)

The defendant admitted to his participation in several mass shootings while at once denying the extent of his involvement as claimed by the prosecution. He also insisted that he had not known the religious background of his victims, whom he considered to have been partisans or saboteurs (p. 349), a claim which the court rejected as untrue (p. 355). According to the verdict, the defendant's reaction toward gas van claims was as follows: (p. 349)

*"He also denies having supervised the so-called clearings of prisons, as such clearings are completely unknown to him. He claims to know nothing about a gas vans, he says that he has never seen such a van in Mogilev."*

The defendant was not alone in this lack of any knowledge. Although the court considered the existence and deployment of the gas van an immutable fact, it could not help but express its surprise about the complete ignorance of many witnesses in this regard: (pp. 356f.)

*“It was striking that many witnesses knew nothing about the existence of the gas van. Even the witness Ric.[chter], during whose time as leader of the Einsatzkommando 8 the gas van had been deployed, stated that he found out only during the interrogations that there was a gas van in his detachment. The witness Ste., who otherwise gave detailed statements, knew nothing of a gas van either.”*

The verdict discusses in detail the court’s difficulties to refute the defendant’s claims, as the only evidence against him was other witness testimony. With a lot of healthy skepticism, which is rare among judges dealing with such cases, the court argued why it could not rely on many of these witness testimonies:

*“During the interrogation of witnesses, difficulties resulted primarily from the fact that the witnesses’ memory has faded substantially – the events about which they had to report are now already 24 years ago. [...]*

*Another difficulty was that the majority of witnesses heard by the court have been interrogated repeatedly during the past years in several investigation and penal cases – in one case thirty times. It lies within the nature of the matter that the witnesses are confronted with claims during these interrogations, so that in the course of time a witness can no longer distinguish knowledge based on his own experience from knowledge based on what he has learned later on.”*

Needless to say that this is true for the majority of the trials conducted after the war – the more so, the later they took place.

Due to these and other “insurmountable difficulties,” many of the defendant’s claims could not be refuted with certainty.<sup>113</sup>

In this context it is interesting to note that the existence of several gas vans is documented for *Sonderkommando 8*, see chapter 2.2.8. (provided the document is authentic). As described there, it is by no

---

<sup>113</sup> The verdict’s revocation by the court of appeals was based on a technicality: Since the verdict had mentioned that the defendant had considered the execution orders he had received as legally binding, the court had to either acquit the defendant for “mistake of prohibition” or refute his claim.

means clear, though, whether these vehicles served the purpose of mass murder. They may just as well have been simple producer gas vans.

### 3.7.4.5. LG Hannover, Verdict of 7 June 1966

This trial is probably the most interesting from the point of view of our research topic, because the defendants are said to have been the individuals in charge of designing and building the “gas vans:” August Becker, the author of the infamous Becker letter, Friedrich Pradel, whose signature or initials can be found on some of the documents investigated here, and Harry Wentritt. Since August Becker had suffered several strokes by 1966, he was declared unfit for trial and incarceration (see chapter 3.7.3.3.). The German newsmagazine *Der Spiegel* (1966) described Pradel’s case as follows:

*“The old Sturmbannführer’s eyes are welling up. ‘Your Honor’, he sobs, ‘I really have no knowledge about exterminations of Jews.’*

*The former SS man currently sitting in the dock of the Jury Court in Hanover is accused of aiding in 6,000 cases of murder. According to the indictment, Friedrich Pradel, 65, once head of the motor vehicle department II D 3a of the Imperial Security Main Office (Reichssicherheitshauptamt, RSHA), is said to have arranged for the construction of at least 13 mobile gas chambers and to have sent them from Berlin to their deployment in the east.*

*Also on trial is the man who mounted the killing utensils into the gas vans as the head of the RSHA car repair shop: the former SS-Untersturmführer Harry Wentritt, 63. [...]*

*Pradel claims not to have known that the ‘97,000’ who were systematically killed without a verdict were Jews: ‘I thought persons sentenced to death would be executed in the vans – that is to say captured partisans and maybe also soldiers of enemy armies.’ And whiningly enraged: ‘But Jews –, no, never.’*

*Pradel could also not remember the telegrams in which SD Einsatzgruppen, with explicit reference to ‘new transports of Jews,’ requested more gas vans from his department or – as the commander of the security police in Minsk did on 15 June 1942 – requested ‘to also send ten [correct: 20] exhaust hoses, since the existing ones are already leaking.’*

*But Pradel can at least remember the purpose of the gas vans: ‘It was meant to be a more humane kind of execution,’ he says reluc-*



tantly. *Question of the judge: 'More humane for whom – for the executees or for the execution commands?' No answer.*"

The "97,000" mentioned by *Der Spiegel* refer to the number mentioned in the Just document, whereas the "telegrams" mentioned refers to only one such document dated 15 June 1942, see Appendix 3.

During the court investigations leading up to this trial, Wentritt stated the following during an interrogation (Kogon *et al.* 1993, pp. 53f.):

*"A removable exhaust hose, which led from the outside to the floor of the van, was fixed to the exhaust [pipe]. We bored a hole in the van about 58 to 60 millimeters in diameter, the size of the exhaust pipe. Over this hole, to the inside of the van, was welded a metal pipe, which was attached to, or could be attached to, the exhaust hose that came from the outside. When the engine was switched on and the connection made, the engine's exhaust fumes went through the exhaust pipe into the exhaust hose and from there into the pipe that led to the inside of the van. Thus the van filled with gas. Pradel did not go into further details; in any case, that's all I can remember now. He gave instructions to fix the vans in such a way that the engine exhaust fumes could be introduced into the van. This was possible with the help of the hose that was attached to the exhaust. Pradel then told me that another pipe had to be fitted inside the van to prevent the occupants from interfering with the admission of the gas. Thus the work carried out by our motor pool was essentially determined by Pradel or his superiors."*

Wasn't Wentritt the guy whose workshop was to do the work? Then why would "all [he] can remember" be merely what Pradel had told him?

Although it makes sense to secure this gas inlet spot from interventions by the occupants, it is unclear how this could have been done with "another pipe" "fitted inside the van." Maybe Wentritt refers to a long horizontal pipe underneath the floor grid sporting numerous small holes. However, considering that the floor grid would have prevented the victims from interfering with the inlet holes, such a device would have been quite superfluous. Without such a floor grid, however, any pipe within the reach of the victims could have been interfered with by them.

At the end of this trial Pradel was sentenced to seven years imprisonment for aiding in the murder of at least 6,000 persons, whereas Wentritt received only 3 years.

In the verdict we read the following about the reason why “gas vans” were invented in the first place (p. 615f.):

*“The members of the Einsatz- and Sonderkommandos could not bear the moral burden [of mass shootings]. Many of them were family fathers themselves who had a particularly hard time shooting women and children. Drinking excesses, insubordinations and serious mental disorders are said to have occurred.”*

About how they were devised, the verdict states (p. 616):

*“At that time gas vans were already known and had been tested in practice, because already during the so-called euthanasia action mobile gas chambers had been deployed for the extermination of mentally ill persons allegedly unworthy of living. These were trucks with airtight cargo boxes, into which the sick persons were led and where they were killed by means of chemically pure carbon monoxide drawn from steel bottles. The gas vans subsequently planned were to differ from that only by introducing into the vehicle the poisonous engine exhaust gases containing carbon monoxide instead of the chemically pure carbon monoxide from steel bottles. This had the advantage that the expensive transport of the bottled gas could be omitted, which would have encountered difficulties especially in the spacious eastern territories.”*

Allegedly asked by his superiors to solve the technical issues involved, the defendant Wentrutt is said to have responded (p. 617):

*“The exhaust pipe merely has to be cut open and a T piece inserted. Then it is possible without difficulties to introduce the gas from the exhaust pipe into the van’s interior.”*

Let us consider this for a moment. An exhaust pipe ends in the open. In order to *insert* a T piece, the pipe would get cut off, the T piece inserted, and then the cut-off piece would be re-attached to the other end of the T piece. Technically seen, this is nonsense. If you want to have a T piece in an exhaust pipe, just *attach* it to the end of the exhaust pipe, not *insert* it. Furthermore, a simple T piece wouldn’t have done the trick, as the gas, following the path of least resistance, would have escaped from the tailpipe into the open rather than flowing into the cargo box. Piping the gas into the box would have required the closure of the other exit of the T piece.

This account resembles the nonsensical statement by witness Johann Häbler (see p. 152). Both tried to sound convincing by describing a specific technical detail, but neither seems to have realized the nonsense

they were saying. They should have stuck to the mainstream story of simple metal hoses attached to the tail pipe.

Another rather astounding claim can be read on the same page:

*“When the defendant Pra.[del] received the order from Rauff to construct the gas van, he realized immediately that these vans were also meant to be used for the mass extermination of the Jews for racial reasons.”*

This is said to have happened in September 1941, at a point in time when no decision about the “final solution” had been made yet and no systematic mass extermination was happening, even if we follow most mainstream historians’ point of view.<sup>114</sup> How Pradel could have known something which wasn’t even decided yet by the German government – if it ever was – is a complete mystery. In this context it is therefore important to note that this claim by the court is based on a statement Pradel made during interrogations in 1961 and 1962 while in pre-trial detention, four to five years prior to the trial (pp. 639f.). During the trial itself, Pradel turned around 180° when he stated, as quoted by the German newsmagazine *Spiegel* (see p. 207):

*“‘Your Honor’, [Pradel] sobs, ‘I really have no knowledge about exterminations of Jews.’”*

The verdict confirms this when it summarizes Pradel’s statements during the trial as follows (p. 638):

*“The defendant Pra.[del] has stated that, when he had received the order to build the gas vans and had forwarded it to Wen.[tritt], he had not known that the mass extermination of the Jew was to be implemented with this. He claims to have learned about this only after the war. He had thought instead that the gas vans were to be used during the execution of partisans properly sentenced to death.”*

It goes without saying that the court believed what the defendant said while in pre-trial detention. This cannot have been the case because Pradel’s earlier statements were more convincing – historically seen they cannot be convincing – but because they fit into the dogma. The situation is similar with regards to the other defendant (pp. 641f.).

On page 615 the verdict quotes an absolutely incredible passage from one of the action reports of the Einsatzgruppen:

*“In action report no. 128 of 3 November 1941, Einsatzgruppe C (of leaf 3 and 4): Even if so far a total of 75,000 Jews have been liq-*

<sup>114</sup> The decision to prevent Jewish emigration and to deport them to the east (whatever that meant) was only made in late October 1941; see Rudolf 2010, p. 141.

*uidated in this manner, it is clear already today that a solution of the Jewish problem will not be possible. Although we managed to effect a complete resolution of the Jewish problem in smaller towns and also in the villages, in larger cities we always observe that, if a commando returns after a certain period of time and although all Jews have disappeared after an execution, a number of Jews is over and over again encountered which exceeds the number of executed Jews considerably.”*

This is the Nazi paradox of mass murder: the more Jews the German units executed, the more of them emerged out of nowhere... Considering that the German units are said to have been highly “successful” in eliminating the Jewish population in the occupied Soviet territories, such a remark is not only logically impossible, but must also be wrong, if the predominant orthodox historical school is correct. While this document proved the mass murder in the eyes of the court, it sheds a revealing light on the credibility of the creator of the documents in my view.

Another revealing passage from the verdict sheds a similar light on the careless manner in which the court determined what it considered to be true. On page 619 the verdict discusses how the defendants managed to procure their first five trucks for conversion into “gas vans.” Although orthodox historiography maintains that the first trucks were trucks of the U.S. company Diamond, that’s not what the court came up with. In it we read:

a) Pradel claimed that he tried – in vain – to obtain trucks from the witness Bal.

b) The witness Bal. had no recollection of ever procuring trucks for Pradel.

c) Next Pradel claimed that Walter Rauff himself procured five rusty Saurer trucks from the head of the SD’s motor pool, the witness Ga. These trucks were inspected by Pradel and Wentrutt in the courtyard of the SD in Berlin.

d) The defendant Wentrutt, however, had no recollection whatsoever of this alleged event.

e) The former head of the SD motor pool, witness Ga., as well as his staff member, witness Heinrich M., could not recall such an event either. According to them, the SD only once had three or four superfluous trucks (of the Büssing company, according to witness M.), which were

modified to serve as radio trucks. They themselves had seen such a radio truck after its conversion.

What would the critical historian make of this hodge-podge? The court wasn't bothered by this muddle, though, and simply mandated (p. 619):

*"It has remained unclear who organized and delivered the five trucks for the construction of the gas vans. Due to the statements of both defendants the Jury Court is convinced, however, that it is certain that these five Saurer trucks were present on some day in the fall of 1941."*

Not because the evidence says so, but because the dogma cannot be upheld without it.

The court continued as follows (*ibid.*):

*"Both defendants together visited the vehicle company Gaubschat Ltd. in Berlin during the fall of 1941. There Pra.[del] discussed the possibility of equipping the 5 ton vehicles with an airtight cargo box. Due to the ordered secrecy he gave as a reason that the vehicles were to be deployed for the removal of corpses in case an epidemic loomed."*

But was it really a ruse to fool the Gaubschat staff, or a mere lie to assuage the relentless interrogators and judges?

*"Initially the Gaubschat company built only one vehicle as a prototype by equipping one of the five Saurer vehicles with a roughly 2 m high airtight cargo box, which had a fixed, high-domed roof of the type of railway freight cars. It had a double-leaf door at the rear opening outward for loading. On the inside the box was lined with sheet metal, and in its upper corners it had lights protected by iron screens. The floor was covered by a wooden grate. The driver's cabin, equipped with the usual two doors, was detached from the cargo box. On the outside the vehicle, which had a length of four to five meters and a width of some 2 meters, was painted field gray. In that way it looked like a large moving truck." (Ibid.)*

As can be derived from the Gaubschat documents, the cargo boxes built by that company were actually only 1.7 m high, not 2 m (in order to allow for railway transportation of these vehicles), and from this we have to deduct the height of the wooden grate, so we end up with a free height of maybe 1.6 m or less (if taken into consideration the pipes allegedly lying beneath the grate, see below). In addition, the Gaubschat cargo box alone was 5.8 m long, which would have resulted in some 8+

m for the entire vehicle, not 4 to 5 m. Although the court was in possession of these documents (as results from the verdict, pp. 621f.), they seem to have taken from it only what fit into their preconceived notion.

The high, vaulted roof described in the verdict is a new feature unheard of so far and not exactly common for moving trucks.

Regarding the conversion to a gas van, the verdict states, based on statements made by the defendant Wentritt (pp. 619f.):

*“He cut the exhaust pipe open and inserted a T-piece into it. Then he drilled a hole of some 50 to 60 mm into the floor of the cargo box, through which he inserted a connector piece. This connector piece was welded [to the floor], and inside the cargo box a U-shaped pipe system was connected to it, sporting small holes in regular distances. All that was needed now in case of necessity was to make a connection with a screwable hose between the T-piece in the exhaust pipe and the connector piece in the floor of the cargo box, both of which had threads. It was then possible to conduct the exhaust gases without difficulties through the connector piece into the pipe system and from there into the truck’s interior.”*

Without difficulties – except that without a cap or plug the gases would have escaped out of the tail pipe instead of taking a 90° turn and streaming out of the small holes of the U-shaped pipe system – a complicated device as useless as tits on a boar.

The next step in the expertly planned and executed construction of these vans was their testing, about which the court writes:

*“After he had done his work, the defendant – as he admitted – brought the vehicle [...] personally to the Institute for Criminological Technology in Berlin [Kriminaltechnische Institut, KTI]. There a chemist performed a gas analysis by putting a measuring device into it for a longish period of time while Wen.[tritt] let the engine run. The defendant Wen.[tritt] did not learn anything about the results. Even the witnesses Dr. Lei.[ding], and Dr. Hof.[fmann], whose position and assignment within the KTI has already been described, have reported about the gas analysis [...]. Dr. Lei. himself performed it in the courtyard of the KTI. The description of the gas van given by these two witnesses matches the Saurer prototype converted by Wen.[tritt].”*

This is all very impressive, with the one catch that all Saurer trucks had Diesel engines; hence their exhaust gases while idling in some

courtyard would never have resulted in dangerous levels of carbon monoxide.

We need to keep in mind that the KTI wasn't just some institute. Remember Q, the quirky inventor of gadgets in the James Bond movies? That's the type of people we would expect in such an institute in a nation that during those years was leading the world technologically. They knew what they were doing. And they knew that exhaust gases of idling Diesel engines would not kill anybody. So why did all those doctors of crime technology testify otherwise?

Whereas there is documentary evidence about the existence of 30 Saurer trucks for some unknown special purpose, no such evidence exists about the procurement and conversion of the wraithlike Diamond trucks (or Becker's Opel Blitz, or Burmeister's Renault, etc.) – apart from the mere claims by the defendants that they existed, although they couldn't explain who delivered them and who had converted them (p. 621).

The court subsequently summarizes a number of statements by witnesses claiming to have driven such gas vans. The most striking example of the statements quoted, and the one revealing the circumstances under which those witness statement came into being, is the following (p. 626):

*“The witness Gne. committed suicide in the pretrial detention center Berlin-Moabit on 20 July 1961 by hanging himself. In his unsworn affidavit which was read by the Jury Court he confirmed having transferred a Diamond gas van together with Ge. from the Imperial Security Main Office in Berlin via Riga to Minsk [...].”*

Hence an unsworn statement by a man who had committed suicide five years earlier *due to the situation that made him write this statement* was used as evidence during this trial.

On the same verdict page we read what two other “voluntary” witnesses claimed “independently” from one another that they had arranged for a gas van to be sent back to Berlin for repairs in order to make sure that the cargo box was airtight! (A Diamond truck in one case, a Saurer in the other.) The defendant Wentrutt denied having received those trucks in Berlin and having made any such repairs, but the court didn't believe him. However, no gas van with an airtight gassing box could function, so the witness's story is false, plain and simple. This nonsensical statement was obviously copied from the 4th para-

graph of the Becker document's equally nonsensical consideration to transfer leaky vans to Berlin for repairs (see p. 45).

The rest of the verdict consists mainly of speculations about the total number of victims of these alleged gas vans at each of their location of deployment, based on a number of witness statements and documents. Although certainly interesting from a historical point of view, these considerations do not contribute anything new to our understanding of the matter at hand.

#### 3.7.4.6. LG Stuttgart, Verdict of 15 Sep. 1967

Albert Widmann was a Chemist at the German Institute for Criminological Technology in Berlin (*Kriminaltechnisches Institut*, KTI). In 1939 he received orders from Arthur Nebe, then head of the Reich Police Department for Criminal Investigations (*Reichskriminalpolizei*amt), to find a poisonous chemical which could be used to kill severely mentally disabled individuals in the course of the euthanasia program. He settled for bottled carbon monoxide. Later he is said to have gotten involved in the development of "gas vans" as well. In 1967 he was tried on both accounts by the Stuttgart District Court. The German news-magazine *Der Spiegel* reported about this trial (1967a):

*"In the fall of 1941 the expert [Widmann], who meanwhile had become the head of the chemical department of the KTI, was ordered to a mission in the east in order to develop 'other killing methods' as a relief for the SS execution commands. Widmann traveled with eight centners [400 kg] of explosives, two metal hoses and two vehicles into the area of Minsk to experiment in murder.*

*The first attempts were disappointing. 25 mentally ill people were locked into a shelter, which had been prepared with explosives; Widmann gave the sign for the explosion and also operated the ignition device himself. Each time corpse fragments whirled through the air and got stuck in the trees. This procedure was unsuited for mass murder."* (Similar, but more detailed: verdict pp. 561f.)

We can take for granted that Widmann has developed an efficient method for killing people at the beginning of the euthanasia action in late 1939 – bottled carbon monoxide (verdict p. 559). It's been tested and foolproof. In late 1941 he was allegedly asked to help jump-start a similar program in Minsk. Instead of giving those Germans in Minsk a simple advice like: "If you don't have bottled gas, take it from your wood gas generators," he instead traveled 2,000 miles to get himself in-



volved. Even Widmann's interrogator was doubtful, as he asked him whether such a single experiment would have justified such a journey (Friedlander/Milton 1993, p. 483). For some incomprehensible reason, however, he thought he couldn't take along a bottle or two of carbon monoxide or a wood gas generator. But taking along 400 kg(!) of explosives on this long journey was no problem and was also indispensable, since, after all, the German army in the east had no such thing as explosives. Maybe they were fighting their war against the Red Army with hammers and sickles...

Instead of putting his two exhaust hoses to "good" use in Minsk right away, though, those smart Germans decided to blow up a few mentally ill people instead using several hundred kilograms of explosives, even though a few kilograms, properly arranged, would have sufficed completely. Hence, already the sheer amount of explosives said to have been used proves beyond doubt that the inventors of this story didn't know or didn't care what they were talking about.

And surprise, surprise: this method turned out to be a bloody mess! But since not all people had died with the first round of dynamite, they allegedly blew them up a second time, only to find corpse parts scattered all over the surrounding trees.

Widmann even attended a conference, during which the results of this experiment were analyzed (Friedlander/Milton 1993, p. 483):

*"During the conference with Nebe we reached the conclusion that, although killing with explosives 'occurs with a jerk,' it was not feasible due to the comprehensive preparatory works; in addition also due to the large amount of work in context with filling up the explosion craters."*

– not to mention picking up the intestines from the tree branches over there... (similar the description in the verdict, p. 563.)

Who were the mentally sick people here? The alleged victims, Widmann and his colleagues, the journalists from *Der Spiegel*, the prosecutors and judges during this trial who repeated this nonsense, or the orthodox historians who parrot it without twitching an eye?<sup>115</sup> Or maybe all of them?

---

<sup>115</sup> Excerpts of it have been quoted by Krausnick/Wilhelm 1981, pp. 548-552, without any critical comment; the curious reader may read this nonsense online at [www.nizkor.org/ftp.cgi/people/ftp.py?people//w/widmann.albert/Sentence-on-A.Widmann.txt](http://www.nizkor.org/ftp.cgi/people/ftp.py?people//w/widmann.albert/Sentence-on-A.Widmann.txt); when quoting Widmann, Kogon *et al.* 1993, p. 52f., seem to have been at least dimly aware of the nonsense, hence they mention the explosive experiment only in passing.

This absurd story reminds me of the memoirs by former Auschwitz commander Höß, who, after months of torture and imprisonment, had claimed that attempts were made to make corpses disappear by blowing them up, which, needless to say, didn't work out too well (Broszat 1958, p. 159). In this context I may also refer back to a survivor of the Chełmno camp who came up with a similar story of mass murder by blowing up a building (see chapter 3.6.3.1.).

The explosive story reported by *Der Spiegel* astonishingly stems from the defendant himself, who concocted it during an interrogation seven years prior to the trial (Friedlander/Milton 1993, pp. 477-480; subsequent page no. in this chapter from there, unless indicated otherwise). Reading this interrogation makes one think that Widmann was pulling the interrogator's legs. He claimed, for instance, that prior to their departure one of his colleagues had asked "the air force" to find out, how many explosives they would need to obtain the intended result. Why the air force? What do they know about blowing up people in wooden sheds? In fact, any air force officer confronted with such an inquiry would most likely have given the closest insane asylum a call, asking for a straightjacket. Next Widmann claims that they had trouble getting the explosives and that at the end they bought it from a company in Berlin (pp. 477f.). Well, next time I am in Berlin I'll stroll into an explosive factory as well and buy 400 kg TNT. Why not? Bomb shopping is my favorite pastime!

Widmann also tells us the gripping story how his superior had come up with the idea of killing by means of exhaust gases (p. 478):

*"With Heess there has also been talk about using gas to kill the mentally ill [...]. I assume that Heess had talked about this already earlier with Nebe. That must have been around the time when Nebe – as Heess had told me back then – had dozed off in his car in the garage with the engine running and almost had died, if one is inclined to believe his tales."*

Yes, if...<sup>116</sup>

Widmann subsequently tells the tale about preparing the wooden sheds for the fireworks, but claims that he had seen no victims (or parts thereof) either before, during, or after the explosion (pp. 479f.). That was probably meant to be his emergency exit out of being held responsible.

---

<sup>116</sup> The LG Hannover called this story a "rumor," verdict of 7 June 1966, p. 616.

There is another problem with the explosive story, an internal inconsistency which the Stuttgart court itself pointed out (verdict p. 565):

*“Because at that time gas vans were already known and field-tested. Already during the euthanasia action mobile gas chambers which looked like company vans of Kaiser’s Coffee Shop were deployed for the extermination of allegedly severely mentally sick persons in the General Government in Poland. These were vans with an airtight cargo box, in which the sick persons placed in it were killed by means of chemically pure carbon monoxide taken from steel bottles”*

If that is so, and if Dr. Widmann was as deeply involved in the development of killing methods for the euthanasia action as is claimed, why would he have seriously considered killing mentally sick people with dynamite two years later?

Widmann also claimed that he did use those two exhaust hoses a little later in the Belorussian town of Mogilev. For this they “sealed” a room of a mental asylum by walling up a window – yet a second window was left intact for the victims to smash (?) – and then they added two openings into a wall. After the victims had been locked up in the room, exhaust gas from a gasoline car was piped in via one of the holes – with no success after 5 minutes. Then, in addition to the car, the tail pipe of a “transport vehicle belonging to the regular police” was hooked up to the second hole – this time with success after another 8 minutes (p. 482; verdict, pp. 562f.). There is a problem with this story:

1) The car’s exhaust gases would have been swiftly lethal; if the police vehicle was an Opel Blitz with a gasoline engine, its exhaust volume could have sped up the process; if the vehicle had a Diesel engine, the intended victims would have gotten tortured instead.

2) The second hole in the wall would have been needed for excess gas to escape. Plugging it would have led to problems.

Widmann also spread the lie that crematorium chimneys – in this case of a hospital – can spew “5 m high flames” (p. 484). This legend has been thoroughly debunked by C. Mattogno (2004c).

The verdict describes the gas vans as delivered by Gaubschat and the changes allegedly made by Widmann in an almost identical way as the verdict of the LG Hannover of 7 June 1966 (see previous chapter, pp. 212f.). Both verdicts obviously based their descriptions on the same witness statements and declarations of the defendants, and from the wording itself (p. 566) it seems that the Stuttgart judges even copied

passages of the Hannover verdict. Regarding an analysis of this description I refer the reader therefore to the previous chapter.

An article by the local newspaper *Stuttgarter Nachrichten*<sup>117</sup> quotes the witness Paul Werner, a wartime superior of Widmann, as having “consciously heard” about the “gas vans” only after the end of the war, just like Widmann insisted that during the war he never heard anything about Jews being killed in gas vans, although he admitted to have known about their existence. He claims to have thought that this was just an extension of the euthanasia action. He also admitted having performed gas analyses of the air inside such a “gas van” in action. The verdict writes about this (pp. 567f.):

*“In the spring of 1942, possibly already in January 1942, the defendant, who by then knew about earlier gas analyses, and his coworkers received the order from Dr. Heess to once more perform measurements and gas analyses at a gas van located in the courtyard. [...] The purpose of these gas analyses was to either determine the time needed to obtain an absolutely lethal CO content of 1% in the cargo box, or whether an explosive gas mixture develops inside the van due to the exhaust gases piped into it (because such a van had exploded in Kulmhof in spring of 1942). Due to the measurements and gas analyses performed by the KTI and the technical works of the automotive department D 3a, the first Saurer vehicles were operable around January 1942.”*

Here we have another court reference to the explosion in Kulmhof/Chełmno, this time even with cause given: the concentration of carbon monoxide inside the cargo box had allegedly risen beyond the lower explosion limit of 12%, although this value is unachievable with Diesel engines and extremely unlikely with gasoline engines. Also, if Widmann was indeed ordered to do measurements as early as January 1942, the Chełmno explosion must have occurred at the beginning of January 1942 at the latest, and not in May as the Bonn court had claimed.

Widman, by the way, gave a different reason for taking gas samples inside a standing “gas van” with an idling Diesel engine: he claims that this was made in order to find out when a lethal content of 1% carbon monoxide in the air was reached (Beer 1987, p. 411) in order to ensure a swift execution. With exhaust gases from an idling Diesel engine,

<sup>117</sup> Newspaper article of the *Stuttgarter Nachrichten* posted at [www.landesarchiv-bw.de/stal/grafeneck/grafeneck08b.htm](http://www.landesarchiv-bw.de/stal/grafeneck/grafeneck08b.htm) (probably 16 March 1967).

however, this value would never have been reached. Interestingly, Widmann also stated that “the gas analysis did not have a useful result,” a claim the court did not believe (verdict p. 570). When keeping in mind that an idling Diesel engine would never have resulted in any “useful result,” this statement might actually be the only credible part of Dr. Widmann’s confession.

Considering that Germany was (and still is) one of the world’s leading nations regarding science and technology, it must be assumed that a very high technological standard also prevailed in the RSHA’s Institute for Criminological Technology, to which Widmann belonged. Yet when reading Widmann’s testimony, one is struck by the massive disorganization, ridiculous incompetence, and gross carelessness reflected by these men. This is irreconcilable with what has to be expected by such a German institute. In other words: Widmann’s testimony is totally unbelievable, and he is utterly discredited as a witness.

Widmann was eventually sentenced to 6½ years imprisonment, which is a joke, considering his claimed deep involvement in mass murder.

#### 3.7.4.7. LG Stuttgart, Verdict of 11 June 1968

The defendant of this trial, Edgar Enge, served as a guard in the Semlin *Judenlager* near Belgrade, whose inmates are said to have been summarily killed with a Saurer “gas van.” The defendant was accused of having, on a few occasions, accompanied the van on its way to the mass graves and having secured the unloading of the vans by other inmates. With regards to the features and operation of the gas van itself the court verdict is rather terse. In contrast to the Köln court, which claimed 25 occupants per gassing, this court maintains 50 victims per load (p. 412).

There is little interesting in this verdict for our purposes. The defendant’s defense strategy was once more not to deny the “established facts” claimed by the prosecution, yet to claim that resistance was impossible. The only witnesses testifying during that trial were other German guards. They all had their own versions about what allegedly transpired, pointing with fingers all over the place but never to themselves (pp. 413f.), so that at the end the court surrendered to this irresolvable mess of anecdotal discrepancies and judged “*in dubio pro reo*” regarding one charge. Although sentenced for aiding and abetting in the mass murder of the Serbian Jews, the court abstained from meting out a

prison term for it, primarily because right after the war the defendant had already spent more than three years in Allied custody due to his mere SS membership (p. 419).

I may mention in passing that during a pre-trial interrogation Enge is said to have stated that “it was an open secret that Jews were being gassed with that van” (Manoschek 1998, p. 231). That remark may be innocuous, but it may also indicate that Enge found out about this secret, unknown to him at that time, only after the war, when everybody claimed that the alleged “Nazi genocide against the Jews” was an open secret. This notion is supported by yet another statement made in 1952 by a head of department in Harald Turner’s wartime military administration in Serbia, a certain Dr. Walter U. He is said to have stated that he “found out from ethnic German circles in the spring of 1942 that the Jewish inmates of the camp were being gassed” (Manoschek 1998, p. 231). If this alleged mass murder with special vehicles had been a fact indeed, it seems unlikely that a head of department of the German military administration in Serbia would have found out about that fact only from rumors spread among civilians in Serbia. It does not seem very likely either that Dr. U. made up this story in order to hide any first-hand knowledge he might have had. In that case a flat denial of such knowledge would have been the most likely approach.

#### 3.7.4.8. LG Dortmund, Verdict of 16 Jan. 1969

The defendant during this trial was Herbert Andorfer, at war’s end an *SS-Obersturmführer* who had volunteered for service at the SS headquarters of an *Einsatzgruppe* in Serbia. All through the war Andorfer’s official primary occupation was fighting partisans, initially in Serbia, but later also in Italy (p. 676). Starting in January 1942, however, Andorfer was the head of the Semlin *Judenlager* until it was dissolved in the summer of 1942 (p. 679). In that function he is said to have regularly accompanied the “gas van” on its 15 km long way out of the camp through Belgrade to the burial ground. Since this involved passing the newly established border between wartime Croatia and Serbia, Andorfer’s claimed primary duty was to make sure that the van would not be stopped and searched at that border. The defendant confirmed these claims, although he claimed that he thought the occupants of the van had been dead by the time it left the camp (p. 683). He received a 2½ year prison term for aiding and abetting in mass murder.

Much of the “facts” about the alleged gas van deployed in Serbia as stated by the verdict have been taken from the various documents discussed here in chapter 2. Even the height of the van’s cargo box (1.70 m, p. 680) was obviously taken from the Gaubschat correspondence (memo of 27 April 1942). About the gassing mechanism the verdict states (*ibid.*):

*“The vehicle was equipped with a special device (lever, connecting hoses and pipe) allowing for the poisonous carbon monoxide gases of the running engine to be piped into the cargo box [...]. The device serving this purpose could not be seen from the outside.”*

Here we have yet another story about a lever inside the driver’s cabin (as it was not visible on the outside) and several hoses. This resembles the description as given in the Cologne verdict against Dr. Schäfer for the same crimes allegedly committed in Serbia (see chapter 3.7.2.4), and it may be assumed that it was actually copied from there. No further detail about the van’s equipment is given.

In one regard the present verdict deviates from the 1953 Cologne verdict discussed in chapter 3.7.2.4: it claims that the victim’s luggage was transported in a separate truck along with the gas van to the burial site (p. 681). If that is so, the question arises: why would the Germans have sent the victim’s luggage on a separate truck together with the “gas van” to the burial site? Did they bury the luggage as well? This makes sense only if this convoy was *not* a homicidal one driving to a burial site, but rather one serving to relocate the persons *with their luggage*.<sup>118</sup>

In this context it is interesting to note that Andorfer’s attitude toward the inmates of the Semlin camp was quite the opposite of what one might surmise, as Browning reported (Browning 1983, p. 63):

*“Finally, the new commandant, Herbert Andorfer, noting that the food ordered represented the absolute minimum required rations, threatened that no bills would be authorized until all orders were filled. The Belgrade municipal government warned its Department of Social Welfare that the Germans were ready to prosecute those responsible for unfilled orders for urgently needed supplies. Up to this point, at least, the German commandants were not behaving as if they knew that their prisoners were soon to be murdered.”*

---

<sup>118</sup> Browning claims that the luggage truck eventually turned off (Browning 1983, p. 80).

*“As camp commandant he had worked for more than a month with the camp’s ‘self-administration’ and [had] become personally acquainted with about 50 of the prisoners. By his own account he had even drunk coffee and played cards with some of the prisoners in the camp administration after they had learned not to fear him.” (Ibid., pp. 78f.)*

And after all this, when faced with the alleged order to kill these inmates, he simply complied. Is that credible?

The verdict also has a forensic glitch when it states (p. 681):

*“The corpses’ faces had a reddish-pinkish color throughout, which indicated a poisoning with carbon dioxide.”*

Carbon dioxide poisoning leads to a bluish skin color, a sign of oxygen deprivation. Carbon monoxide would result in a reddish skin discoloration, a sign of oxygen over-saturation, yet a Diesel engine driving with a low engine load across a city wouldn’t produce sufficient amounts of carbon monoxide to cause such a discoloration.

#### 3.7.4.9. LG Kiel, Verdict of 11 Apr. 1969

This trial was held against two defendants: Heinz R.H. Richter as head of *Einsatzkommando 8* within *Einsatzgruppe B* during summer 1942 while deployed in the vicinity of Mogilev, and Hans Karl A. Ha.[?] as the head of this *Einsatzkommando*’s external services. They both were sentenced for their alleged involvement in the mass shootings and gassings in gas vans of Jews. Richter was sentenced to seven years, Ha. to five and a half years.

Interestingly the court used, among many other documents, not only the written statements of numerous witnesses who never appeared during this trial, but also the affidavits of witnesses who had died long before even the investigations for this trial had started (pp. 8f.), a practice which is considered illegal under Anglo-Saxon law.

The unusual feature of this trial is the fact that both defendants had a long track history of having been philo-Semites before and at the beginning of the war. Richter had a relationship with a Jewish woman and helped her escape, just as he helped numerous other Jews in various ways (pp. 11, 14). Furthermore, as a prosecutor in France during the German occupation Richter also showed no reluctance in prosecuting superiors and other high-ranking Germans who had committed illegal acts against Jews (pp. 13f.). The second defendant was no less eager to



help Jews avoid being arrested by the Gestapo or to ease their lot after imprisonment (pp. 19f.)

This raises the question how two philo-Semites could so easily be converted into mass-murdering automatons once deployed behind the eastern German frontline in Russia.

According to this verdict, *Einsatzkommando* 8 is said to have received a “gas van” in May or June 1942 and is said to have used it until September of that year (pp. 25, 33f.).<sup>119</sup> The verdict’s description of this van is terse (p. 33):

*“This vehicle was a box-like vehicle similar to a moving truck, lined with sheet metal on the inside. A hose connected to the exhaust pipe of the van was used in order to pipe the engine exhaust gases into the hermetically sealed van [...].*

*When the gas van was filled, the winged doors were closed, and the driver Schl. drove the van with an accompanying person and under guard to a tank ditch. Meanwhile in the interior the victims stood cram-packed next to each other on the fully used loading surface [...]. After a drive of 10 or 15 minutes the gas van reached the tank ditch. Here the actual killing operation commenced. The hose was connected, the engine brought to a certain speed, and thus the victims were killed within 10 to 15 minutes by means of the exhaust gases piped into the van.”*

It is not clear what the sources for this description are, although it may be assumed that the Becker and Just documents listed in the verdicts (p. 7) were of major importance, all the more so since the verdict itself states (p. 34):

*“About the gas van deployments conspicuously few witnesses made more detailed statements. Even those witnesses who, despite a general unwillingness to make statements, have stated relatively much about the shooting actions, became instantly reluctant when confronted with questions about the gas van actions.”*

While the court considered the horrific nature of the gas van deployments as the main reason, I posit that lack of knowledge about any technical or operational detail made the witnesses reluctant. Shootings, after all, happen in every war, so no fantasy or inventions are necessary to report about them, whether real or invented. Yet those elusive gas vans are obviously a different matter altogether. In addition, what scant

---

<sup>119</sup> Note that this timeline contradicts the data in the wartime document analyzed in chapter 2.2.8.

“knowledge” the witnesses claimed to have had about those vehicles might actually stem from prior interrogations and trials, as was stated in a trial held three years earlier against another German defendant involved in the same activities of *Einsatzkommando 8* (see chapter 3.7.4.4.).

About the defendants’ attitude during the trial the verdict states (p. 41):

*“While the defendant Ha. admitted this – his – participation at the extermination actions against Jews ordered from Mogilev, claiming to have received orders for this from the defendant Ric.[chter], the latter denied to have been involved in any way in the extermination measures of Einsatzkommando 8 against Jews.”*

Richter’s categorical denial of involvement did not include his contesting that the extermination took place, though. He merely claimed to have steadfastly refused to follow orders about it as received from higher up after he had been forced once to attend a gas van execution (*ibid.*). As to mass shootings, he claimed to have attended only one of them where merely partisans had been shot (p. 42). He even claimed to have known about the actions against Jews only because the other defendant had told him on occasion that a “Jew action” would take place the next day (p. 44).

It is worthwhile reminding the reader that Richter had claimed during the above mentioned earlier trial to have found out only during post-war interrogations that there was a gas van in his detachment (see chapter 3.7.4.4.).

It goes without saying that, in view of the preordained “self-evident” nature of such mass executions, the numerous witness statements to the contrary, the *Einsatzgruppen* reports sent to Berlin, Richter’s leadership position within *Einsatzkommando 8*, and internal inconsistencies in Richter’s various trial and pre-trial statements, the court could not believe him. In fact, a large section of the verdict is dedicated to refuting Ric’s claims (pp. 43-62).

Within this lengthy refutation one can also find a brief, yet incomplete list of reasons for the potential inaccuracy of witness testimony (p. 57). It is incomplete because it does not include the possibility that many witnesses subjected to massive prosecutorial as well as societal pressure are perfectly capable of inventing very detailed, superficially plausible stories in order to yield to that pressure, as I have described in chapter 3.4.

A possible point in case here is the witness referred to by the verdict merely as “Schl.” He was the main witness for the “gas van” mass murders, as he testified extendedly about his alleged activities as the driver of the gas van deployed at *Einsatzkommando 8* (pp. 34, 39 56-58). Since Schl.’s detailed confessions amounted to a massive self-incrimination leading to his own indictment and trial in front of the same court a little while later (see chapter 3.7.4.11.), the court interpreted his confession as credible (p. 34). Never mind the fact that, according to the witness Graalfs, during another trial Schl. had admitted while testifying in court that he did not know whether he was telling “the truth or poetry” and that at that point he tried to distance himself from the matter (p. 58).

It was convenient for the court that almost all witnesses testifying during this trial had themselves been members of the German armed forces in one way or other, which somehow in the eyes of the German judiciary and the public at large renders their statements credible only if they are self-incriminating. Hence the judges could at will declare this or that statement as plausible or implausible, depending on the need to come to the expected, politically correct verdict.

The case of the witness “Pri.” undergirds this notion. Pri. had claimed that at one point all the inmates of the Mogilev prison were shot because some of them had been diagnosed with typhus. Apparently this claim had not been bandied about sufficiently yet, so none of the defendants or other witnesses could “remember” such an event, hence the court acquitted the defendants in this regard (p. 74). Yet instead of concluding that Pri. had probably either made up the event or was no longer capable of distinguishing between fact and rumor and thus had to be rejected as an unreliable witness, the court accepted Pri.’s second wild story about the summary execution of the inmates of an insane asylum with engine exhaust gases, just because the submissive defendant Ha. had admitted his involvement in this event (pp. 74f.).

#### 3.7.4.10. LG Darmstadt, Verdict of 18 Apr. 1969 & 23 Dec. 1971

This trial was held against three defendants, two of whom were indicted exclusively for their participation in mass shootings (Theodor L. Chri[?].[?], Karl Ernst R. Kref[?].), which is of no relevance to the present investigation. These two defendants were acquitted in 1969, whereas the third, Wilhelm Findeisen, was retried and sentenced to 37 months imprisonment for his involvement in mass gassings as the driver

of a “gas van” while serving at the headquarters of *Einsatzgruppe C* in Kiev and at *Sonderkommando 4a* in Kharkov.

The gas van which the defendant is said to have driven from Berlin to Kiev in November 1941 is described in the verdict as follows (1969, pp. 93f.; 1971, p. 469f.):

*“This vehicle was a larger truck of a foreign make painted grey which looked like a moving truck. It was equipped with an airtight cargo box which was separated from the driver’s cabin and could accommodate some 40 to 45 standing persons. The interior was lined with sheet metal and had removable wooden grates on the floor, beneath which were pipes. A metal hose was connected to the opening of the pipes at the cargo box, which could be screwed onto and thus connected with an especially designed exhaust pipe floor. The rear of the cargo box had a winged door, which could be sealed almost [sic] airtight from the outside. The engine exhaust gases reached the interior through the hose and caused the death of those locked up inside.”*

In this case the executions are said to have been conducted while the truck was in transit to the burial sites, lasting some 15 to 30 minutes (1969, pp. 94f.; 1971, pp. 470f.).

Since the defendant operated the truck for roughly half a year all by himself, and also because the defendant – according to the court – had emphasized that he had been instructed on how to connect the hose to the exhaust pipe (1969, p. 94; 1971, pp. 470, 475), his description of a hose which could be screwed to an especially designed exhaust pipe and about several “pipes” on the inside underneath the “wooden grates” must be taken seriously. But his description is still nonsensical, technically speaking, and it is contradicted by many other witnesses, who describe other, often similarly or even more nonsensical ways of connecting the hose to the exhaust pipe.

It is also strange that the court – and thus probably also the defendant – did not specify the actual make of the truck. Since the defendant used it for half a year during many quite memorable events – if they took place – it is hard to believe that he could not remember the make of the vehicle. Was it one of the legendary, yet elusive Diamond trucks?

One rather peculiar statement in the verdict should not be withheld from the reader. It concerns the severe cold during the Russian winter (1969, p. 95; 1971, p. 471):

*“In order to keep the gas van operable, it was protected from the severe cold during many days and nights by lighting a fire underneath the vehicle in order to protect it from freezing.”*

If that is true, I wouldn't be surprised if that was the actual reason why the gas vans were frequently defective, as the court stated in the sentences before. Any rubber or wooden parts wouldn't have liked a fire in their vicinity at all, not to mention lubricants, fuel, hydraulic liquids etc.

### 3.7.4.11. LG Kiel, Verdict of 28 Nov. 1969

This trial was held against Heinz Joachim Schl.[?], a self-incriminating defendant who had previously played an important role during other trials by delivering the courts “first-hand” knowledge about the gas van deployment (see *e.g.* chapter 3.7.4.9.). Here he faced charges regarding his claimed activities as a gas van driver for *Sonderkommando* 8 in and around Mogilev from June to August 1942 (pp. 287, 293). But because they considered the defendant's firm belief credible that refusing orders to partake in the mass gassings would have endangered his own life (the so-called “putative emergency situation,” pp. 301-307), he was acquitted.

The gas vans are initially described only in passing as vehicles with cargo boxes, into which the engine exhaust gases were piped via a hose, resulting in the victims' death within 10 to 15 minutes. This statement is followed by quotes from the Becker and Just documents (p. 284). Afterwards we find a somewhat more detailed description, the source of which is unclear, but probably stems from the defendant himself (*ibid.*):

*“The vehicle had a truck frame upon which a cargo box of some 7 to 8 m was installed. The box could be opened at the rear with doors. The vehicle had a grey exterior painting. The interior of the box was lined with sheet metal. A wooden grate was on its floor, beneath which two longitudinal pipes and a cross pipe ran, which were equipped with small holes through which the engine exhaust gases were led into to box's interior. The exhaust pipe tapered off conically; the cone sported a throat with a cap nut, to which a hose was connected, whose other end was attached to the vehicle's cargo box in order to perform the gassings. Some 50 to 55 persons could be accommodated in the vehicle's cargo box with much effort; already with 50 persons the cargo box was overcrowded.”*

Regarding the uselessness of those criss-crossing pipes underneath the wooden grate and the unlikely use of a thread in the exhaust pipe to affix a hose I have made ample remarks before, so I will spare the reader a repetition. In addition, is there a need to point out that a pipe tapering off conically cannot have a functioning thread? Also, a cargo box of 7 m length and 2 m minimum width has a surface of at least 14 m<sup>2</sup>. Allowing for a mere five persons per square meter would already result in 70 people for the entire van. Cramming ten persons on a square meter would permit 140 people to fit into the cargo box. Were the judges unable to perform such simple basic multiplications?

New about the gassing procedure claimed by the defendant is that all gassings are said to have been conducted at night “in order to avoid unsettling the local populace” (p. 285). There is no supportive evidence for such a claim, though.

Although it is claimed by various verdicts that the perpetrators devised various schemes to lull the victims into believing that the tour they were about to embark on served to resettle them to another town or camp, or else to drive them to some delousing procedure, this verdict claims that from a certain point in time onward all victims had to undress themselves prior to entering the van (p. 285), which would have nixed any attempt at making them believe the ruse they had been told by their malefactors. To top it off, the verdict states that the victims even had, “among other things, their golden dental prosthesis broken out” before embarking on their supposed final journey (p. 286). However, dentures do not need to be broken out of one’s teeth, nor are they ever made of gold, as gold is too soft a metal for dentures; but crowns and fillings were and are frequently made of an alloy containing gold, and they had to be broken out of one’s teeth. But breaking crowns or fillings out of the teeth of living victims without consent and anesthesia is no small feat, to say the least. We can glean from this that the judges seem to have believed just about any nonsense the defendant and/or the witnesses told them.

The verdict describes the defendant as a “truth-loving, sensible person, yet mentally not very flexible” (p. 292), or in plain English: he was a simpleton whose memory could easily be fooled. That may be the root cause of all the nonsense this defendant told during his various testimonies and interrogations, and it may also be the reason why he, during a different trial, had exclaimed that he is no longer certain whether what he is telling is “the truth or poetry” (see p. 226). But one truth is certain:

the judges following each and every single one of his tales have exhibited a mind that is just as inflexible.

### 3.7.5. From 1970 to 1974 (6 trials)

#### 3.7.5.1. LG Frankfurt/M., Verdict of 19 Mar. 1971

This trial was held against the defendant Karl Stro.[?] for his alleged involvement in mass shootings and gassings using a gas van while serving in *Einsatzkommando* 8 in Mogilev and other location in the occupied Soviet Union. As in the case against Heinz Joachim Schl. (see previous chapter), this defendant was also acquitted due to a “putative emergency situation” (pp. 144-146).

The verdict’s description of the van and the gassing procedure is rather terse (pp. 138f.) and reads like a shortened summary of descriptions given by other German post-war verdicts. According to this, the van could hold 50 to 70 victims, had a double door at the back of its cargo box, was lined with sheet metal on the inside, was equipped with several wooden floor grates, beneath which were pipes sporting small holes to distribute the exhaust gases, which were piped in via a hose. The van would kill the victims while stationary within 8 to 10 minutes with the engine revved up. One specialty of the van described by this court is that it had “observation slits” in the back doors. If referring to observation openings at all, other verdicts state that the gassing could be observed from a window leading from the driver’s cabin to the cargo box. The procedure itself was, so the verdict, even “more cruel” and “more terrible” than the executions by shooting which they were meant to replace (pp. 139, 143).

In addition to this, the verdict claims that the defendant was also indirectly involved as a guard in killing mentally sick people locked up in a room, into which the exhaust gasses from a truck were piped via a hose and through a hole freshly broken through a wall (p. 140; cf. chapter 3.7.4.9.). This reads like a repetition of the story told by Albert Widmann (see p. 218), which is not to say that it is necessarily untrue. Since euthanasia killings were performed in Germany proper, it is possible that similar deeds were committed in various German occupied territories as well.

### 3.7.5.2. LG München I, Verdict of 22 Mar. 1972

This trial had three defendants, given in the verdict only with the first three letters of their last names: Karl Fin.[?], Siegfried Schu.[hardt], and Theodor Lip.[?] They received 4½, 5 and 3 years, respectively, for their alleged involvement in the mass murder by shooting and gassing in a gas van in numerous locations of the occupied Soviet Union as members of *Einsatzkommando* 10b (pp. 63-66).

This verdict's description of the gas van allegedly used and the gassing procedure is very short as well (p. 75):

*“This gas van was a truck with an enclosed cargo box resembling a moving truck, whose rear doors could not be opened from the inside. Exhaust gases were piped into the interior during transit, and thus the human beings were killed.”*

On the same page we also find this quite astounding statement:

*“As a result of complaints from members of the command, the defendant Schu. later refused to use the gas vans again, on the grounds that it was impossible to persuade the people [the members of the command] to carry out such a task.”*

Such a statement does not only undermine any defendants' attempt to claim that refusing to cooperate in these killings was threatened with punishment, but it also undermines the claim of orthodox historians that the vans were introduced to alleviate the stress of German soldiers asked to shoot people.

### 3.7.5.3. LG München I, Verdict of 14 July 1972

This trial was against three defendants (Kurt Tri.[?], Friedrich Sev.[?], Heinrich Gö.[?]), each of whom received a four year prison term for adding and abetting in mass murder ostensibly committed while a member of *Einsatzkommando* 10a of *Einsatzgruppe* D in southern Ukraine. For the present study only the case of Dr. med. Heinrich Gö. is relevant, as he was accused of ordering the asphyxiation of 214 sick children residing at a children hospital in Eysk (Jeissk in the verdict) in October 1942 by means of a gas van.

The verdict's description of the gas van is again rather short and reads as follows (p. 408):

*“The ‘gas van’ or – as the Russians called it – the ‘soul killer’ was a large truck with a cargo box. It had false windows painted on the outside walls, and a large double door at the back with which the cargo compartment could be closed. The cargo box was lined with*



*white sheet metal on the inside, and the floor was covered with a wooden grate. A hose permitted the exhaust fumes to be directed into the interior from below.”*

Although the verdict claims that this is the summary of a number of “basically” (whatever that means) congruent witness statements (p. 419), the alleged Russian nick name for this vehicle – “soul killer” – as well as the false windows were first claimed by the Soviet show trial in Krasnodar (*The People’s Verdict* 1944, pp. 16f.), but are otherwise conspicuously absent in witness statements and court verdicts.<sup>120</sup> This gives us a clue where the entire theme of this trial comes from: it is basically a repetition of the Krasnodar show trial, with new defendants and a different children hospital (cf. *The People’s Verdict* 1944, pp. 27-31, 35), but otherwise all the old claims and methods, including the uncritical acceptance of testimonies made by Soviet “witnesses” – or as the verdict puts it naïvely: “no manipulation of the [Soviet] witnesses has been noticeable” – plus a forensic expert report about 214 exhumed children allegedly killed with carbon monoxide produced by the Soviets back in 1943 (pp. 412, 419; cf. *The People’s Verdict* 1944, pp. 31f.; see chapter 3.2. in this present study).

That neither the defendant nor the witnesses knew why these 214 had to be killed is of no relevance. The court knew it: they had to make room for injured German soldiers (p. 421).

The defendant, by the way, denied having had any knowledge, let alone having been involved, in the murder of these children. He also claimed to have seen a gas van only twice and from a distance (p. 422). How he could have known “from a distance” that this was “the” gas van is a mystery, though. Of course the judges did not believe him.

#### 3.7.5.4. LG München I, Verdict of 29 Mar. 1974

At the end of this trial the three defendants – Johannes P. Schlu.[?], Heinrich A. Win.[?], Rudi F. Esc.[?] – were sentenced to 4½, 3, and 5 years imprisonment for their various contributions to the claimed mass murder of Jews allegedly committed by *Einsatzgruppe D* in southern Ukraine. Only the – confessing – defendants Schlu. and Esc. were accused of having been involved in the operation of a “gas van” by *Einsatzgruppe 11* in the Ukrainian town Cherkessk.

<sup>120</sup> The Polish peasant Andrzej Miszczak who lived close to the Chelmno camp and had heard “rumors” about gas vans (Bednarz 1946c, p. 47) called these vehicles “hell autos” (*ibid.*, pp. 23, 47f., 52).

The verdict's brief description of the "gas van" reads like the one contained in the verdict handed down by the same court some 20 months earlier (LG München I, 14 July 1972; see previous chapter), including the alleged vehicle's nick name and the painted-on, false windows (p. 601):

*"This vehicle, which was called 'soul killer' by the Russians, was a large truck with a cargo box. It had false windows painted on the outside walls, and a double door at the back with which the cargo box could be closed. A hose permitted the exhaust fumes to be directed into the interior from below."*

It may thus be assumed that the judges copied it from there. The gassing itself is said to have occurred while the vehicle was stationary, during which exhaust gas was piped into the interior for "at least five minutes" (*ibid.*), which is an execution time on the short side.

Nothing else can be gained from this verdict for our study.

#### 3.7.5.5. LG Kiel, Verdict of 14 June 1974

This extraordinary case involves the defendant Heinz G. Rie.[?], who was the head of unit 570 of the German secret military police (*Geheime Feldpolizei*) during the war. He had been indicted for killing Soviet partisans by means of a make-shift "gas van" in Mogilev in June 1944, shortly before the town was retaken by the Red Army. Since the execution of partisans was covered by international law, the defendant was acquitted.

The "gas van" is described as follows (p. 662):

*"The defendant knew that the security service (Sicherheitsdienst) had deployed to a considerable degree and over a longer period of time a gas van for the extermination of Jews. Due to a conversation [...] the idea occurred to him to also set up and deploy a gas van for the execution of partisans sentenced to death. At least two months before the retreat of his group from Mogilev end of June 1944, the defendant arranged for a Russian truck of the make Ford with a gasoline engine to be refitted as a gas van. [...] Since the tarpaulin covering the cargo area had been destroyed in Roslavl and as no replacement could be obtained, the defendant arranged for it [the vehicle] to be equipped with a sturdy compartment made of boards while still in Roslavl. In Mogilev the vehicle was now sealed with metal plates and equipped with a device which permitted to pipe the exhaust gases into the interior of the cargo box. After operating a*

*lever in the driver's cabin, the exhaust gases were blown through a pipe into the cargo box."*

The gassing procedure during transit is said to have lasted 15 to 20 minutes (p. 663).

The Soviet Union did indeed produce Ford trucks equipped with gasoline engines prior and during the war, made under license from the U.S. Ford company. It is doubtful, though, whether the Germans could have located the required amount of sheet metal for such a project, considering that, in the summer of 1944, supplies at the eastern front were extremely scarce and that the German lines were overrun by Soviet troops only a few weeks later. Regarding the described gassing mechanism, however, I think it can be excluded with certainty that a complex lever mechanism operable from within the driver's cabin would have been designed and constructed for such a makeshift gas van merely designed to execute a few partisans (the court assumed as certain only the execution of four (4!) partisans in this way).

The source of this story is not known. The verdict merely states that the defendant did not contradict this description, which probably means that he didn't say anything about it at all. Six other witnesses mentioned in the verdict merely claimed to have "heard" about this makeshift gas van from others. Hence the entire story sounds more like a rumor than an established fact.

In deviation from other court verdicts dealing with gas van murders, this court came to the conclusion that the execution with carbon monoxide was not cruel (pp. 664f.). The expert witness testifying about the way death occurs during CO poisonings even referred to poison gas executions in U.S. gas chambers with hydrogen cyanide, which he considered to be relatively humane as well (p. 665).

### 3.7.5.6. LG München I, Verdict of 15 Nov. 1974

Of the two defendants on trial, only the case of Walter Keh.[?] is linked to the deployment of an alleged "gas van." As an interpreter of *Einsatzkommando* 12a within *Einsatzgruppe* D, which operated in southern Ukraine, he is said to have been involved in the gassing of Jews while stationed in Simferopol on the Crimean Peninsula.

The bogus nature of this entire case becomes clear when considering the British trial against German General Field Marshal Erich von Manstein in 1949. Manstein, who during the war was the commander in chief of Germany's 11th Army operating on the Crimean Peninsula,

among other places, had been indicted by the British for assisting in the *Einsatzgruppe D*'s claimed mass murder of the local Jewish populace. Yet Manstein's defense team managed to prove that the local Jewish community was never threatened with destruction, let alone that it was destroyed (Paget 1951, pp. 170f.).

The verdict here under scrutiny has the leanest description of those alleged "gas vans" ever encountered in any verdict. All one can read there is (p. 287):

*"During these operations the victims were loaded into the gas vans – trucks with hermetically sealed cargo boxes – and killed by engine exhaust fumes. [...] After loading the winged rear doors were closed. The van stood with its engine running for five to ten minutes, during which time the exhaust fumes were directed into the interior of the cargo box by a special device. [...] The victims finally died after a few minutes, caused by a paralyzed brain due to lack of oxygen. [...]"*

*When nothing more could be heard from the interior, the van drove to the anti-tank ditch that had been dug around Simferopol."*

This finding follows the common, yet technically impossible pattern of hermetically sealed cargo boxes. The alleged gassing is here claimed to have happened while the van was stationary. The introduction of the exhaust gases by means of "a special device" is awkwardly imprecise. The killing time reported is on the low side.

As to the defendant's attitude the verdict elaborates (p. 294):

*"[...] the defendant denied strongly having participated in any gas van operations. He stated that he has never seen a gas van in his life and that he had not even heard of the existence of such vehicles at that time; [...]"*

Evidence to the contrary originated almost exclusively from testimonies and affidavits by Russian citizens (p. 294), the same kind of witnesses that had appeared during the Krasnodar show trial. The defendant's suspicion of a Soviet orchestration of these testimonies was brushed aside by the court (pp. 295). The 1943 Krasnodar trial and its show trial nature as the origin of the claims leveled against the defendant are not mentioned in the verdict.

The defendant was sentenced to four years imprisonment.<sup>121</sup>

---

<sup>121</sup> The other defendant, "Max Dreh.," was sentenced to five years imprisonment.

### 3.7.6. From 1975 to now (1 trial)

#### 3.7.6.1. LG München I, Verdict of 19 Dec. 1980

This trial was conducted against the defendant Dr. Kurt Christmann, head of *Einsatzkommando* 10a within *Einsatzgruppe* D. He has been accused of mass gassing of Soviet partisans, among them children, while stationed in Krasnodar. Christmann was also the (absent) chief villain during the Soviet Krasnodar show trial of 1943 (*People's Verdict*, 1944, pp. 14, 17f., 21). With this, the stage was set for a repetition of this show trial, for which numerous Soviet witnesses testified who had been “screened” by the Soviet secret service KGB before their appearance in court (p. 271). Köhler (2003, p. 114) has highlighted the manipulative character of these KGB screenings, which became a public notoriety during the Frankfurt Auschwitz trial.

Although the defendant claimed that his trial was yet another communist setup (p. 270), the court tried to dispel this claim by arguing that the various testimonies of Soviet as well as German witnesses made “independently” from each other over a period of several decades could not possibly have been orchestrated by the Soviet authorities (pp. 271-274). Even though that would be true regarding details of such testimonies – which, however, could not possibly be expected to be congruent anymore after almost four decades had passed – the conspicuous feature of most of those testimonies is actually their general *lack* of details. For the most part the witnesses merely repeated war time propaganda claims and postwar mass media clichés and pinned them on whichever defendant they were let loose against.

The verdict describes the “gas van” as follows (p. 251):

*“As an external identification sign a card-game heart was painted on the truck according to the designation of Einsatzgruppe ‘10a.’ It was a 6 ton truck with a gasoline engine and a closed cargo box with a loading surface of at least 2 × 4 m. It was lined with sheet metal on the inside, had no seats, no separating walls and was locked hermetically from the outside air with a winged door at the back. As camouflage both toward the local populace as well as toward the victims who had to enter the truck, false windows and closed curtains were painted on the left- and right-hand outer side of the cargo box, which, however, was pitch-black dark on the inside with the doors closed. By means of a lever the driver could pipe the*

*engine exhaust gases through a hose into the interior of the vehicle in order to kill the locked-up victims.*

*[...] the number of victims in each case amounted to at least 30 persons.*

*[...] After that the driver closed the winged door, sat down in the driver's cabin, started the engine, which he left running while stationary, and directed the exhaust gases into the interior of the van. [...]*

*The gas van remained in the courtyard of the commando building with its engine running until no sound could be heard from inside. Only then did the van leave the courtyard."*

I was not able to verify whether a red card-game heart was indeed the identification sign of *Einsatzkommando* 10a. Since this was a rather small unit of merely some 100 persons (p. 250), I doubt they had any dedicated sign to begin with. Here, too, the 1943 Soviet show trial theme of painted windows perseveres, this time even embellished with curtains, and the lever in the driver's cabin to turn on the gas is just as unrealistic. These technical data are said to have been given by the witness Tho. and were allegedly confirmed by various Soviet witnesses (p. 279), which means that here we have evidence for the convergence of nonsense.

The defendant has to share a part of the blame for the success of the Soviet campaign to frame him, because he merely tried to convince the court that he had nothing to do with those gas van deployments and did not care about them either, hence had no knowledge about them. He even claimed that he had heard only from one of his colleagues, Dr. med. Heinrich Gö., about the mechanics of the gassings (pp. 261f.). It goes without saying that such a defense strategy for the head of this commando was doomed to fail right from the start. The judges even knotted a noose from his statement about his lack of knowledge: because he didn't care about the gas vans, he was indifferent to the mass murder and hence a most callous mass murderer (p. 276).

Dr. Gö., by the way, denied ever having spoken to the defendant, and during his own earlier trial he had stated to have had no knowledge about those vans himself (see chapter 3.7.5.3.).

During this trial the common feature of testimonies given by German witnesses was once more that they had "knowledge" about the gas van only from hearsay, if at all, or because they happened to have seen such a van standing around somewhere at some point, though not while

in operation (pp. 277-280). This raises once more the question how the witnesses could have known at that time that the van or truck they saw standing around was indeed a “gas van” in terms of a vehicle for mass murder with poison gas? The court does not seem to have been interested in finding out, since the German witnesses were generally suspected of not being truthful, hence were rather irrelevant witnesses anyway. Or as the defendant expressed it succinctly when the prosecutor pointed out to him that he should behave himself because he is a defendant (p. 276):

*“But only because we have lost the war!”*

The court used this statement also against the defendant as proof that he only regrets to have lost the war, but not to have killed innocent people. Yet that statement by the defendant cuts the other way as well, because due to Germany’s total defeat and the total domination of all kinds of Allied atrocity propaganda stories ever since, an effective defense against bogus claims has become almost impossible for a German defendant involved in controversial events during World War II. It has become self-evident on a global scale that Germans were the chief villains of World War II. Every German defendant, the incarnation of evil as such in the eyes of the public at large, the prosecution and usually also of the judges, was confronted with that incontrovertible, insurmountable dogma.

The defiant Christmann was ultimately sentenced to ten years imprisonment.

### 3.8. Gas Vans during Communist East German Trials

#### 3.8.1. General Remarks

Except for the last verdict studied here (see the list below), each one was handed down against merely one defendant for “war crimes and crimes against humanity according to article 6, letters b and c, of the Statute of the International Military Tribunal in Nuremberg of August 8, 1945.” This means that, by the very laws applied, all these trials were legal extensions of the Nuremberg Trials. This shows even in the fact that at times the verdicts of the IMT and of respective NMTs as well as evidence presented during those trials were quoted as evidence (see *e.g.* case 1024, pp. 640f.; case 1044, p. 283).

Hence, in sharp contrast to the West German trials which applied penal law in existence at the time when the crimes are said to have been perpetrated, the East German communist judiciary applied laws which had been enacted only after the war, which is a crass violation of basic legal standards of nations under the rule of law.

In addition to this, the verdicts themselves are filled with communist political and historical rhetoric which makes it at times difficult to read them. Here are a few selected quotes (emphasis added):

*“On 22 June 1941 the German Fascists continued their war of aggression, which they had begun in 1939, with their devious, insidious and treacherous assault against the USSR with the aim to destroy the Soviet Union as the first socialist state.”* (Case 1018, p. 487)

*“With the creation of the fascist dictatorship the German imperialists immediately initiated measures to implement their plans for world domination which they had held for years.”* (Case 1024, p. 637)

*“When the fascist tyranny was erected in Germany in 1933, the darkest epoch of human history began. The Hitler state as the power organ of the German monopoly capitalists [...]”* (case 1082, p. 387)

*“After the assault of the fascist troops against Austria...”* (Case 1163, p. 471)

*“By prosecuting war crimes and crimes against humanity [...] the determination of the workers’ and peasants’ state is documented to do anything in order that a war will never again originate from German soil.*

*By this the socialist German Democratic Republic distinguishes itself decisively from the ruling order of the Federal Republic of Germany, whose aggressive character has not changed. Although they wish to make the world believe that there is no continuity between the Federal Republic of Germany and fascist Germany [...] the domestic and international politics prove again their reactionary character. These neofascists and incorrigible militarists in West*

**Table 5:** East German Court Cases Addressing Gas Vans

VOL.*	# (COURT, DATE OF VERDICT IN YYMMDD)**
I	1018 (LG Berlin 780814), 1024 (LG Karl-Marx-Stadt 760611)
II	1044 (LG Karl-Marx-Stadt 711202)
III	1082 (LG Neubrandenburg 610222)
IV	1163 (LG Greifswald 520703)

\* Volume of Rüter *et al.* 2002ff.; \*\* case no. acc. to Rüter



*Germany have learned nothing from history. They propagate, 30 years after the assault on the Soviet Union that 'this German offensive of June 22, 1941, was a classic preventive war.'*

*With approval and support of ruling circles in West Germany, the criminal SS units with their commanders march about, for instance, they 'cultivate their tradition' and are recommended as role models to the soldiers of the Bundeswehr."* (Case 1044., pp. 281f.)

This lengthy introduction to the verdict, of which only a part is quoted here, makes the reader think that it was not the defendant who stood trial in that instance, but rather West Germany, which shows that those communist trials always also had an important political role in morally undermining and thus delegitimizing West Germany. As a whole, the East German verdicts are filled with such communist rhetoric and are thus very similar in tone to those of the Stalinist show trials in Krasnodar and Kharkov in 1943. This impression is reinforced by the courts' occasional use of documentary evidence produced for these trials (see, e.g., case 1018, p. 501) as well as by making ample use of the testimonies of Soviet witnesses of yore.

The verdicts also made dogmatic assertions about history and morals, which they then used as justification to ignore well-established legal principles and international law as valid during World War II, like the illegal nature of partisan warfare and the legality of executing partisans. For the East German court, which were basically lackeys of the Soviet Union, the Russian and Polish partisan fighters were patriots, whereas Germans fighting partisans were terrorists and murderers (see, e.g., case 1018, p. 517). Hence all the defendants in these cases were sentenced for each and every civilian they had killed, whether they had engaged in partisan warfare or not. As a consequence, all defendants either received a life term (cases 1018, 1044, 1163) or were even sentenced to death (cases 1024 & 1082).

When it comes to the actual or alleged crimes committed, the verdicts often read like a dizzying staccato of frequently rather brief indictments. In all five cases studied here, all five defendants gave full confessions, as is traditional custom in communist show trials (1018: p. 502; 1024: p. 649; 1044: p. 294; 1082: p. 394; case 1163: p. 474).

Note also that the first three cases follow in the footsteps of West German cases dealing with the same alleged crimes but trying other defendants. Hence many of these East German trials look to me like

communist copy-cat trials of cases previously “established” as fact by West German courts.

Having said all this, I will now briefly summarize and analyze passages of these verdicts strictly pertinent to our topic. (In contrast to the West German trials, the East German trial cases were numbered anti-chronistically by Rüter *et al.*, so here we start with the latest and proceed to the earliest.)

### 3.8.2. LG Berlin, Verdict of 14 Aug. 1978

This case involves Herbert H. Paland, a former member of the German secret military police unit 570, who is said to have also been involved in the killing of Soviet partisans by means of a “gas van” in Mogilev in June 1944 (see the parallel West German case held four years earlier as described in chapter 3.7.5.5.).

The gas van is described as follows (p. 500):

*“On orders by MP commissar Rie. a truck was converted into a gas van. The closed cargo box was lined with sheet metal on the outside [sic] and thus airtight. It had a double door at the rear end. By means of a special construction exhaust gases of the engine could be piped into the interior of the cargo box. The gases entered from an opening near the driver’s cabin.”*

According to this verdict, not four but five persons were gassed in a truck, which also sported benches along the side wall for the victims to sit on. The gassing took place during a 2 to 3 km transit through Mogilev, *i.e.* within some 5 minutes (p. 500).

The “new” features here are: an outside lining, a gas inlet near the driver’s cabin (probably so the driver can operate it from his cabin?), and benches for the victims to sit on. The theme of an outside lining may stem from a Jewish propaganda booklet published in the U.S. in 1943 entitled “*The Black Book of Polish Jewry*,” which describes the gas vans in that way, although expressly without any seats (and with a gas apparatus inside the driver’s cabin; Apenszlak 1943, pp. 115-118). This story was in turn based on the so-called “Szlamek Report,” a diary allegedly written by one of the Jews working the Chelmno camp. This unknown “Szlamek” is said to have worked there for only two weeks in January 1942 before he managed to escape. His testimony has also been reproduced by Sakowska (1993, see pp. 162f., 166 for the relevant passages). Carlo Mattogno has thoroughly scrutinized the Szlamek Report, to which I refer the reader (2011a, chapters 6 & 16).

### 3.8.3. LG Karl-Marx-Stadt, Verdict of 11 June 1976

During this trial Johannes E. Kinder faced charges for alleged crimes committed while a member of *Sonderkommando 10a*. The claimed “gas van” murders are said to have involved 214 mentally sick children residing at a children hospital in Eysk (Jeisk in the verdict) in October 1942. It is a parallel case to the West German case described in chapter 3.7.5.3., which had been held four years earlier, to which I refer the reader.

Regarding the gas van the verdict states tersely, and regarding the alleged camouflage in keeping with the above West German verdict (p. 648):

*“This vehicle specifically dedicated for the killing of women and children had a closed cargo box, lined with aluminum sheet metal and camouflaged on the outside as a trailer home.”*

About the 214 child corpses allegedly exhumed by a Soviet commission after the re-occupation of this territory by the Red Army a year or so after the claimed crime, the verdict writes that “some [of the child corpses] still held their crutches in their hands” (p. 648). Yeah, sure.

And here is how the communist court dealt effectively with the defendant’s failing memory about the claimed mass murders (p. 649):

*“That many of the terrible scenes of the mass murder evade the defendant’s memory merely proves that the persecution and killing of Soviet individuals was part of his ongoing ‘work’ and was nothing extraordinary.”*

This way the lack of evidence conveniently turns into supportive evidence.

### 3.8.4. LG Karl-Marx-Stadt, Verdict of 2 Dec. 1971

Georg Frentzel was the defendant during this trial, indicted for his activities while a member of *Einsatzkommando 8*; in this regard it is as a parallel case to three West-German trials held five and two years earlier as described in chapters 3.7.4.4., 3.7.4.9 & 3.7.4.11.

This case does not involve “gas vans” as such but reiterates the theme of gassing mentally sick persons form an insane asylum as mentioned in a West German case tried two years earlier (see chapter 3.7.4.9). This theme follows the pattern of accusations made during the trial against Albert Widmann (chapter 3.7.4.6) and other cases (see chapters 3.7.4.3 & 3.7.4.9.). Like in the Widmann case, here too the

window of a room was allegedly walled-up and two metal pipes were added to a wall in order to allow exhaust gases to be piped into that room. In this case, however, two cars are said to have been used to produce the gas. The process is said to have lasted some 20 to 30 minutes “per batch,” with a total of 600 murdered persons (p. 292).

Just like the Widmann case with the alleged attempt to dynamite the victims prior to resorting to gas, this case too claims such an insane approach (p. 293):

“[...] 200 patients of the insane asylum in Mogilev were killed. [...] The victims [...] were shot in tank ditches, and hand grenades were thrown at them.”

The verdict finally has an interesting statement regarding the gassing with stationary gasoline engine as mentioned by me on p. 27 which I have not found anywhere else (p. 292):

*“The defendant’s car was connected to the gas chamber several times. The vehicles had to be changed constantly in order to prevent the engines from overheating.”*

### 3.8.5. LG Neubrandenburg, Verdict of 22 Feb. 1961

Kurt G. Goercke was the defendant during this trial, facing charges of mass murder in numerous cases allegedly committed during his deployment in Russia with *Sonderkommando* 4b. The “gas van” ostensibly used by this unit is described by the verdict as follows (p. 393):

*“This truck had a solid, sealed, lockable cargo box, into which the exhaust gases of the engine were piped. The vehicle could accommodate 30 persons.”*

The procedure is said to have taken five to ten minutes (*ibid.*).

### 3.8.6. LG Greifswald, Verdict of 3 July 1952

This trial was held against Bruno W. Sattler, who was head of the Gestapo in Serbia from February 1942 to the end of the German occupation. The whole case was tried at a time when Germany was still under the absolute jurisdiction of the occupational powers. Therefore the laws applied in that case followed the directives of the Allied Control Council. The verdict is less polemical than the others reviewed here, but at once considerably less sophisticated from a legal point of view (it is not even eight pages long).

A “gas van” is mentioned only briefly in the context of the alleged gassing of Serbian Jews held in the Semlin camp (although that camp’s name isn’t even mentioned, pp. 473f.):

*“In the second half of 1942 the defendant was apprised during an early conference with Dr. Schäfer that it had been announced by Berlin via a telegram that a gas van would be sent. [...] This gas van was a sealed truck into which the exhaust gases of the engine were piped. The vehicle could accommodate some 25 to 30 persons.”*

That’s all. The “facts” themselves probably originated from the telegrams contained in IMT document 501-PS (see chapter 2.2.3.). As far as can be gathered from this verdict, the defendant’s sole contribution to this was his knowledge about these things while in office in Serbia.

The mentioned Dr. Schäfer faced charges for his involvement in the alleged extermination of Jews in Serbia in a West German court of law a year later (see chapter 3.7.2.4.).

## 4. Critical Summary of Witness Testimonies

### 4.1. The Witness Problem

Before listing the incongruencies of witness statements about the alleged “gas vans,” I have to once more return to the challenges posed to the historian by the general unreliability of witness testimonies. In chapter 3.4. I already deliberated about the problematic nature of confession made by alleged perpetrators when facing a situation where “innocence” is not an option in the eyes of the prosecution, the judges and the public at large. Now I will address the problems surrounding witness statements made by victims or alleged neutral bystanders. For this I will use a recently published paper on a subsection of the issue at hand: “gas vans” in Serbia.

The alleged deployment of a “gas van” in Serbia poses a challenge to orthodox historiography, as was recently acknowledged by mainstream historian Jovan Byford. Whereas the orthodoxy accepts the generally held view that “gas vans” were deployed in the spring of 1942 to kill some 7,000 Jewish women and children held in the Semlin camp near Belgrade (see chapter 1.2.), the claim by numerous witnesses that non-Jewish Serbs – mostly resistance fighters – held in the Banjica camp were also killed in “gas vans” is disputed, as there is no corroborating documentary evidence to support this claim. Byford has done a thorough analysis as to why false “gas van” claims arose, which I would like to subsequently quote in lengthy excerpts, as it sheds a bright light on the poor quality of orthodox historiography of the Holocaust in general. Byford’s statements are ultimately revisionist in nature and absolutely devastating for mainstream historiography. One can only speculate why he did this iconoclastic, taboo-shattering work. I surmise that his work, which was “part of a research project on the post-World War II memorialization of the Semlin Judenlager [Jewish camp],” tries to maintain the Jewish monopoly for horrendous sufferings during World War II, which requires the debunking of claims about similar sufferings by non-Jews, here by non-Jewish Serbs in the Banjica camp

in Serbia. All subsequent page numbers are from Byford 2010 unless stated otherwise:

*“The alleged presence of the gas van at Banjica poses two interesting questions. There is some agreement among historians today that, when it comes to precise events, details or numbers, eyewitness testimonies are [...] ‘inaccurate with the regularity of a metronome.’ [...] And yet, historians who acknowledge the unreliability of testimonies are generally not concerned with exploring or explaining the origins or the nature of the erroneous claims found therein. Having established that a specific account of an event or a series of events is inaccurate or erroneous, they are quite content to pass on the questions pertaining to the nature of the ‘eroding,’ ‘distorted,’ ‘false’ or in some cases even deliberately fabricated memory to psychologists who are believed to have the relevant expertise and vocabulary to address them. So, the first question – how, or indeed why, does an image, in this case that of the gas van, become part of the subjective experience and life story of a small group of survivors? – is arguably one for psychologists rather than historians to consider.*

*The second question concerns the way in which erroneous information found in a small number of testimonies becomes part of historical knowledge and public memory. Why were eyewitness reports about the gas van at Banjica incorporated into accounts of the camp’s history, in spite of the glaring inconsistencies among them and the absence of corroborating evidence? How did historians and a wide range of non-historically trained writers, who cooperated in the creation and transmission of public history in postwar Yugoslav society, approach survivor testimony as a historiographic source? Linked to this question is a broader one: namely, what was the role of survivor testimony in Yugoslav historiography of Nazi concentration camps? [...]*

*Also, I argue that the origin of the claim about the gas van at Banjica can be traced to a wartime rumor, which in the postwar period, through a process of both individual and institutional transmission, became ‘solidified’ and entrenched in the official history of the Nazi occupation of Serbia.” (p. 9)*

One reason why Byford considers witness statements about “gas vans” in the Banjica camp unreliable is their inconsistency and contradictory nature. Since I later want to juxtapose these statements with

those made regarding other “gas vans,” I will quote Byford’s findings next. One claim about the Banjica “gas vans” goes as follows:

*“In the autumn of 1944, shortly after the liberation of Serbia, the Yugoslav State Commission for the Investigation of War Crimes Perpetrated by the Nazis and Their Accomplices established a special task force devoted to the investigation of crimes committed at Banjica. After a four-month-long enquiry, the task force published a report, which concluded, among other things, that ‘Hitler’s fascists’ in charge of the camp had at their disposal several specialist vehicles, in the form of smaller railway wagons, which were hermetically sealed and had a device that generated gases.”* (p. 10)

This is yet another encounter of hermetically sealed wagons, although on rails for a change, which in lack of an engine is said to have sported some “device” as a source of poison gas. These wagons are said to have been “mainly used at Semlin” to kill Jews, but also in Banjica (*ibid.*). The commission’s findings are the earliest recordings and compilations of witness statements, which should render them more reliable than later collections, yet this description of the “gas vans” – allegedly used in both camps! – is at odds with the story as it is accepted today. The indictment against August Meyszner, who was prosecuted in Serbia shortly after the war, replaced the rail wagon by a “hermetically sealed truck,” yet maintained “a specially designed device” to produce the gas (pp. 10f., and once more on p. 11).

There is even an account on cyanide gas chambers:

*“[The witness] also mentions the ‘special pastime’ of ‘Dr. Jung,’ [...] which involved ‘releasing cyanide into the gas chambers while observing its effects on the victims.’”* (p. 12)

Some witnesses described the vehicle as looking like a “furniture removal truck” (p. 23), others as an “armored truck” (pp. 15, 23); according to one witness it was a “rather large truck with the body made of wooden planks” (p. 17), “larger than other trucks” (p. 35), whereas another insisted that it was “made entirely of aluminum, coated in metal on the inside, so that no air could get inside ... instead of windows it had a grille which allowed gas to get in, gas that was mixed with the exhaust fumes” (pp. 17, 35). Whereas most witnesses claim that the vans were meant to kill the prisoners, one witness declared that they were “only meant to make the inmates unconscious, so that they would not realize that they were about to be shot,” another that the victims walked out of the truck very much alive (p. 18).



Byford summarizes the problems of witness statements in the Banjica case as follows:

*“As we have seen, some authors contend that the vehicle was used at the camp solely for the murder of Jews, or more specifically, Jewish women and children. Others claim that it was used against all categories of prisoners, including captured partisans and communist activists. The presence of the gas van at the camp is sometimes narrowed down to specific dates and selections of prisoners (for instance the execution on May 9, 1942), while in other instances it is said to have been used periodically throughout the occupation. The gas van is mostly referred to in the singular, but some of the sources claim that Germans had several such vehicles at their disposal.”* (p. 14)

*“Thus, in addition to the problem of variability among the witness accounts, many of the claims and descriptions found in them are directly contradicted or proven impossible by other forms of evidence pertaining to the gas van’s mission in Serbia. Given that we know that there was only one gas van in Belgrade, which was deployed for a limited period (around six or seven weeks), between late March and early May 1942, there clearly could not have been two or more gas vans, the vehicle could not have been seen at Banjica in early March 1942, nor could the victims have walked out of it alive. [...] In other words, survivors claim to have witnessed the killing process itself. Their version of events, however, contradicts what is known about the modus operandi of the mobile gas van in Belgrade. At Semlin, the van never even crossed the camp perimeter, and the gassing began after the vehicle crossed the pontoon bridge over the river Sava.”* (p. 18)

What Byford overlooks is that all of his claims about what we “know,” which is not founded in the documents analyzed in the previous chapter, is itself based on witness accounts, primarily made by defendants during numerous German trials. Their reliability isn’t higher than those collected by Yugoslav commissions and historians either.

Byford next tries to explain why nobody ever scrutinized these witness statements and revealed their unreliability:

*“And yet, institutions that played a dominant role in shaping official history and collective memory in postwar Yugoslav society did not reflect on the variability apparent in the testimonies or the inconsistencies found in them. They were, similarly, not troubled by*

*the uncorroborated nature of survivors' accounts. Instead, the story of the gas van was accepted unquestioningly and perpetuated, in a matter-of-fact way, as an indisputable fact about Banjica and an important entry in the catalogue of heinous crimes perpetrated there by the 'Fascists and their accomplices.'"* (p. 19)

It goes without saying that this is true for almost the entire orthodox historiography on the Holocaust. Byford elaborates further:

*"In fact, the approach [of the Yugoslav War Crimes Commission] to evidence was determined primarily by political concerns. Given that the findings were to be used to justify Yugoslavia's claim for reparations, the main criteria in the selection and evaluation of evidence was whether or not it strengthened the Yugoslav case. This meant not only that casualty figures were routinely exaggerated [...], but also that there was no real willingness to differentiate verifiable fact from rumor, at least not when rumors were more 'convenient' than material evidence."* (p. 25)

Byford's assessment is similar with respect to the Historical Archive of Belgrade's activities of compiling witness statements in later years, which wasn't interested in witness statements as such but in "details of events that were compatible with the established ideological agenda" of heroizing the Yugoslav resistance fighters (p. 29).

Even though portraying oneself as a hero and having financial consideration may have played a role, this explanation falls short of the complex motivations of the victors of World War II, which, next to simple lust for revenge and justifying one's own deeds, also included the determination to once and for all break the neck of an enemy – politically, economically, demographically, and psychologically – who, in the victors' eyes, had twice within 30 years thrown the entire world into an abyss of mass butchery and mass murder. Or to put it succinctly:

*If we had finished the job after World War I, Auschwitz would never have happened. So let's finish it now!*

Hence those Holocaust claims were welcome as a justification to prepare the world psychologically to finish the job: genocide against the German people. That was the general mood between 1942 and late 1947, which saw a huge surge of mass murder and ethnic cleansing against anything German. Yugoslavia was no exception from this, as this country ethnically cleansed its German minority with utmost brutality after the war. But even after this anti-German genocidal hysteria had subsided, the world still needed – and is still in need for – a scapegoat

for the calamities of the 20th century and a justification to keep their various spoils and, most of all, their moral high ground. In addition, a simple black and white approach to history and politics – with the good guys here and the evil guys there – facilitates the manipulation of the masses. The scarecrow “Hitler” can always be employed against any enemy in justification for a war (Slobodan Milosevic, Saddam Hussein, Mahmoud Ahmadinejad, etc.), and in comparison to Auschwitz and all that’s associated with it, any other government crime, which is in need for a cover-up, can be portrayed as being not *that* bad. This is why they all love to maintain this wartime propaganda, including the present German government, which is in constant need of proving that they are now with the good guys.

But back to Byford. He even mentions the common fact that orthodox Holocaust historiography commits outright forgeries by “editing” embarrassing witness statements:

*“Testimonies were [...] full of ‘contradictions, vague or imprecise claims, repetitions, etc.’ Editors, therefore, faced the task of eliminating all ‘inconsistencies in the data which might create doubt in the reader’s mind about what is true and what is not.’ Historians or non-historically trained writers [...] were asked to work through the testimonies and ‘flag any politically sensitive content so that the Editorial Board can take a collective decision on these issues.’”* (p. 33; as an example for such a manipulation see the case of Filip Marjanović, pp. 34f.)

By so doing, Byford goes on, the editors

*“[...] selected from each testimony those elements that confirmed existing ‘truths’ and perpetuated the dominant culture of memory. There were, therefore, no credible witnesses as such, and no survivor was a ‘living, eloquent witness to Nazi crimes’ per se. There were only usable stories, or rather fragments of testimony deemed ‘believable’ by those who selected them for publication.*

*What is especially important however is that it was precisely this kind of selectivity and the reasoning behind it that put pressure on survivors to produce ‘good’ testimonies and modify their accounts in the direction of greater ‘plausibility.’”* (p. 38)

Byford also makes some very interesting, revisionist observations about other causes for false witness statements:

*“A fear rumor is a piece of unverified information (which is not necessarily untrue) which reflects the fears and anxieties of the pop-*

*ulation among which it circulates. Bogey rumors are not uncommon in time of war. The war creates the situation of ambiguity, cognitive uncertainty and anxiety in which rumors flourish. [...]*

*The specific conditions that have been shown to be conducive to the proliferation of wartime rumor are even more pronounced in concentration camps and prisons. It is there, more than anywhere else that 'life becomes subject to the vicissitude of events over which individuals have little control,' where 'institutional channels (of communication) are destroyed or impaired' and where the flow of communication is facilitated by the 'disappearance of conventional social barriers.' (p. 21)*

Byford even gives some interesting examples shedding some revealing light on other aspects of the Holocaust:

*[...] Even while at Auschwitz, these girls remained terrified of 'mass rape at the Russian front' more than of anything else, death included." (p. 21)*

This corroborates F.P. Berg's observations that Auschwitz prisoners were more terrified of Red Army soldiers than they were of their SS guards, who are claimed to have tormented and butchered them for many years (Berg 2003a).

Byford continues:

*"Also common in concentration camps were rumors relating to specific methods of killing. In situations where death was a daily occurrence, the main source of anxiety and, by extension, the subject of rumor mongering and speculation, was the time, place and method of execution. In those contexts fear rumors took the form of accounts of particularly horrific and feared ways of dying. At the Starachowice labor camp in Poland, for instance, there was a rumor that at the nearby Bugaj forest victims were being buried alive, rather than shot. In camps throughout the Third Reich, stories about murder with electric current in water, gassing on board trains, or about victims being skinned alive or turned into soap, were rife. All these stories, however, turned out to have been unfounded. Similar examples of rumor can be found also in the Serbian context." (Ibid.)*

Byford next addresses the considerable social pressure witnesses experience to testify what everybody expects them to have experienced, that is, to cater to the historical clichés of a society:

*"They [the witnesses] were expected to comment on events that, in most instances, lay beyond their immediate knowledge. [...] in*

*bearing witness to Nazi crimes, survivors of concentration camps invariably 'have to refer to matters outside their own experience.' [...] The practice of witnessing therefore required those taking on this role to overcome the gulf that separates what they experienced and what they were summoned to witness.'* (p. 30)

*"Another route available to witnesses facing the predicament of having to generate an account of events that they did not directly experience is to produce claims that are congruent with already available [alleged] knowledge. Aaron Beim and Gary Fine have suggested that, by producing an account that corroborates rather than contradicts existing historical claims, witnesses render their story more credible and strengthen their status as a reliable witness. They do so by confirming the audience's expectation about what someone in that position could and should have seen. Therefore, although testimonies of survivors are predominantly based on personal experience, and are framed as such (this after all is the source of their cultural power), they will more often than not be embellished with 'historical claims consistent with institutionally legitimated information' of the kind 'found in textbooks or other cultural objects'. This is, for instance, why testimonies of Auschwitz survivors recorded after 1993, when Schindler's List was first shown, are more likely to contain descriptions of events resembling the film's famous shower scene than those collected before that date. Or why, in the words of Geoffrey Hartman, 'every Auschwitz survivor seems to have gone through a selection by Mengele, as if he had manned his post 24 hours a day.'"* (pp. 30f.)

As I will show now in my summary of witness statement about the "gas vans" in general, what Byford states about a "gas van" at Banjica is basically true for all "gas van" claims. Except that for these we have a few seemingly corroborating, yet, on closer look, very suspicious documents. Regarding the alleged gassings of Jews in Serbia, the evidentiary basis is actually very meager, as Walter Manoschek conceded (1995, p. 169, note 2):

*"Only a few written documents exist about the gassing of the Jews in Serbia. Of the Jewish inmates of the Semlin camp only roughly half a dozen people survived, which by now have all died. When describing the events, we essentially depend on the statements of the perpetrators during trials – except for some extant reports and interviews or letters of the survivors."*

For my summary of witness statements I have relied on witness statements as contained in various documents, as summarized by the above analyzed court verdicts, and as rendered in the general literature. Where pertinent, I will comment such claims in each subsequent subchapter.

## 4.2. Claimed Features of the Vehicles

### 4.2.1. Introduction

In his 2010 article, Byford used internal contradictions of witness accounts as one method to show that gas van claims for the murder of non-Jewish Serbs in Serbia during the war are false, all the more so as they are not supported by any documents. Although a few documents exist for the claim that gas vans had been employed in Serbia (Semlin camp, spring 1942), Poland (Chełmno) and Russia (by the *Einsatzgruppen*), a critical analysis of them reveals that they make technically impossible claims, are contradicted by other, doubtlessly authentic documents, and were probably forged immediately after the war. This leaves us with the witness statements. Following Byford's approach, I will now list the claims made about the alleged gas vans in all the extant material analyzed for this study, that is: both witness statements and the forged documents, which are basically nothing else but claims by anonymous persons. As indicated in chapter 3.7.1., this list of claims is far from complete, as I had to rely on bits of information contained mainly in verdicts and secondary literature, whose authors have not been interested in shedding any light on the alleged features of these gas vans. Kogon *et al.*, for instance, list a large number of witness statements at their disposal at the *Zentrale Stelle*, but what they tell us about them hardly ever includes anything about the van's features. Once critical researchers will be able to tap into that resource, I am convinced that the discrepancies will turn out to be even more glaring than they are already now. But already now my lists show crass divergences between the claimed features which are much more pronounced than in Byford's case. The logical conclusions to be drawn from this are obvious.

I have rendered in bold what could be considered a kind of "standard" claim, as it is the most frequently found description in the various court verdicts.

#### 4.2.2. Vehicle Models

- **Saurer** (501-PS; IMT, vol. 7, p. 573; 2348-PS, IMT vol. 30, p. 256; LG Köln, 20 June 1953, pp. 153f., 164; LG Hannover, 7 June 1966, p. 621)
- Diamond (501-PS, telegram 15 June 1942; Kogon *et al.* 1993, p. 64; LG Hannover, 7 June 1966, p. 622)
- American (Beer 1987, p. 412)
- foreign (LG Bonn, 23 July 1965; LG Darmstadt, 18 Apr. 1969, p. 93)
- Opel (Beer 1987, p. 414; Klee 1991, p. 69)
- Renault (Kogon *et al.* 1993, p. 77)
- Daimler Benz (IMT vol. 19, p. 573; Choumoff 1987, p. 38)
- Magirus Deutz (Falborski; Srebrnik; Fleming 1984, after p. 92)
- Russian Ford truck (LG Kiel, 14 June 1974, p. 662)

Usually neither witnesses nor verdicts make any statements about the make or model of the vans. In most cases such claims are probably based on the extant documents discussed in chapter 2.2. When discussing the makes and models used as gas vans, Beer concedes that, apart from what we have in the documents, information is scant and inconsistent. He claims that this mishmash of vehicles existed only during the early phase of the gas vans' deployment, caused by "difficulties existing at the beginning when organizing chassis" (1987, p. 414). Once things got properly organized, though, that is in late 1941, "the entire order was with regards to Saurer vehicles" (*ibid.*). He finds documentary support for this in the Becker letter, which in its second sentence distinguishes between a "first group" of vehicles and a "second group" consisting of Saurer trucks.

Already in chapter 2.2.6. (p. 87) I have pointed out that a systematic approach to mass murder vans killing with exhaust gases would have required the use of vehicles equipped with gasoline engines, like the ubiquitous Opel Blitz. Beer, however, maintains that such vehicles were used only at the beginning of the haphazardly organized project, while they were later replaced with vehicles equipped with Diesel engine during the more systematic phase of the project. If anything, this observation undermines his entire theory (see chapter 1.3.1.).

### 4.2.3. General Appearance

- large former refrigerator truck (Rosenberg 1985, p. 36; similar LG Kiel, 26 Nov. 1965, p. 429); with a huge red cross (Sherman-Zander 1984, p. 49)
- all metal cargo box (Kogon *et al.* 1993, p. 60; LG Hannover, 7 June 1966, p. 623)
- camper van with windows, curtains and shutters painted on, including a chimney (Loewenstein 1961, p. 51; cf. the Becker letter 501-PS)
- black vans (Podchlebnik; Bednarz 1946c, p. 62; LG Stuttgart 15 Aug. 1950, p. 200f.; Smoliar 1966, p. 67; Falborski, Appendix 9)
- hermetically sealed yellow van (Kazimierz Czyzewski, Höß Trial, vol. 35, p. 163)
- green truck, like those delivering cigarettes (Lanzmann 1985)
- grey-green vans (Kogon *et al.* 1993, pp. 57, 80)
- grey truck like a mail van (Kogon *et al.* 1993, p. 72)
- grey Saurer truck with ten benches for the inmates to sit on (Manoschek 1998, p. 230)
- very big armored vans (Lanzmann 1985)
- trailers attached to trucks (Johnson/Reuband 2005, p. 237)
- ordinary truck, like a box car, possibly with windows (NMT, vol. 4, p. 301)
- **like a moving van, (dark) grey** (Kogon *et al.*, pp. 57, 61-63, 72; *The People's Verdict* 1944, p. 29; Lanzmann 1985; LG Hannover, 7 June 1966, p. 619; with a high vaulted roof; without color: LG Stuttgart, 8 Nov. 1949, pp. 200, 231, 239; LG Karlsruhe, 20 Dec. 1961, p. 100; LG Koblenz, 21 May 1963, p. 194; LG Kiel, 26 Nov. 1965, p. 429; LG Wuppertal, 30 Dec. 1965, p. 513; LG Frankfurt/M., 12 Mar. 1966, p. 344; and other verdicts)
- **interior lined with sheet metal, wooden floor grate** (*The People's Verdict* 1944, pp. 8, 16f., 49, 69, 85; Bednarz 1946c, pp. 25f.; LG Bonn, 23 July 1965; Kogon *et al.* 1993, pp. 60, 86; 2 m high; *Soviet Government* 1945, p. 227; similar: LG Koblenz, 21 May 1963, p. 194, and many other verdicts)
- cargo box of 7 to 8 m length, grey, lined with sheet metal, wooden floor grate with two pipes beneath (LG Kiel, 28 Nov. 1969, p. 284)
- ditto, grey normal truck, like a bathroom, with straw mat (Sakowska 1993, pp. 162f.)



- hermetically closed box of 5 m × 2.5 m × 2.5 m, like railway car; lined with galvanized sheet iron, wooden floor grate; door lined with rubber and automatic lock; two metal pipes with frequent holes spreading the gas; rubber hose connected to engine exhaust pipe (IMT, vol. 7, pp. 572f.; similar *The People's Verdict* 1944, pp. 49, 85)
- airtight cargo box lined with sheet metal at the outside, a gas inlet near the driver's cabin, and benches for the victims to sit on (LG Berlin, 14 Aug. 1978, p. 500)
- false windows (*The People's Verdict* 1944, pp. 16f.: "appearance of motor buses"; LG München I, 14 July 1972, p. 408; 29 Mar. 1974, p. 601)
- false windows and closed curtains (LG München I, 19 Dec. 1980, p. 251)
- prisoner transport van, 1.5 to 2 metric tons (Choumoff 1987, p. 42; *The People's Verdict* 1944, p. 50)
- 5 or 7 ton, grey (*The People's Verdict* 1944, pp. 8, 16, 85)
- 3 ton van with cargo box 4 m × 2 m (Beer 1987, pp. 412-414)
- two smaller vans (Beer 1987, p. 413)
- tiltable cargo box for fast unloading (Kogon *et al.* 1993, p. 70)
- stationary gas chamber (State of Israel, session 46, part 6; 19 May 1961)

And here is my favorite, attested to by George Goiny-Grabowski regarding alleged gas vans deployed in Auschwitz:<sup>122</sup>

*"The gas vans had an image showing a human head which kept its nose closed with one hand."*

Or in other words the vans allegedly had a warning sign like the one designed by me on the right warning everyone:

*Danger! Stinker on the road!*

Please forgive me my black humor.

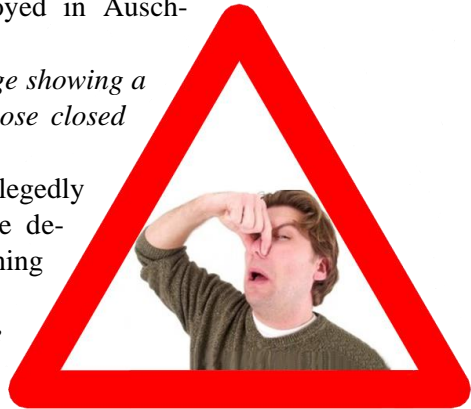

<sup>122</sup> Archives of the Auschwitz Museum, Collection "Statements," vol. 61, p. 167.

A frequent claim made in witness accounts which is not listed here is that the “gas vans” had a *hermetically sealed or airtight* cargo box (see e.g. *The People’s Verdict* 1944, pp. 8, 17, 50, 65, 85, 89, 110; Kogon *et al.* 1993, pp. 53, 57, 59; Beer 1987, p. 403; LG Stuttgart, 8 Nov. 1949, p. 239; LG Wiesbaden, 24 Mar. 1952, p. 354; LG Karlsruhe, 20 Dec. 1961, p. 100; LG Bonn, 30 Mar. 1963, pp. 230f., 277; LG Koblenz, 21 May 1963, p. 194; LG Frankfurt/M., 12 Mar. 1966, p. 344; LG Hannover, 7 June 1966, pp. 616, 619; LG Stuttgart, 15 Sep. 1967, p. 565; LG Kiel, 11 Apr. 1969, p. 33; LG München I, 15 Nov. 1974, p. 287; LG Berlin, 14 Aug. 1978, p. 500; LG München I, 19 Dec. 1980, p. 251; interestingly, the verdict by LG Darmstadt, 18 Apr. 1969, pp. 93f., speaks both of an airtight and a merely “almost” airtight cargo box).

The fact that many witnesses and court verdicts speak of a truck resembling a moving van could be interpreted as “converging evidence” for the truth of such claims. However, at closer inspection the opposite turns out to be true. Moving vans have two distinct features: First the area above the driver’s cabin is also used as storage space (see Illustrations 12 to 17 in Appendix 1). Second, in order to maximize the space available for the storage of furniture, the cargo box was always considerably higher than wide, often even higher than average trucks: 2.50 m and more.

In contrast to this, the thirty cargo boxes ordered from the Gaubschat Company most definitely did not include the space over the driver’s cabin and were only 1.70 m high to a length of 5.80 m. With an assumed width of some 2.30 m, the Saurer trucks with Gaubschat cargo boxes would have looked from the rear like Illustration 7, whereas a moving van’s rear view would have looked like Illustration 8. In Illustrations 9f. I have juxtaposed the side view of a Gaubschat Saurer (my drawing) and a hypothetical Saurer moving

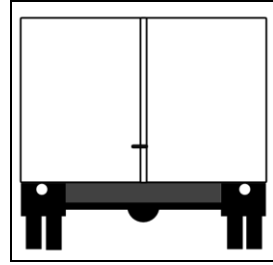

**Illustration 7:**  
Schematic drawing of rear view of a Saurer truck with Gaubschat cargo box, 2.30 m wide, 1.70 m high.

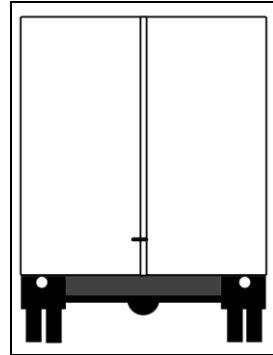

**Illustration 8:**  
Schematic drawing of rear view of the same truck with furniture cargo box, 2.30 m wide, 2.70 m high.

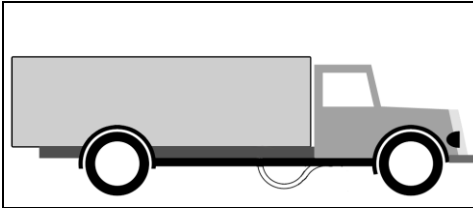

**Illustration 9:** Saurer truck with Gaubschat cargo box and exhaust metal hose; author's drawing.



**Illustration 10:** Saurer truck as moving truck; artwork (see Illustration 17, p. 278).

This juxtaposition reveals it: the Saurer trucks with Gaubschat cargo boxes did not resemble a moving truck at all.

truck taken from the artwork shown in Illustration 17 (p. 278). It is therefore clear that these long Gaubschat cargo boxes were unusually *low*. There is no way anyone could have taken those Gaubschat Saurers for moving trucks.

The conclusion to be drawn from this is that we are dealing here with a cross-fertilization of the vast majority of testimonies, which may have been inspired by claims made during the Soviet wartime show trials, but in particular during the postwar trials in Poland by the evidently false statements of witnesses like Falborski, who has seen a real moving truck but assigned a function to it which it never had (see chapter 3.6.2.).

The claims about internal sheet metal lining and wooden grates, on the other hand, are probably a mere repetition of what can be found in the extant Gaubschat correspondence and any encounters with the real Saurer trucks equipped as such. The sheet metal lining could in many cases also stem from mere cross-fertilizations from witnesses who had seen the Ostrowski moving truck, whose interior was also lined with sheet metal and which had been falsely identified as a “gas van” by several witnesses. Hence finding these features repeated in numerous witness accounts cannot surprise either.

Omitted from this list are witness claims about gas vans allegedly deployed in Serbia to kill Serbs, as such claims have been disputed as inventions by Byford (2010). Also omitted were witness statements about the characteristics of some very early gas vans allegedly used during the euthanasia program, which is a different topic altogether. These are said to have been hermetically sealed trailers with the inscription “Kaiser’s Coffee Shop” and drawn by a tractor-trailer, using carbon monoxide from steel bottles as the source of poison gas (Beer 1987, pp.

404-407, 417; as a van without tractor in LG Stuttgart, 15 Sep. 1967, p. 565). This theme was already mentioned by the Polish judge Bednarz in 1946, where it may have started its career as a converted truck of “Kaiser Kaffe[e] Wien” (Bednarz 1946c, p. 25). I am not going to scrutinize this puerile and ridiculous theme any further, since not a shred of documentary evidence exists for it. Carlo Mattogno has exposed this pseudo-historical claptrap in the first chapter of his book on Chełmno, to which I refer the interested reader (2011a).

#### 4.2.4. Capacity

- 170 (Srebrnik, large type)
- 150-175 (Bednarz 1946c, pp. 23, 48 [large])
- 130 (Bednarz 1946c, large type, p. 62)
- 100-120 (Srebrnik, small type)
- 100 (Rosenberg 1985, p. 36; Kogon *et al.* 1993, p. 71; Browning 1983, p. 82)
- 80-100 (Beer, Appendix 10; Bednarz 1946c, p. 23 [small])
- 80-90 (Podchlebnik; Bednarz 1946c, pp. 43, 48, 62, 72 [small type])
- 70-90 (Kogon *et al.* 1993, p. 98)
- 80 (Blumental 1946, p. 240; Kogon *et al.*, p. 64)
- 70-80 (IMT, vol. 7, pp. 573, 575; *The People’s Verdict* 1944, p. 17; LG Kiel, 26 Nov. 1965, p. 429; LG Stuttgart, 8 Nov. 1949, p. 231)
- 60-70 (*The People’s Verdict* 1944, pp. 65, 70; Friedlander/Milton 1993, p. 182)
- 50-80 (with luggage, Manoschek 1998, p. 230; LG Karlsruhe, 15 Dec. 1949, pp. 7, 24)
- at least 60 (LG Wuppertal, 30 Dec. 1965, p. 513)
- **50-60** (NMT, vol. 4, pp. 210, 545; Beer 1987, pp. 412f.; large, Kogon *et al.* 1993, pp. 54, 57, 59, 64, 69, 88; Browning 1983, p. 82; LG Stuttgart, 11 June 1968; Benz/Distel 2009, pp. 575f.; Kazimierz Czyzewski, Höß Trial, vol. 35, p. 163; LG Koblenz, 21 May 1963, p. 194; LG Frankfurt/M., 12 Mar. 1966, p. 344; LG Hannover, 7 June 1966, p. 622, for Saurer; LG Stuttgart, 11 June 1968, p. 412; LG Dortmund, 16 Jan. 1969, p. 680; LG Kiel, 11 Apr. 1969, p. 39; 28 Nov. 1969, p. 284)
- 40-60 (Klee/Dreßen/Rieß 1988, p. 75)
- several dozen (*The People’s Verdict* 1944, p. 50)
- 30-50 (Beer 1987, p. 414)
- 40-45 (LG Darmstadt, 18 Apr. 1969, pp. 94, 97)

- 35-40 (Kogon *et al.* 1993, p. 84)
- 30-40 (NMT, vol. 4, p. 213)
- at least 30 (LG München I, 19 Dec. 1980, p. 251)
- 30 (Beer 1987, pp. 411f., 414; Kogon *et al.* 1993, p. 61; LG Karlsruhe, 20 Dec. 1961, p. 100; LG/BG Neubrandenburg, 22 Feb. 1961, p. 393)
- 25-30 (small, Kogon *et al.* 1993, p. 54; LG Hannover, 7 June 1966, p. 622, Diamond; LG Greifswald, 3 July 1952, p. 474)
- 25 (with luggage; LG Köln, 20 June 1953, p. 153; Kohl 2003, pp. 69f.)
- 15 (small), 30 (large) (NMT, vol. 4, p. 301)
- 15-25 (NMT, vol. 5, p. 688)
- up to 14 (Artur Meyer, Archives of the Auschwitz Museum, Collection “Statements,” vol. 93, pp. 23, 23a)

Although next to nothing is known about the technical data of some of the claimed gas vans, the 30 Saurer trucks equipped with Gaubschat cargo boxes allegedly used for gassings are well defined. As I have described elsewhere (p. 71), loading a Saurer truck with nine to ten persons per m<sup>2</sup>, resulting in a capacity of 120 to 133 persons, would have exceeded the vehicle’s maximum permitted load of 5 tons considerably by some 50% ( $\pm 10\%$ ). It also appears impossible to cram so many unwilling individuals so tightly. Hence, claimed packing densities beyond 6 persons per m<sup>2</sup>, amounting to some 80 persons in the entire cargo box with a total of some 4.8 tons, must be regarded as technically highly unlikely.

#### 4.2.5. Duration of the Gassing Procedure

- 20-30 min. (Rosenberg 1985, p. 36; Loewenstein 1961, p. 51)
- 15-30 min. (LG Darmstadt, 18 Apr. 1969, pp. 94f.)
- 15-20 min. (Sakowska 1993, p. 166; Kogon *et al.* 1993, p. 63; LG Kiel, 26 Nov. 1965, p. 430; Kohl 2003, pp. 69f.; LG Koblenz, 30 Dec. 1965, p. 513; LG Kiel, 14 June 1974, p. 663)
- 15 min. (LG Köln, 20 June 1953, p. 153; Benz/Distel 2009, pp. 575f.; LG Koblenz, 21 May 1963, p. 194)
- 10-15 min. (NMT, vol. 4, p. 206; IMT, vol. 4, p. 322; LG Bonn, 23 July 1965, p. 232; LG Kiel, 28 Nov. 1969, pp. 284, 286)
- 12 min. (Kogon *et al.* 1993, pp. 58, 87)
- 10 min. (NMT, vol. 4, p. 302; Kogon *et al.* 1993, pp. 58, 86; Klee/Dreßen/Rieß 1988, p. 201)

- 7-10 min. (*The People's Verdict* 1944, p. 17)
- 7-8 min. (NMT, vol. 4, p. 213; LG Frankfurt/M., 12 Mar. 1966, p. 344)
- several minutes (*The People's Verdict* 1944, p. 8)
- a few / 5-10 min (Kogon *et al.* 1993, p. 65; LG Karlsruhe, 20 Dec. 1961, p. 100; LG/BG Neubrandenburg, 22 Feb. 1961, p. 393)
- 6-7 min. (Podchlebnik)
- 5-7 min. (Kogon *et al.* 1993, p. 70)
- at least 5 minutes (LG München I, 29 Mar. 1974, p. 601)
- 4-5 min. (Bednarz 1946c, pp. 22, 60)
- 2-3 min (Kogon *et al.* 1993, p. 98)

#### 4.2.6. Poison Source

- Diesel exhaust gases (*The People's Verdict* 1944, pp. 8f., 13, 17, 49; plus any reference to Saurer trucks, see chapter 4.2.2.)
- gas and exhaust fumes from burning gasoline in the engine (Kogon *et al.* 1993, p. 59); Otto/gasoline engine (*ibid.*, pp. 77, 98; LG Kiel, 26 Nov. 1965, p. 430; LG Kiel, 14 June 1974, p. 662)
- **exhaust gases** (Rosenberg 1985, p. 36; Loewenstein 1961, p. 51; Sherman-Zander 1984, p. 50; NMT, vol. 4, p. 448; Manoschek 1998, p. 230 (switchable); IMT, vol. 7, p. 573; Beer 1987, pp. 410, 412; Kogon *et al.* 1993, pp. 60f., 63f. 86f.; LG Munich 15 Nov. 1974; LG Wuppertal, 30 Dec. 1965, p. 513; LG Frankfurt/M., 12 Mar. 1966, p. 344, and many others)
- exhaust gases *and* other gases (Choumoff 1987, p. 35; Klamper 1991, p. 33)
- exhaust gas from engine fueled with methanol (Kazimierz Grabowski, Höß Trial, vol. 26, pp. 32f.) or maybe with other additives (Bednarz 1946c, p. 25)
- carbon monoxide (NMT, vol. 4, p. 441)
- bottled carbon monoxide (Rückerl 1977, p. 267; Morsch/Perz/Ley 2011, p. 180)
- Zyklon B dumped in from the driver's cabin (Choumoff 1987, pp. 39, 42f.; Klamper 1991, p. 33)

Some witnesses claimed separate gas-producing devices, which are listed in the next subchapter, together with the various means of piping the poison into the cargo box.

#### 4.2.7. Gassing Procedure

The standard version is a flexible, removable metal hose attached to the exhaust piped during a gassing operation, which led the gases into the cargo box. However, there is a plethora of other versions about the way the gas was produced and piped into the cargo box:

- from a device in the driver’s cabin, upon pressing a button piped from there into the cargo box (Sakowska 1993, pp. 162f., 166)
- a valve in the driver’s cabin, turned on during a transit of 200 m (Kogon *et al.* 1993, p. 98)
- a lever in the cabin, operated by the driver (LG Köln, 20 June 1953, p. 153; LG Dortmund, 16 Jan. 1969, p. 680; LG Kiel, 14 June 1974, p. 662; LG München I, 19 Dec. 1980, p. 251)
- a lever outside the cabin (Manoschek 1998, p. 230)
- gassing device inside of truck, operated from the driver’s cabin during transit (LG Stuttgart 15 Aug. 1950, p. 200)
- custom built device by Auschwitz motor pool (Jan Dziopek, Höß Trial, vol. 8, p. 109)
- exhaust pipe forking mechanism (Falborski, Appendix 9; Kohl 2003, pp. 69f.)

The statements claiming that the vans had some fancy piping and/or wiring allowing the poison gas to be “turned on” by opening a valve or pushing a button inside the driver’s cabin are a curiosity. This runs not only contrary to most other witnesses, but it would also have been quite a technical feat to revamp a normal truck in such a drastic way that the flow direction of the exhaust gases (let alone gasses produced otherwise, as some state) could have been handled from within the driver’s cabin. It shows that the fanciful fantasies of these witnesses were devoid of any basis in reality.

The problem is, however, that the witnesses claiming these fanciful devices aren’t just some individuals. One of them, claiming a button in the cabin (Sakowska 1993, pp. 162f., 166), actually stems from one of the most important “sources” we have about Chełmno: the so-called “Szlamiek” Report already mentioned before (p. 241), which is a testimony allegedly given by a former inmate who is said to have been a grave digger in Chełmno and who allegedly managed to flee and subsequently had his version recorded in the Warsaw ghetto in early 1942.

Orthodox historian Peter Klein posits – without proof – that the vehicle described in this report was an undefined early version which op-

erated with bottled carbon monoxide (in Morsch/Perz/Ley 2011, p. 180), but such bottles don't have buttons to turn them on either. Besides, bottled CO is said to have been used only in the context of the euthanasia action during the years 1939 to 1941 in a tractor-trailer setup sporting the infamous "Kaiser's Coffee Shop" sign (Beer in *ibid.*, p. 158; Beer 1987, pp. 404-406), which is not what the report describes. Apart from the button (and straw mats in the cargo box), the report's description clearly follows the stereotypical pattern of the claimed "moving truck" type gas vans with grey color, hermetically closing double doors, wooden grates, sheet metal lining, observation window, cargo box lamp (maybe inspired from the Gaubschat correspondence).

The other testimony stems from Walter Piller, the former deputy commander of the Chelmno camp (Kogon *et al.* 1993, p. 98). According to him the exhaust gases from a gasoline engine were piped into the cargo box using a valve in the driver's cabin, killing the victims within two to three minutes (see chapter 3.6.2.2.). He should have known better.

Another frequently mentioned, yet utterly useless feature was some fanciful piping inside the van to distribute the gas (*The Peoples' Verdict* 1944, p. 49; IMT, vol. 7, pp. 572f., LG Bonn, 30 Mar. 1963, p. 230; LG Hannover, 7 June 1966, p. 619; LG Darmstadt, 18 Apr. 1969, p. 93; LG Kiel, 28 Nov. 1969, p. 284; Kogon *et al.* 1993, p. 54; LG Frankfurt/M., 19 Mar. 1971, p. 138; Kohl 2003, pp. 69f.; Sakowska 1993, pp. 162f.), one of which is said to have had the gas entry not through the floor, as is the standard method, but at the front (Kogon *et al.* 1993, p. 77).

According to the standard version, the gassing itself is said to have occurred during transit, that is to say, while the van was moving. Not all witnesses agreed with this, though, as some examples show:

- drive to ditch, then turn on the gas while stationary (Kogon *et al.* 1993, p. 58; LG Koblenz, 21 May 1963, p. 194; Benz/Distel 2009, pp. 575f.; Kohl 2003, pp. 69f.; LG Wuppertal, 30 Dec. 1965; p. 513 (optional); LG Frankfurt/M., 12 Mar. 1966, p. 344; LG Kiel, 11 Apr. 1969, p. 33; 28 Nov. 1969, p. 286; LG München I, 29 Mar. 1974, p. 601)
- gassing in stationary van before departure (Kogon *et al.* 1993, pp. 65, 66, 69-71, 86 (2 ×), 87; Lanzmann 1985; Podchlebnik; Srebrnik; Bednarz 1946c, p. 60; LG Karlsruhe, 20 Dec. 1961, pp. 100, 118; LG Bonn, 23 July 1965, pp. 231f.; LG Kiel, 28 Nov. 1969, p. 284; LG München I, 15 Nov. 1974, p. 287)



This raises the question: What was the point of a mobile gas chamber, if it was used while stationary only? Or as the Dortmund District Court put it in its verdict of 16 Jan. 1969 regarding the claimed gas van murders in the Semlin camp in Serbia (case 700; Rüter *et al.* 1968ff., vol. 31, p. 683):

*“There was finally no plausible reason to commit the killing in the camp [while stationary] and to let the engine run for an extended period of time, if a longer driving route was available.”*

It must also be kept in mind that the vast majority of gas vans were Saurer trucks with Diesel engines, which, when running idly, will not kill anyone within half an hour, and even when moving they would need a heavy load to accomplish that, if at all possible. This would have required continuously driving up a steep mountain, for instance, but such mountains are few and far between in most Soviet areas occupied by the Germans during WWII.

#### 4.2.8. The When, Where, and How Many

Since by definition “gas vans” are mobile, they could have been deployed just about anywhere, and so we can find witnesses claiming to have seen them pretty much at any time and any place, so we gain little by analyzing witness statements in this regard.

Many witnesses do not specify when and where exactly they made their observation. Usually witnesses claim to have seen only one such vehicle at a time. In some cases time and location of such an observation can be derived indirectly from the biographic data of alleged perpetrators, as it can usually be determined when they were deployed in which region with which unit. Although Kogon *et al.* try to determine with such data how many gas vans had been deployed by which German unit (1993, pp. 56-70), this attempt is necessarily futile in the face of the contradictory and unreliable nature of the anecdotal evidence used. It is finally turned *ad absurdum* when Kogon *et al.* claim that a gas van was even deployed at the concentration camp Majdanek (p. 72), which allegedly had numerous stationary gas chambers and hence no need for mobile ones. And indeed, in her orthodox monograph about the Majdanek camp, the German orthodox historian Barbara Schwindt claimed that the Majdanek “gas van” story is untrue and merely based on the “spreading of errors” caused by a lack of knowledge about the camp’s history (Schwindt 2005, p. 13). However, just six years later the

Polish Majdanek specialist Tomasz Kranz<sup>123</sup> maintained that “gas vans” had really been deployed at Majdanek, although he referred only very vaguely to “circumstantial evidence” in support of this claim (Morsch/Perz/Ley 2011, p. 219). This shows that the Holocaust orthodoxy itself is mightily confused about this issue.

The same absurdity can be observed regarding the Auschwitz camp. Although Auschwitz is said to have been replete with stationary gas chambers and therefore shouldn’t have had a need for mobile ones, there is an abundance of witnesses claiming the use of gas vans in that camp as well.<sup>124</sup> One of those witness claims about a warning sign “dangerous stinker on the road” I have quoted in chapter 4.2.3. (p. 256). An even greater nonsense is claimed for the Mauthausen camp, where a stationary gas chamber was also said to have been in use (see chapter 5.1. for more details).

The problem is that one can prove just about anything with eyewitness testimonies about events of the Second World War. A case in point is the eyewitness account by German citizen Hilde Sherman-Zander, whose testimony already sticks out because she claims to have seen not one, not two, but actually a long file of gas vans deployed to help clear the Riga ghetto (1984, p. 49):

*“K. and his helpers spoke uninterruptedly. ‘You will be fine. You will go to a fishery village, Dünamünde, close to here. There will be easy work for you in closed rooms. In the canning factory. You will have to mend nets and... you will be fine...’*

*Suddenly a motorcade drove into the ghetto: refrigerator trucks which, completely insulated, are used to transport meat. But these carried a huge red cross. [...] The refrigerator truck left the ghetto in a long row.”*

Note that the Red Cross sign is not attested to by any other witness as far as I know. The witness may have derived that from the various published images in the German newsmagazine *Der Spiegel* (see chapter 2.1.). The witness continues (p. 50):

*“What the Latvian men told us made our blood freeze in our veins: No fishery village Dünamünde ever existed. No canning factory. The refrigeration trucks with the Red Cross were mobile gas*

<sup>123</sup> Kranz is currently the head of the research department at the Majdanek camp museum; see Kranz 2007.

<sup>124</sup> See [www.deathcamps.org/gas\\_chambers/gas\\_chambers\\_auschwitz\\_testi.html](http://www.deathcamps.org/gas_chambers/gas_chambers_auschwitz_testi.html); cf. Robert J. van Pelt’s elaboration on that in Morsch/Perz/Ley, p. 215f.

*chambers! With exhaust pipes turned into the interior, with carbon monoxide the people had been murdered.”*

First of all, a village named Dünamünde did indeed exist; this is the German name for Daugavgrīva (which has the same meaning, *i.e.* the mouth of the Dūna/Daugava river), which is in fact a neighborhood in northwestern Riga.<sup>125</sup> Next, this testimony is contradicted by orthodox historiography, which insists that gas vans were not used during the clearing of the Riga ghetto (Angrick/Klein 2009, p. 334, note 3):

*“The deployment of gas vans in this operation is not documented. Latvian policemen from Victor Arajs’s auxiliary security police who were deployed during Operation Dünamünde spoke exclusively of shooting operations. Because a good many of them were transferred to Minsk in spring 1942 in order to guard the arrival of Viennese Jews at the extermination camp Maly Trostenez [...], where gas vans were used, the difference in their actions was quite apparent to them [...].”*

The Chełmno camp is an exception in this regard, as the alleged deployment of gas vans there is narrowly defined in time and space. Here the majority of witnesses claimed either two or three deployed gas vans, although inconsistencies can be found here as well (see Mattogno 2011a).

#### 4.2.9. Conclusion

As unsettling as these witness reports may be by their sheer number, their discrepancies are just as unsettling, or should be for the critical historian. Many witnesses’ descriptions are very vague, whereas others describe trivial events which were later distorted and gave rise to ominous rumors whose origins have to be seen in war propaganda. Other witnesses have shaped their testimony according to what they have learned only after the war. Karl Loewenstein is a classic example for this. Although his testimony is very detailed (1961, p. 51), it contains not only absurd aspects (trucks with painted windows, curtains, shutters plus a fake chimney to make it look like a trailer home), but he actually quotes the Becker letter (of 501-PS) in full right after his own statement, which clearly shows where he got his fanciful fantasies from. Again others clearly told what they were expected to tell, like the Polish witness Falborski (see chapter 3.6.2.3.).

---

<sup>125</sup> <http://en.wikipedia.org/wiki/Daugavgr%C4%ABva>.

Be that as it may, when reading the witness statements, it is striking that according to many of them the “gas vans” were equipped with a *hermetically sealable* cargo box. Since this feature renders a long-term operation of the engine impossible or would lead to the destruction of the cargo box, and because there is no way around this physical reality, we are confronted with a problem.

It is, on the other hand, strange that to my knowledge only one witness ever uttered a word about the effects of the exhaust gases’ high *temperature* (see chapter 1.3.1.). It was the Polish witness Mieczysław Żurawski who stated: “I may mention that bodies found next to the exhaust pipe were burnt” (Bednarz 1946c, p. 62).

Hence, on top of the potentially noxious content of the exhaust gases, the cargo box would also have been a huge cooker, in which those doomed to die would have been exposed to the hot exhaust gases, which by itself would have led to their eventual, although very slow demise. The consequences of this thermal effect would have been visible on the corpses and would have increased the horror of the spectacle presenting itself to the commandos ordered to drag the corpses out of the cargo box after the door had been opened. We note that the analyzed documents remain silent about this point as well.

After critically reviewing witness claims about the murder of non-Jewish Serbs with gas vans in wartime Serbia, orthodox historian Byford rejected them as unconvincing (see chapter 4.1.).

After scrutinizing the entire plethora of evidence about the remaining gas van claims, we cannot but join Byford in his verdict.

Mainstream historian Prof. Dr. Michel de Boüard, himself an inmate of the Mauthausen concentration camp during the war, stated the following about the quality of survivor stories, which is just as true regarding the gas vans (Lebailly 1988):

*“I am haunted by the thought that in 100 years or even 50 years the historians will question themselves on this particular aspect of the Second World War which is the concentration camp system and what they will find out. The record is rotten to the core. On one hand a considerable amount of fantasies, inaccuracies, obstinately repeated (in particular concerning numbers), heterogeneous mixtures, and generalizations and, on the other hand, very dry critical [revisionist] studies that demonstrate the inanity of those exaggerations.”*

### 4.3. A Hypothesis on the Origin of “Gas Van” Claims

If it is true that it is impossible to operate a “gas van” as described by piping exhaust gases into a hermetically sealed cargo box, why did so many witnesses claim or even insist that the cargo box was indeed sealed? How could the witnesses *en masse* claim something that cannot be true?

Killing with poisonous gases comes with the natural assumption that the gases thusly used must be very dangerous indeed. It is therefore only logical to assume that those outside the gassing locale who are performing the gassing or who are mere bystanders need protection from this very poison, which is achieved by hermetically sealing the gassing locale. This assumption is reasonable for the use of Zyklon B and other poisonous gases, and it is correct also for the use of carbon monoxide in gas chambers contained within closed buildings, where the operators themselves are inside the same building, although in different adjacent rooms.

The situation is of course different for gassings with carbon monoxide in “gas vans” or freestanding rooms, as is said to have been the case in the Action Reinhardt camps. Here any escaping carbon monoxide would have quickly been diluted by the surrounding air and hence rendered harmless.

It is an irrefutable fact, though, that the sheer amount of gas produced by the engines rendered those claimed gassings technically different from those where only a minute amount of gas is said to have been applied once, as in the case of Zyklon B. Neither the mobile nor the stationary CO gas chambers could have been hermetically sealed (although witnesses claimed sealed gas chambers also for the stationary kind<sup>126</sup>).

It may therefore be surmised that the witnesses added to their story not something they had observed but what they assumed due to prevailing clichés and fantasies: poison gas must be sealed off hermetically. It also sounds more dramatic, as the poison gas appears more dangerous than a substance that can escape the chamber without harming anyone.

If it is moreover a fact that the Germans all over Europe used vans and trucks fueled with wood gas generators, how come that nobody ever claimed that their generator gas was used for mass murder? The answer to this question may also shed light on the origin of the “gas van”

---

<sup>126</sup> See Mattogno 2004, Graf/Kues/Mattogno 2010 and Graf/Mattogno 2003 for details.

story. It is safe to say that many, if not all, of the witnesses testifying regarding the “gas vans” had seen German transport vehicles equipped with wood gas generators. Since this technology was introduced by Germany *en masse* only during the war, it was a new and unknown technology particularly to most people in the occupied territories. In this context it is interesting to note the following fact:

a) In trucks and vans the wood gas generators were frequently placed between the driver’s cabin and the cargo box, frequently making it look like a part of the cargo box (see the two illustrations showing Saurer trucks equipped with gas generators on pp. 102 & 103).

b) The generator was connected to the engine with a pipe leading the fuel gas into the engine.

c) Before being able to drive off and sometimes in mid-operation, the driver or co-driver had to either “start” the generator by lighting its fire, or he had to check its proper operation. This required manipulating of valves and a fan driving the fuel into the engine.

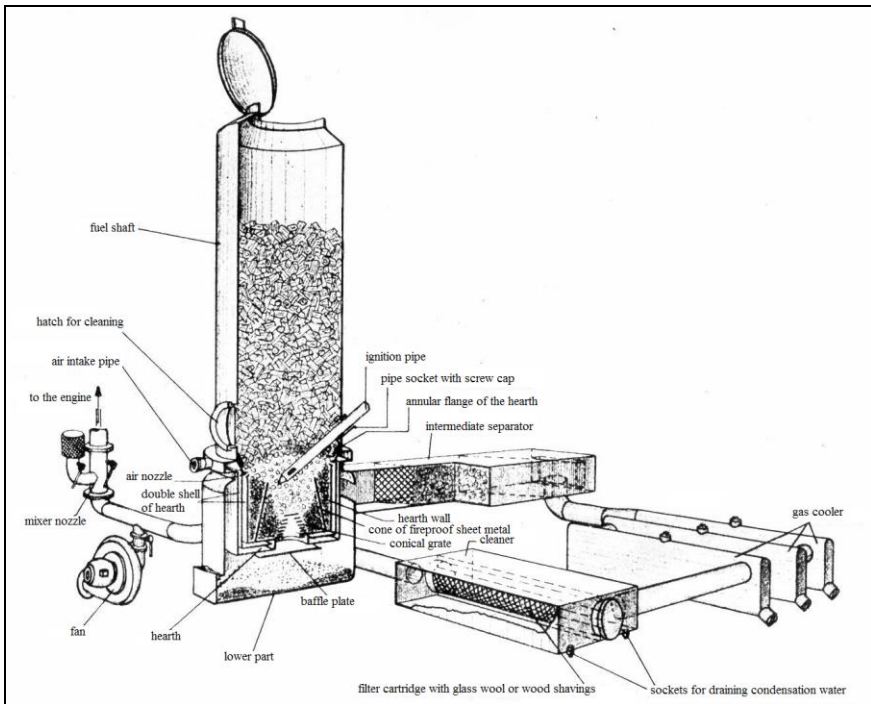

**Illustration 11:** Design of an Ostmark producer gas generator. (Rudolf 2003, p. 464; descriptions translated)

d) The danger of the extremely poisonous wood gas required special caution, which was emblazoned on labels affixed to the device itself.

So imagine the following scene observed by a later “witness” who has never heard of producer gas vehicles: An SS man goes to the back of his van’s cabin and starts manipulating a device equipped with skulls and bones signs, “Poison!” and “Danger!” words. This device is directly attached to the van’s cargo box. A pipe is leading from the engine to bottom of that device (or vice versa, but how could the witness know which way the gas flowed?).

*Et voilà*: you have a “gas van witness.”

There are, of course, other vehicular occurrences which might have contributed to the rumor about gas vans. In chapter 2.2.6. I elaborated on the probable purpose of the special vehicles ordered by the RSHA and manufactured by the Gaubschat Company. If my hypothesis is correct that they were vans to transport corpses, then numerous witnesses must have seen how these corpses were eventually unloaded. It seems almost inevitable that at least some of these witnesses must have thought or later concluded from stories spread by rumors, by the media, by the judiciary and by historiography, that what they had experienced was the last step of a gas van murder.

German disinfestation vehicles as mentioned in chapter 2.4. may have added to the rumor, in particular if some of them used their own hot exhaust gases for hot air disinfestation by piping them into their disinfestation compartment via a metal hose.

Although it is possible that the Soviet gas vans mentioned in chapter 3.2.1. may have inspired some Soviet official to invent stories about German “gas vans,” I do not believe that the general populace in the Soviet territories temporarily occupied by the Germans had any knowledge about these Soviet vans. Hence I consider their existence not sufficient to explain why so many witnesses testified to their existence in German hands, all the more so since some of the witnesses had no connection to the Soviet territories to begin with.

## 5. Conclusions

There can be no doubt that the Germans of the later 19<sup>th</sup> and early 20<sup>th</sup> century were a special breed. Just imagine all the things they did: they invented the gasoline engine, the Diesel engine, the Wankel engine, the jet engine, and the rocket engine; by the end of WWII they had the first rockets, first jets, first helicopters, first stealth submarines, first plans for building space shuttles and stealth bombers; by that time they had also invented nerve gases, had discovered nuclear energy, developed coal gasification, invented artificial rubber, the video telephone, the amateur video camera, infrared-based night vision devices, tape recording, TV, live TV, color TV, cable TV, microwave ovens, discovered the link between smoking and lung cancer, built the first computer (Zuse, tube-based), and last but not least the electron microscope.

What can one expect from such a people when they turn their energy to murdering people *en masse*? Crude, hardly operable makeshift solutions?

Because this question is *not* rhetorical in nature, I hope that the reader will permit me to delve into the matter a little bit deeper. The question is, more accurately put, what options the Germans had and which one they would have chosen to commit mass murder. This might sound a little crazy, as it appears to be a contest in mass murder, but this thought experiment is necessary to realize the nature and quality of the claims made about the gas vans, among other things.

In his study of the alleged Auschwitz gas chambers, Germar Rudolf has discussed the various options available to the Auschwitz camp authorities (Rudolf 2011, pp. 226-229), while Fritz Berg has done something similar for the *Aktion Reinhard* camps (in Rudolf 2003, pp. 459-462), and in his study about Chełmno, Carlo Mattogno has marveled over the question why the Germans are said to have used CO, when they had at their disposal numerous other agents which were much more potent (Mattogno 2011a, toward the end of his chapter 2).

I will not argue here that carbon monoxide would not have been a good choice for the Germans – or anyone else intending to kill with a



toxic gas. Any other, more potent agent always has the severe drawback that it is also very dangerous for the perpetrator. But not CO, if a few safety rules are observed. In addition, CO can be generated easily and cheaply, is easily applied, and is easy to discard. Once released into the environment, it quickly dilutes down to harmless concentrations and is rapidly oxidized to innocuous CO<sub>2</sub>.

The question is: how would the Germans, ingenious engineers and chemists as they were back then, have constructed a “gas van”? I do not wish to go into details here, but will focus mainly on the source of carbon monoxide. The attentive reader might already guess what I am getting at: producer gas vehicles. Already after World War One this technique was developed in Germany, and during World War Two the Germans improved that technique to a high standard and produced hundreds of thousands of these devices.

Hence, if the Germans had used the Saurer trucks mentioned in the Gaubschat exchange as gas vans – or any other truck – they would have been equipped with wood gas generators, and this very gas – before(!) entering the engine – would have been used to kill the inmates locked up in the cargo box. I have prepared a drawing of such an operational hypothetical Saurer gas van; see Illustration 27 (p. 379).

Illustration 26 (p. 378), on the other hand, shows a draft of an impossible “gas van” as described in the pertinent literature using the exhaust gases of a Saurer Diesel engine, piped into the cargo box’s floor via a metal hose. The vehicle’s dimensions are based on the Gaubschat correspondence (cargo box height to length ratio 1.7:5.8). The problems with such a design are insurmountable. Such vans could simply not have served the function ascribed to them.

Today, after several decades of extended and exhaustive archival and forensic studies, we know with a probability bordering on certainty that there never were any stationary “gas chambers” for the mass murder of human beings.<sup>127</sup> Is the situation identical with regard to the “gas vans”? Back in 1994 Pierre Marais concluded in his tome that his studies did not yield any evidence for their existence. Although I have been able to scrutinize many more sources than were available to Marais, my own verdict is basically the same:

➤ There are still no material traces of these vehicles and no photos.

---

<sup>127</sup> For this see the various studies: Berg 2003; Crowell 2000/2011; Graf/Kues/Mattogno 2010; Mattogno/Graf 2005; Leuchter/Faurisson/Rudolf 2011; Mattogno 2004a&b, 2005a&b, 2010, 2011b; Rudolf 2011.

- The forensic findings about claimed gassing victims presented during communist show trials are not worth the paper they are written on.
- None of Marais's reasons to doubt the authenticity of the key documents alleged to prove the gas vans' existence have ever been addressed, let alone refuted, and I have found more such reason to suspect foul play.
- The few additional documents not known to Marais which I have analyzed here have increased the impression that such documents are either ambiguous (Activity Report by *Einsatzgruppe B*) or highly suspicious (the Turner letter).
- The contradictory and at times absurd nature of witness testimony, already demonstrated by Marais, has been revealed in an even more glaring light in this study.

All this does not prove that gas vans never existed. But then again, having no evidence for the existence of the Flying Spaghetti Monster doesn't refute its existence either. He who wants to believe will always do so. However, he who wants to have unequivocal evidence will not find it – for now.



## 6. Appendices

### Appendix 1: Images of Alleged “Gas Vans”

See my comments in chapter 2.1.

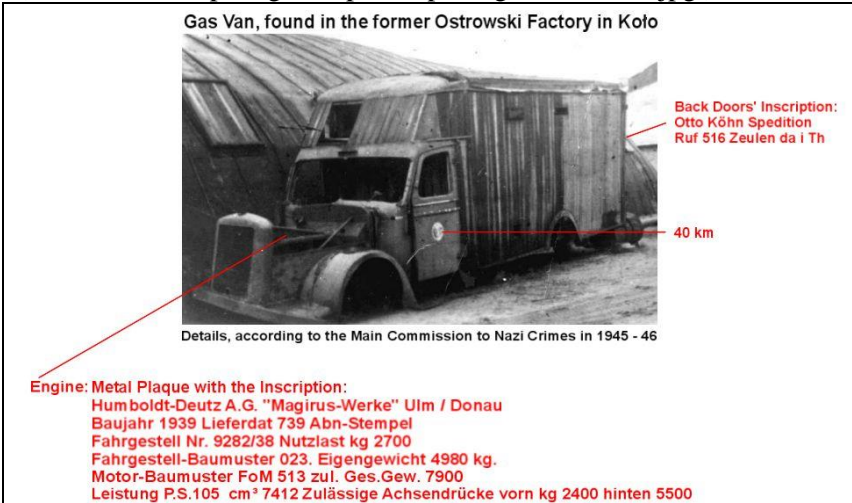

**Illustration 12:** Photo taken by a Polish investigation commission showing a derelict moving truck (acc. to Halbersztadt; <http://dss.ucsd.edu/~lزامosc/chelm00.htm>; also cropped at <http://collections.yadvashem.org/photosarchive/en-us/43921.html>). Deceptively mislabeled by Gerald Fleming as a “Gas van used to liquidate Jews at the Kulmhof (Chełmno) extermination camp and near Konitz” (1984, plate 7, after p. 92). In late 2010 the Internet encyclopedia Wikipedia had this photo posted on seven(!) entries with the false caption “Gas Van in Chełmno extermination camp” (Gas van; Einsatzgruppen; Chełmno extermination camp; Walter Rauff; Sajmište concentration camp; Wilhelm Rediess; August Becker).

---



**Illustration 13:** Same as before, different angle, but probably taken at a later time, since the hood has been removed and a hole appears in the area above the windscreen  
([www.deathcamps.org/occupation/pic/bigchelnovan.jpg](http://www.deathcamps.org/occupation/pic/bigchelnovan.jpg)).



**Illustration 14:** Same as before; details added as captions according to Halbersztadt (as above); the misleading headline has probably been added by [www.deathcamps.org](http://www.deathcamps.org)  
([www.deathcamps.org/gas\\_chambers/pic/bigkulumhof2.jpg](http://www.deathcamps.org/gas_chambers/pic/bigkulumhof2.jpg);  
<http://collections.yadvashem.org/photosarchive/en-us/89591.html>).

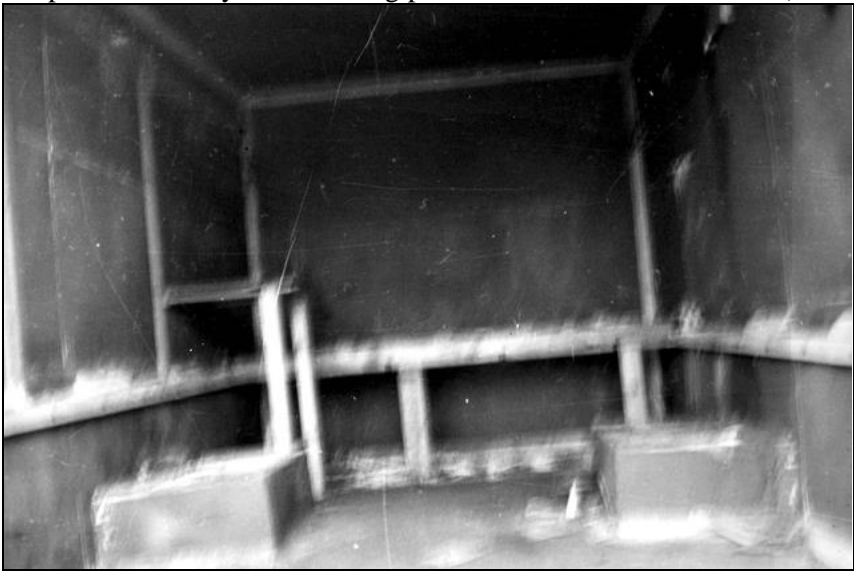

Photo: Yad Vashem

**Illustration 15:** Same as before, rear view

([www.deathcamps.org/gas\\_chambers/pic/bigkulmhof4.jpg](http://www.deathcamps.org/gas_chambers/pic/bigkulmhof4.jpg);

<http://collections.yadvashem.org/photosarchive/en-us/54160.html>).



**Illustration 16:** Same as before, interior; a low quality photo of the

moving truck's cargo box. Yad Vashem, archival reference 1427/84

(<http://collections.yadvashem.org/photosarchive/en-us/28025.html>)

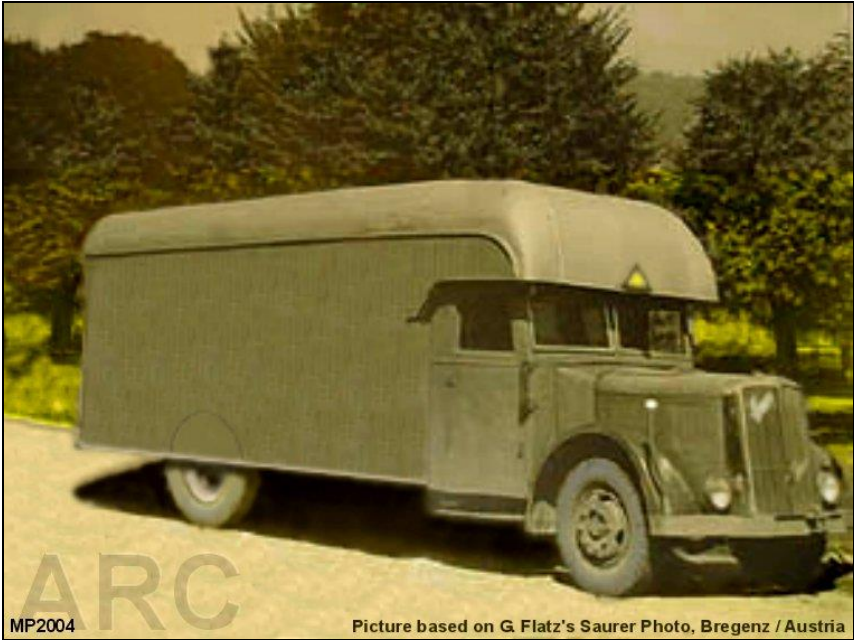

**Illustration 17:** Gas van artwork by [www.deathcamp.org](http://www.deathcamp.org): A photoshopped image of a Saurer truck “based on G. Flatz’s Saurer Photo” ([www.deathcamps.org/gas\\_chambers/pic/bigkulmhof3.jpg](http://www.deathcamps.org/gas_chambers/pic/bigkulmhof3.jpg)).



**Illustration 18:** Gas van artwork by [www.deathcamp.org](http://www.deathcamp.org): A drawing of a hypothetical “gas trailer” drawn by a tractor ([http://www.deathcamps.org/gas\\_chambers/pic/bigtrailer.jpg](http://www.deathcamps.org/gas_chambers/pic/bigtrailer.jpg)).

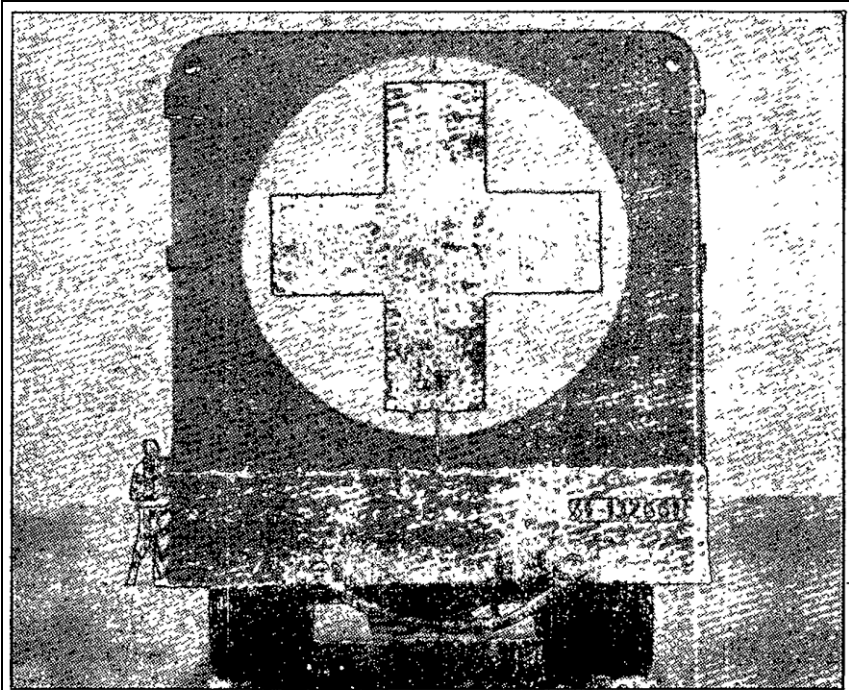

SS-Gaswagen: „Die Leute haben nicht geschrien“

**Illustration 19:** A “gas van” according to *Der Spiegel* (1966; same image used in *Der Spiegel* 1963, 1967a).



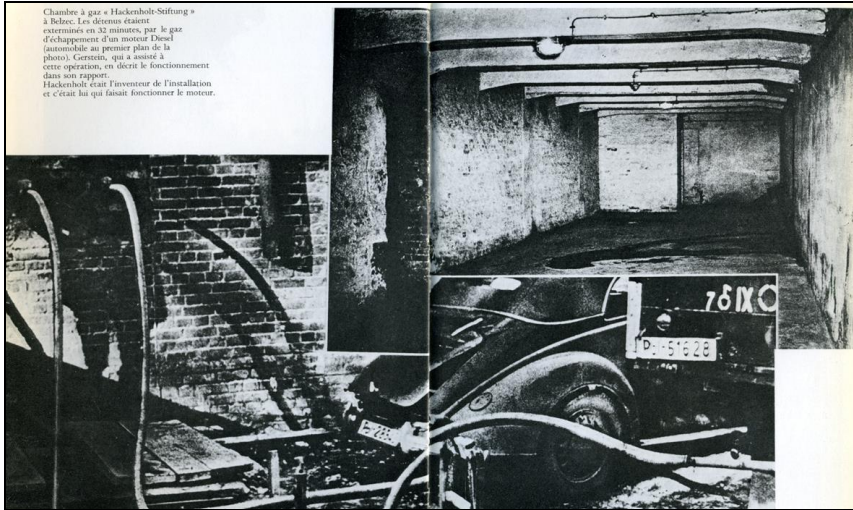

**Illustration 20:** A “gas van” according to Alain Decaux. Alain Decaux has taken this photo composition from Saul Friedländer’s book *Kurt Gerstein et l’ambiguïté du bien*, whose version is shown here (1967, between pages 16 and 17). It bears the following fraudulent caption, misleading the reader to believe that this is what he sees:

*“Gas chamber ‘foundation Hackenholt’ at Belzec. The inmates were exterminated within 32 minutes by means of exhaust gas of a Diesel engine (car in the foreground of the photo). Gerstein, who assisted in this operation, has described its functioning in his report. Hackenholt was the inventor of the installation, and it was he who made the engine operate.”*

As a matter of fact, the room in the upper right is the morgue of the former crematorium in the Auschwitz main camp, which is today presented to tourists as a homicidal “gas chamber” (see Mattogno 2005a, p. 130). The cars shown are of an unknown origin and have nothing to do with what Friedländer claims. Apart from which, Gerstein had claimed that a separate Diesel engine fed the gas into the chamber, not a truck engine.



Als ich einige Tage später nach Stalino und Gorlowka kam, beklagten sich die Fahrer der Wagen über denselben Schaden. Nach Rücksprache mit den Kommandeuren dieser Kommandos be- gab ich mich nochmals nach Mariupol um weitere Mancheten auch für diese Wagen anfertigen zu lassen. Auf Vereinbarung wer- den für jeden dieser Wagen zwei Mancheten gegossen, sechs Mancheten bleiben als Reserve in Mariupol für die Gruppe D und 6 Mancheten werden an H-Untersturmführer E r n s t für die Wagen der Gruppe C nach Kiew gesandt. Für die Gruppen B und A könnten die Mancheten von Berlin aus beschafft werden, weil der Transport von Mariupol nach dem Norden zu umständlich ist und zu lange dauern würde. Kleineren Schäden an den Wagen werden von Fachleuten der Kommandos bzw. der Gruppen in eigen- ner Werkstatt ausgeführt.

Durch das unebene Gelände und die kaum zu beschreiben- den Wege- und Strassenverhältnisse lockern sich im Laufe der Zeit die Abdichtungen und Nietstellen. Ich wurde gefragt, ob in solchen Fällen der Wagen zur Reparatur nach Berlin überführt werden soll. Eine Überführung nach Berlin käme viel zu teuer und würde zu viel Betriebsstoff erfordern. Um diese Ausgaben zu sparen gab ich die Anordnung, kleinere undichte Stellen selbst zu lüten und wenn das nicht mehr zu machen wäre, sofort Berlin durch Funk zu benachrichtigen, dass der Wagen Pol.Nr. .... ausgefallen sei. Ausserdem ordnete ich an, bei den Ver- gasungen alle Männer vom Wagen möglichst fernzuhalten, damit sie durch evtl. ausströmende Gase gesundheitlich nicht ge- schädigt werden. Bei dieser Gelegenheit möchte ich auf folgen- des aufmerksam machen: Verschiedene Kommandos lassen nach der Vergasung durch die eigenen Männer ausladen. Die Kommandeure der betreffenden S.K. habe ich darauf aufmerksam gemacht, welch ungeheure seelische und gesundheitliche Schäden diese Arbeit auf die Männer, wenn auch nicht sofort, so doch später haben kann. Die Männer beklagten sich bei mir über Kopfschmer- zen, die nach jeder Ausladung auftreten. Trotzdem will man von dieser Anordnung nicht abgehen, weil man befürchtet, daß die für die Arbeit herangezogenen Häftlinge einen günstigen Augenblick zur Flucht benutzen könnten. Um die Männer vor diesen Schäden zu bewahren bitte ich, dementsprechende Anordnun- gen herauszugeben.

Die Vergasung wird durchweg nicht richtig vorgenommen. Um die Aktion möglichst schnell zu beenden, geben die Fahrer

A 090027

- 3 -

durchweg Vollgas. Durch diese Massnahme erleiden die zu Exekutierenden den Erstickungstod und nicht wie vorgesehen, den Einschlafertod. Meine Anleitungen haben nun ergeben, dass bei richtiger Einstellung der Hebel der Tod schneller eintritt und die Häftlinge friedlich einschlafen. Verzerrte Gesichter und Ausscheidungen wie sie seither gesehen wurden, konnten nicht mehr bemerkt werden.

Im Laufe des heutigen Tages erfolgt meine Weiterreise nach der Gruppe B, wo mich weitere Nachrichten erreichen können.

*H. Becker*

Untersturmführer.

A 090028

Letter of authentication. Source as Version A

OFFICE OF CHIEF OF COUNSEL FOR WAR CRIMES  
EVIDENCE DIVISION

Date: 19 July 1948

I certify that Document Number 501-PS was introduced into evidence as Exhibit Number USA-288 in the Trial by the International Tribunal of Hermann GOERING, et al, which commenced on 20 November 1945, and that the attached photostat is a true and correct copy of the original.

*Nuremberg, 19 July 1948*  
*Fred Dieburg*  
FRED DIEBURG  
Chief, Document Control Branch



Version B

Source as Version A

15-10

Feldpostnummer 32 704 Kiew, den 16.5.42

B.N. 40/42 GEHEIME REICHSSACHE

RIG 778

An  
 SS-Obersturmbannführer Rauff *Pol 1/5 pers. wtl. Pradel u. R. ly R.*  
 in Berlin  
 Prinz-Albrecht-Str. 8

Die Überholung der Wagen bei der Gruppe D und C ist beendet. Während die Wagen der ersten Serie auch bei nicht allzu schlechter Wetterlage eingesetzt werden können, liegen die Wagen der zweiten Serie (Saurel) bei Regenwetter vollkommen fest. Wenn es z. B. nur eine halbe Stunde geregnet hat, kann der Wagen nicht eingesetzt werden, weil er glatt wegrutscht. Benutzbar ist er nur bei ganz trockenem Wetter. Es tritt nur die Frage auf, ob man den Wagen nur an Orte der Exekution im Stand benutzen kann. Erstens muss der Wagen an diesen Ort gebracht werden, was nur bei guter Wetterlage möglich ist. Der Ort der Exekution befindet sich aber meistens 10-15 km abseits der Verkehrswege und ist durch seine Lage schon schwer zugänglich, bei feuchten oder nassen Wetter überhaupt nicht. Fahrt oder führt man die zu Exekutierenden an diesen Ort, so merken sie sofort was los ist und werden unruhig, was nach Möglichkeit vermieden werden soll. Es bleibt nur der eine Weg übrig, sie an Sammelorte einzuladen und dann hinauszufahren.

Die Wagen der Gruppe D habe ich als Wohnwagen tauschen lassen, indem ich an den kleinen Wagen auf jeder Seite einen an der grosse Wagen auf jeder Seite zwei Fensterleiste anbringen liess, wie man sie oft an den Bauernhäusern auf dem Lande sieht. Die Wagen waren so bekannt geworden, dass nicht nur die Behörden sondern auch die Zivilbevölkerung den Wagen als "Todeswagen" bezeichneten, sobald eines dieser Fahrzeuge auftauchte. Nach meiner Meinung kann er auch getarnt nicht auf die Dauer verheimlicht werden.

Der Saurelwagen, den ich von Simferopol nach Taganrog überführte, hatte unterwegs Bremschaden. Beim S.K. in Mariupol wurde festgestellt, dass die Manchette der kombinierte Öl-Luftdruckbremse an mehreren Stellen gebrochen war. Durch Überredung und Bestechung beim H.K.P. gelang es eine Porzellan drehen zu lassen, nach der zwei Manchetten gegossen wurden. Als ich einige Tage später nach Stalino und Gorlowka kam, beklagten sich die Fahrer der Wagen über denselben Schaden. Nach Rücksprache mit den Kommandanten dieser Kommandos begab ich mich nochmals nach Mariupol um weitere Manchetten auch für diese Wagen anfertigen zu lassen. Auf Vereinbarung werden für diesen Wagen zwei Manchetten gegossen, sechs Manchetten bleiben als Reserve in Mariupol für die Gruppe D und 6 Manchetten werden an SS-Untersturmführer E R N S T für die Wagen der Gruppe C nach Kiew gesandt. Für die Gruppen B und A könnten die Manchetten von Berlin aus beschafft werden, weil der Transport von Mariupol nach dem Norden zu unschwerlich ist und zu lange dauern würde. Kleinere Schäden an den Wagen werden von Fachleuten der Kommandos bzw. der Gruppen in eigener Werkstatt ausgeführt.

Durch das unebene Gelände und die kaum zu beschreibenden Wege- und Strassenverhältnisse lockern sich im Laufe der Zeit die Abdichtungen und Nietstellen. Ich wurde gefragt, ob in solchen Fällen der Wagen zur Reparatur nach Berlin überführt werden soll.

H 200 1271/42  
 No. 1000/42  
 4. 04  
 11

Eine Überführung nach Berlin käme viel zu teuer und würde zu viel Betriebsstoff erfordern. Um diese Ausgaben zu sparen gabe ich die Anordnung, kleinere unlichte Stellen selbst zu löten und wenn das nicht mehr zu machen wäre, sofort Berlin durch Funk zu benachrichtigen, dass der Wagen Pol. Nr. .... ausgefallen sei. Außerdem ordnete ich an, bei den Vergasungen allen Mannern von Wagen möglichst fernzuhalten, damit sie durch evtl. ausströmende Gase gesundheitlich nicht geschädigt werden. Bei dieser Gelegenheit möchte ich auf folgendes aufmerksam machen: Verschiedene Kommandos lassen nach der Vergasung durch die eigenen Mannern ausladen. Die Kommandeure der betreffenden S.K. habe ich darauf aufmerksam gemacht, welch ungeheure seelische und gesundheitlich Schaden diese Arbeit auf die Mannern, wenn auch nicht sofort, so doch später haben kann. Die Mannern beklagten sich bei mir über Kopfschmerzen, die nach jeder Ausladung auftraten. Trotz-dem will man von dieser Anordnung nicht abgehen, weil man befürchtet, daß die für die Arbeit herangezogenen Häftlinge einen günstigen Augenblick zur Flucht benutzen könnten. Um die Mannern vor diesen Schaden zu bewahren bitte ich, dementsprechende Anordnungen herauszugeben.

Die Vergasung wird durchweg nicht richtig vorgenommen. Um die Aktion möglichst schnell zu beenden, geben die Fahrer durchweg Vollgas. Durch diese Massnahme erleiden die zu Exekutierenden den Erstickungstod und nicht wie vorgesehen, den Einschleiferungstod. Meins Anleitungen haben nun ergeben, dass bei richtiger Einstellung der Hebel der Tod schneller eintritt und die Häftlinge friedlich einschlafen, verzerrte Gesichter und Ausscheidungen wie sie seither gesehn wurden, konnten nicht mehr bemerkt werden.

Im Laufe des heutigen Tages erfolgt meine Weiterreise nach der Gruppe B, wo mich weitere Nachrichten erreichen können.

(Sgd)

Becker

}}-Untersturmführer

Version C

Reproduction of a photograph taken of an exhibit in a showcase at the U.S. National Archives, showing page one of a positive copy of the Becker document, consistent with the first page of the negative photostat of version A.

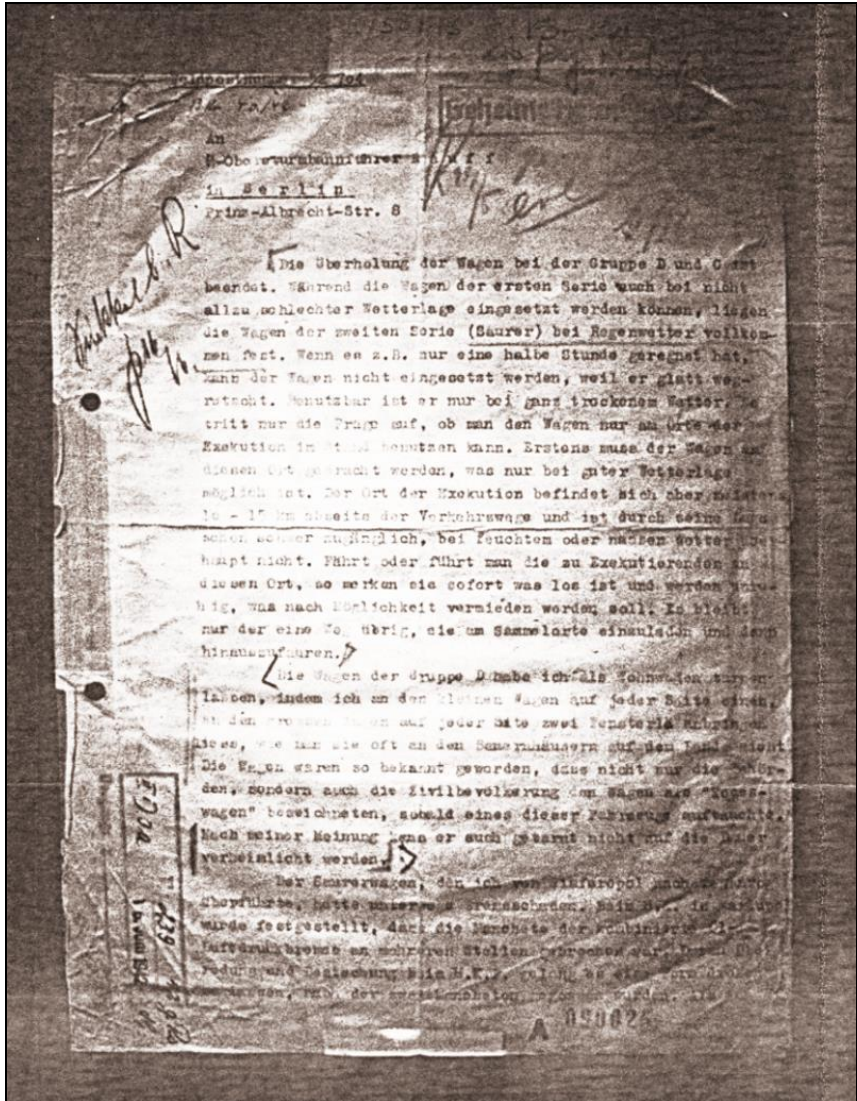



Version D

Photostat authenticated by Walther Rauff at the left margin; part of Nuremberg documents PS-2348. Source: U.S. National Archives.

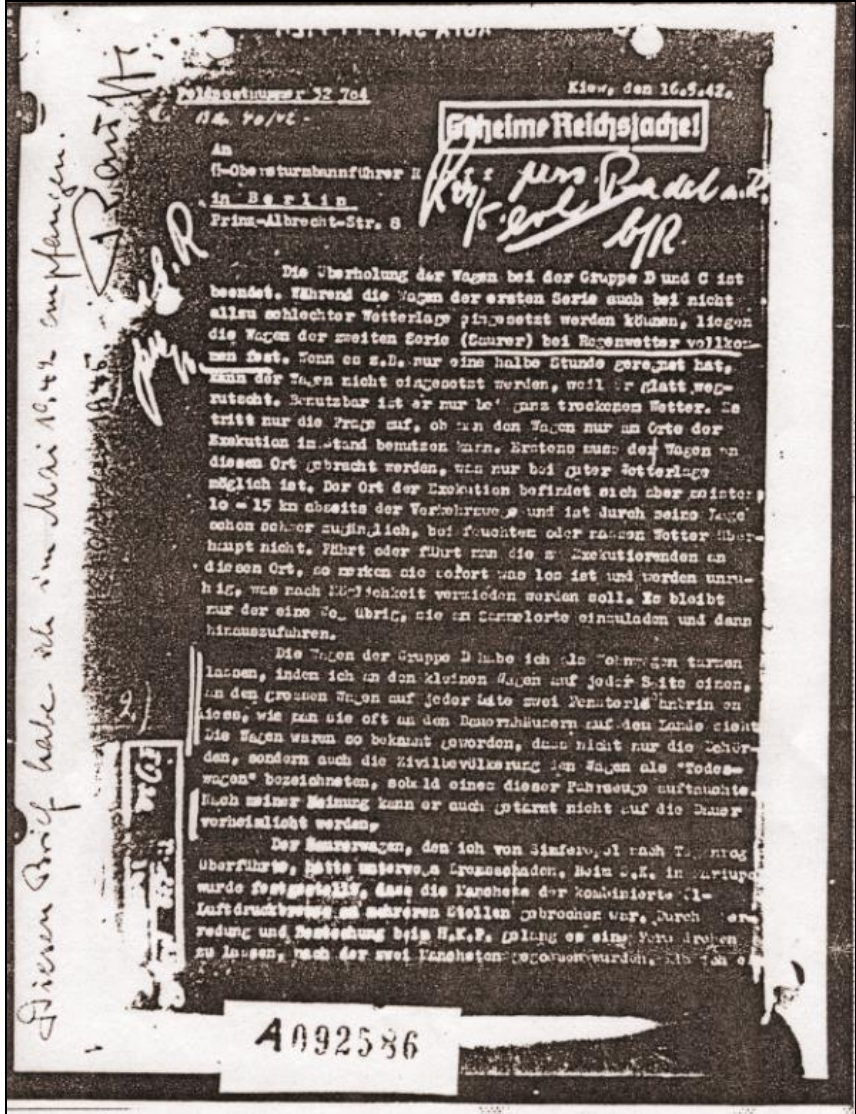

Appendix 3: The Telegrams of Document 501-PS

Source: U.S. National Archives, rec. no HLSTL\_NUR\_02459004 to 7 (for the Becker document see Appendix 2)

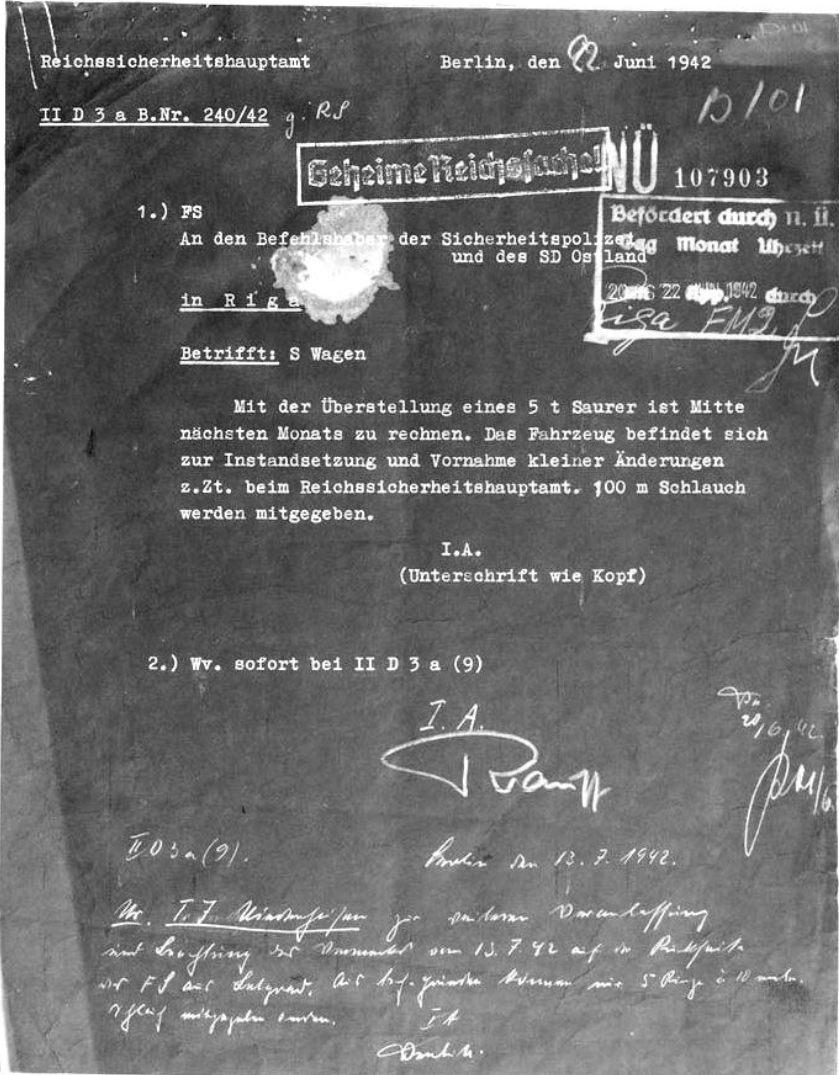

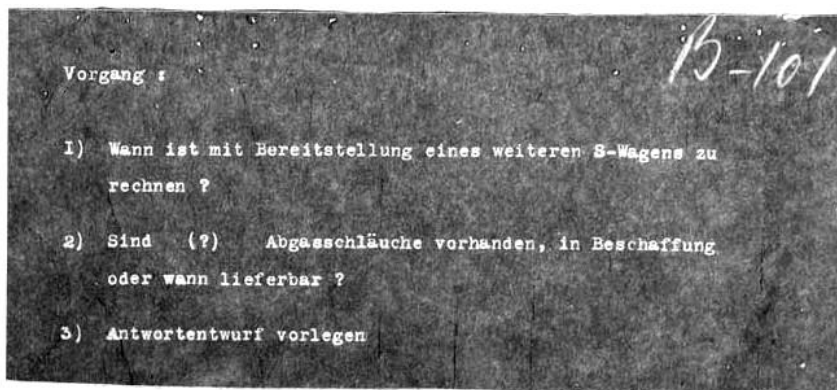

---

22 June 1942 draft for telegram from RSHA, Berlin,  
front (previous page) and back

REICHSSICHERHEITSHAUPTAMT  
Nachrichten-Uebermittlung

*II D 3 - Major Pradel*

N. U. Nr. 152452

RIGA 7082 - 15.6.42 -1855 - BE. - - *Wiederholen*  
AN DAS RSHA. - ROEM. 2 D 3 A - B E R L I N. -  
GEHEIME R E I C H S S A C H E. - - -  
BETRIFFT S. - WAGEN. -  
- BEIM KOMMANDEUR DER SIPO U. D. SD. WEISSRUTHENIEN  
TRIFFT WOCHENTLICH EIN JUDENTTRANSPORT EIN, DER EINER  
SONDERBEHANDLUNG ZU UNTERZIEHEN IST.  
DIE 3 DORT VORHANDENEN S- WAGEN REICHEN FUER DIESEN  
ZWECK NICHT AUS! ICH BITTE UM ZUWEISUNG EINES WEITEREN  
S- WAGEN ( 5 TONNER). GLEICHZEITIG WIRD GEBETEN, FUER  
DIE VORHANDENEN 3 S- WAGEN ( 2 DIAMOND, 1 SAURER) NOCH  
20 ABGASSCHLAUCHE MITZUSENDEN, DA DIE VORHANDENEN  
BEREITS UNDICHT SIND. = =

= DER BEF. DER SIPO U. D. SD. OSTLAND  
ROEM. 1 T - 126/42 GRS.-  
A. GEZ. TRUBHESS. HSTUF! . - =

.....

+ BELGRAD- MR. 3116 9.6.42 0950 = SOM = = = *Nach Rückkehr*  
AN DAS R.S.H.A. AMT. ROEM 2 D 3 KL. A- Z. HD. V. *ist wieder*  
MAJOR P R A D L - B E R L I N. = = = *zustand setzen*  
BETRIFFT: SPEZIALWAGEN- S A U R E R. = = *Feststellung melden*  
VORGANG: O H N E. = =

DIE KRAFTFAHRER SS- SCHAUF. G O T T E - U. M E Y E R  
HABEN DEN SONDERAUFTRAG DURCHGEFUHRT. SODASS DIE GE-  
NANNTEN MIT DEM OBENANGEBENEN FAHRZEUG ZURUECKBEORDERT  
WERDEN KOENNEN. INFOLGE ACHSRISSES DER HINTEREN ACHSHAUPT  
KANN EINE UEBERFUHRUNG PER ACHSE NICHT ERFOLGEN. = =  
ICH HABE DAHER ANGEODNET, DASS DAS FAHRZEUG VERLADEN MIT  
DER EISENBAHN NACH BERLIN UEBERFUHRT WIRD. VORAUSSICH-  
TIGES EINTREFFEN \* ZWISCHEN DEM 11. U9 12 6. 42 DIE  
KRAFTFAHRER G O T T E U. M E Y E R BEGLEITEN DES FAHRZEUG. = =

DER BEFH. D. SIPO u. D. SD - BELGRAD- ROEM 1 - BER.  
3985/42 42  
GEZ. DR. SCHAEFER- SS- OBERSTUBAF. = =

A 090031

Summary of telegrams of 9 & 15 June 1942 (version A)

**090032 Reichsfürsicherheitshauptamt**  
Nachrichten-Übermittlung 101-15

Empfänger				Rang für Eingangsprotokoll				Absender			
Zeit	Tag	Monat	Jahr					Zeit	Tag	Monat	Jahr
10 00	15 JUN	1942		<i>II 13<sup>a</sup> Maj. Pradeel</i>							
<i>Riga 22</i>								<i>[Handwritten signatures]</i>			
D.-O. Nr. <i>102452</i>				Telegramm — Funkpruch — Fernschreiben Fernpruch							

**RIGA 7082 - 15.6.42 -1855 - BE. - -**  
**AN DAS RSHA. - ROEM. 2 D 3 A - B E R L I N. -**  
**GEHEIME R E I C H S S A C H E. - - -**  
**BETRIFFT S.-WAGEN. -**  
 - BEIM KOMMANDEUR DER SIPO U. D. SD. WEISSRUHIEN -  
 TRIFFT WOECHENTLICH EIN JUDENTRANSPORT EIN, DER EINER  
 SONDERBEHANDLUNG ZU UNTERZIEHEN IST. -  
 DIE 3 DORT VORHANDENEN S- WAGEN REICHEN FUER DIESEN  
 ZWECK NICHT AUS. ICH BITTE UM ZUWEISUNG EINES WEITEREN  
 S- WAGEN( 5 TONNER). GLEICHZEITIG WIRD GEBETEN, FUER  
 DIE VORHANDENEN 3 S- WAGEN( 2 DAIMOND, 1 SAURER) NOCH  
 20 ABGASSCHLAEUCHE MITZUSENDEN, DA DIE VORHANDENEN  
 BEREITS UNDICHT SIND. =

Referenz

DER BEF. DER SIPO U. D. SD. OSTLAND

*50* ja. 11-240 18. Juni 1942

DEM. 1 T - 126/42 GRS. -  
A. GEZ.: TRUEHESS. HSTUF. -1

**Darlegung:**

- 1) Mann ist mit Befehlsgewalt nicht mit dem S-Wagen zu infizieren
- 2) Mann Rufnummer abgeben, Abfänger mit Befehlsgewalt oder wenn dies nicht geht
- 3) Aufmerksamkeitsaufmerksamkeit nicht sein

*Pradeel*

D.O. Nr. 120. 501-PS

Telegram of 15 June 1942 from Riga, version B

*Nach Rückkehr  
wieder in den  
Instandsetzen.*

**Reichssicherheitshauptamt**  
Nachrichten-Übermittlung

Zeit		Empfangen		Name Nr. Eingangstempel		Gesendet	
Tag	Monat	Tag	Monat			Tag	Monat
03	JUN 1942	03	JUN 1942	Nr. 964/42			
				10. Juni 1942			
Vorgang				<i>[Signature]</i>		Feststellung melden	
N.-O. Nr. 144702						Telegramm — Funkpruch — Fernschreiben Fernspruch	

+ BELGRAD- NR. 3116 9.6.42 0950 == SOM ==

AN DAS R. S. H. A. AMT. ROEM 2 D 3 KL. A- Z. HD. V.

MAJOR PRADL - BERLIN .---

BETRIFFT: SPEZIALWAGEN- SAURER .--

VORGANG: O H N E.---

DIE KRAFTFAHRER SS- SCHARF. GOETZ - U. A EYER  
HABEN DEN SONDERAUFTRAG DURCHGEFUEHRT, SODASS DIE  
GENANNTEN MIT DEM OBENANGEgebenEN FAHRZEUG  
ZURUECKBEORDERT WERDEN KOENEN. INFOLGE ACHSRISSES  
DER HINTEREN ACHSHAELFTE KANN EINE UEBEFUEHRUNG PER  
ACHS WIESEN .---

Reifend

ICH HABE DAHER ANGEODNET, DASS DAS FAHRZEUG VERLADEN  
MIT DER EISENBAHN NACH BERLIN UEBERFUEHRT WIRD.  
VORAUSSICHLICHES EINTREFFEN ZWISCHEN DEM 11. U9 12 6.42

DIE KRAFTFAHRER GOETZ U. MEYER BEGLEITEN DAS FAHRZEUG.--

DER BEFH. D. SIPO U. D. SD- BELGRAD- ROEM 1 - BNR.

3985/42 42

GEZ. DR. SCHAEFER- SS- OBERSTUBAF- .+

6.St. Nr. 120. *501-PS* A 090033

Telegram of 9 June 1942 from Belgrade, version B



FD 3 a (2) Berlin, den 11. 6. 42

W.  
 U.S. a. Pr. L. Lohschel  
 zur weiteren Veranlassung in. sofortigen  
 Inangriffnahme der Einstandssetzung.  
 Von dem Eintreffen der Hfg. Bitte  
 ich mich in Kenntnis zu setzen  
 f. d.  
 Just

FD 3 a (9)  
 Danneub  
 Berlin, den 16. 6. 42.

Der Befehl ist am 16. 6. 42 gegen 13.00 Uhr  
 ausgeführt, das gleiche Prinzipium wird die Aufstellung  
 sofort in Angriff genommen  
 FA  
 Dank

FD 3 a 9 Berlin, den 13. 7. 42.

1. Personal: Die S-Dagen Pol 71463 ist fertig gestellt.  
~~2. 5 ist mit dem Namen auf Lager - Klausur: 10. 10.~~

2). Die Typenkomplettierung 7. 2. 1942 ist fertig gestellt  
 im Kenntnisnahme und weiteren Bearbeitung zugeführt.  
 IA  
 Schmidt

090031

Back of Belgrade telegram of 9 June 1942 with handwritten notes

## Appendix 4: Dossier R 58/871 f°1, BAK

This file contains altogether 22 sheets. The first 21, which are of significance, are reproduced here in chronological order; the 22nd merely contains signatures, initials and illegible handwritten lines in German, which is not relevant for this study.

Considering the decisive role the note of 5 June 1942 has in this context – it is one of the two main pillars of the thesis of the existence of “gas vans,” the second being the Becker document – it is appropriate to also reproduce the other three parts of this file which obviously form the basis of this note and which also give us technical information about these unknown special vehicles used by the Germans during the Second World War.

<u>DOCUMENT</u>	<u>PAGE</u>
Letter of 26 March [194]2 .....	296
Translation & Remarks .....	297
Memo of 27 April 1942.....	296
Translation & Remarks .....	299
Letter of 30 April 1942.....	312
Translation & Remarks .....	314
Letter of 14 May 1942.....	316
Translation.....	317
Memo of 5 June 1942 (Just document) .....	316
Memo and letter of 23 June 1942 .....	323
Translation & Remarks .....	326
Juxtaposition of Two Documents.....	328
Letter of 18 September 1942.....	330
Translation.....	331
Letter of 24 September 1942.....	331
Translation.....	333

With the exception of the note of 5 June 1942 (and maybe the one of 23 June 1942), the content of this file and in particular the correspondence with the Gaubschat company does not contain unequivocal evidence giving rise to the suspicion that this is about murdering people.



Letter of 26 March [194]2

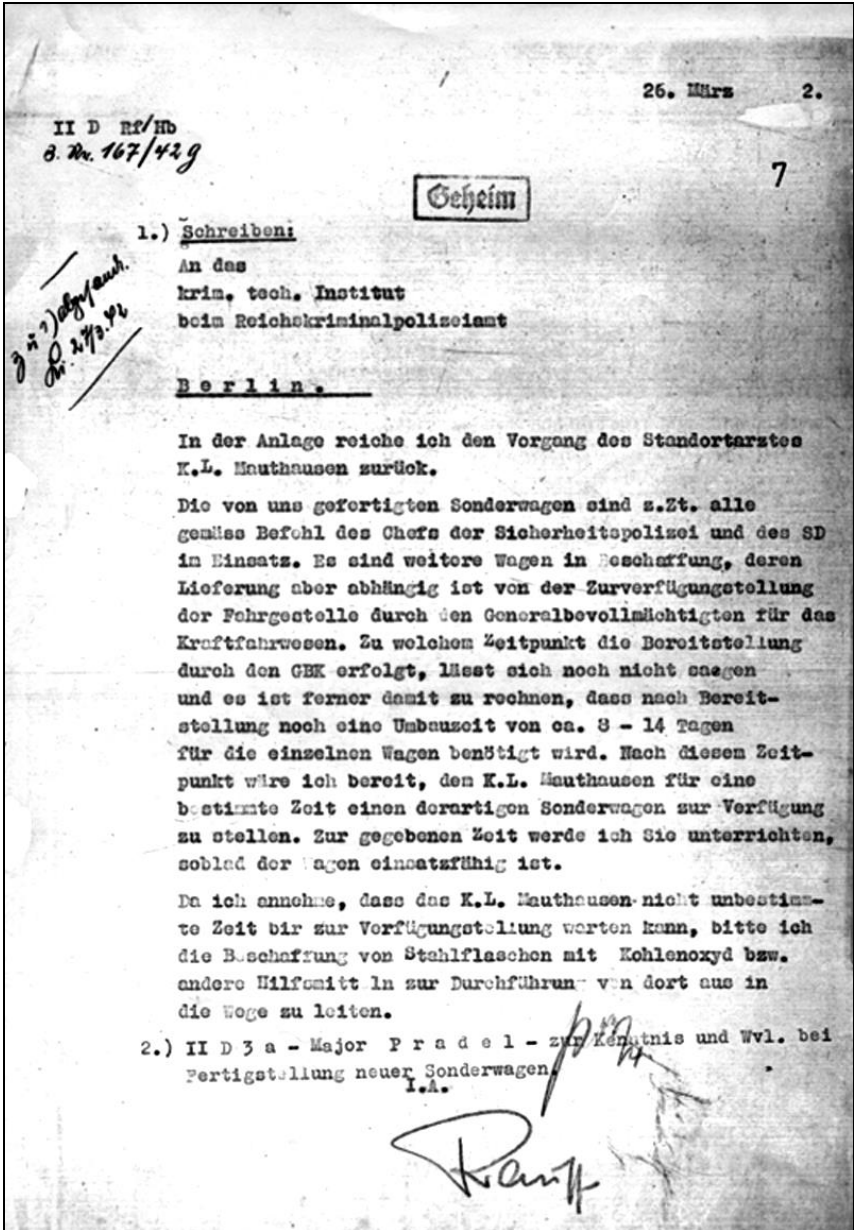

## Translation &amp; Remarks

26 March 2.

II D Rf/HB

*B. Nr. 167/42g*1.) Letter:

To the  
Institute for Crim. Tech.  
At the Imperial Police Office for Investigations

B e r l i n.

Attached I return the file of the garrison physician concentration camp Mauthausen.

The special vehicles manufactured by us are currently all in use according to the order of the head of the Security Police and the SD. More vehicles are on order, whose delivery, however, depend on the availability of the chassis by the Plenipotentiary [GBK] of motor vehicles. It is not yet known when the allocation will be made by the GBK, and it has to be reckoned that after the allocation an additional time for conversion of ca. 8 to 14 days will be needed for the individual vehicles. After this point in time I would be prepared to place such a special vehicle at the disposal of the concentration camp Mauthausen for a certain period of time. At a given time I will apprise you, as soon as the vehicle can be deployed.

Since I assume that the concentration camp Mauthausen cannot wait for an undetermined amount of time for the allocation, I ask to initiate from there the acquisition of steel bottles with carbon oxide or other auxiliary agents for the implementation.

## 2.) II D 3 A – Major P r a d e l – for information and resubmission on completion of new special vehicles.

P.P.

(signed Rauff)

---

REMARKS: Formally seen, almost everything about this letter is wrong:

- a) The name of the sending authority (RSHA) is not given.
- b) The name of the sending office is incomplete: Instead of “II D 3,” it only states “II D.”

- c) Giving initials of the author (Rf) and of the secretary (Hb) was not practiced on any of the other RSHA letters in this file.
- d) The letter's serial no. "167/42g" is handwritten, not typed.
- e) No location (Berlin) is given
- f) The year is only typed as "2" instead of "1942"
- g) The paragraph starting with "2.)" was typed (squeezed in over the "I.A." line) after the paper had been removed from the machine, resulting in it being shifted and slightly rotated.
- h) Since it does not belong to the other documents of this file R 58/871 f°1, somebody must have put it there on purpose.
- i) Friedrich Pradel was not a major but rather an *SS-Hauptsturmführer* (equivalent to a captain).

I leave it up to the reader to decide whether that has any relevance.

The request allegedly came from the Mauthausen garrison physician. Considering that the Saurer special vehicles with their Diesel engines and low cargo boxes could not have served as mobile homicidal gas chambers, it would be interesting to know what the original request was for – if it ever existed.

Using "steel bottles with carbon [mon]oxide or other means" instead of these non-homicidal special vehicles is a strong indicator that the author forced a link between two items which cannot, in reality, have existed.

Assuming for the sake of the argument that the Mauthausen camp authorities really wanted to urgently murder people with carbon monoxide, any wood gas generator in their motor pool would have done the trick. Why request some rare, secret device from an Institute in Berlin? How could they have known about this secret device in the first place? And why did Rauff not complain that his State Secret was being banded about by just about anyone?

I posit that this document was created for the Nuremberg trial in order to get some documentary "corroboration" for the – obviously false – gas van claims made by Hans Maršálek (see chapter 3.5.7.).

Memo of 27 April 1942

Reichssicherheitshauptamt  
II D 3 a (9) Nr. 668/42-121.

b-12-17  
 Berlin, den 27. April 1942.

8

24.45

1.) REG.: Unter B.Nr. 1737/41, Hinweis eintragen.

2.) Vermerk:

Betr.: Schnellentladevorrichtung für die Sonderfahrzeuge.

Die Aufbauten der Sonderfahrzeuge haben eine Länge von 5800 mm und eine Höhe von 1700 mm. Das Eigengewicht der Aufbauten beträgt je 1600 kg, während das Ladegewicht 4500 kg ist.

Die Entladung soll schnell und möglichst selbsttätig erfolgen. Um dieses zu erreichen, ist der Aufbau oder ein zweiter Boden kippbar zu machen. Die Entladung kann auch durch einen ausfahrbaren Rost geschehen.

Nachstehende Entlademöglichkeiten sind auf ihre Zweckmäßigkeit hin zu prüfen.

a) Kippvorrichtung des Kastenaufbaues.

Zur Entladung ist eine Schrägstellung des Aufbaues von 30 - 35 ° erforderlich. Zum Heben des Gesamtgewichtes (1600 + 4500 kg) wird ein hydraulische Kipper benötigt, der 5 - 7 to drückt. Dieser hat eine Bauhöhe von 650 mm und einen Hub von 900 mm.

Die Anbringung des Kippers ist aus folgenden Gründen als unzweckmäßig zu betrachten:

Der Boden des Aufbaues muß verstärkt und mit einem Kipperrahmen versehen werden. (Nutzlastverlust)

Um Bauhöhe einzusparen, wären zweckmäßiger Zwillingskipper an den Chassisträgern anzubringen. Solche Kipper sind z.Zt. nicht erhältlich. Der o.g. hydraulische Einstempelkipper ist an einer verstärkten Traverse so hoch anzubringen, daß er nicht mit

dem

dem schwingenden Kardanrohr in Berührung kommt. Durch diese Anbringung und durch die Einfügung des Kipprahmens wird der Aufbau um mindestens 200 mm gehoben. Eine Höherstellung des Fahrzeugaufbaues ist aber unzulässig, weil damit das Eisenbahnladeprofil überschritten wird; es sei denn, man verkleinert den Innenraum. Der Innenraum verliert aber schon durch die Verstärkung des Bodens etwa 150 mm an lichter Höhe.

Die Lieferzeit für die Einstempelkipper ist  $\frac{1}{2}$  bis 1 Jahr.

Für die konstruktive Ausführung, die starke Abweichungen von der schon früher festgelegten Konstruktion aufweisen, stehen der Fa. Gaubschat z.Zt. keine Kräfte zur Verfügung.

Die Ausführung der Kippvorrichtung verzögert die Fertigstellung der Fahrzeuge um weitere sechs Wochen.

An Nutzlastgewicht verliert jedes Fahrzeug ca. 400 kg.

Der Mehrpreis beträgt bei jedem Fahrzeug RM 1000.-- bis 1200.--.

#### b) Kippbarmachung des Bodenrostes.

Der Rost (zweiter Boden) muß für eine Belastung von  $4 \frac{1}{2}$  to besonders stark gebaut sein. Damit wird der Aufbau 150 mm an Innenhöhe verlieren. Bei Fertigung eines durchgehenden Rostes sind auch die vorstehenden Radkästen zu überdecken. Dies bedingt einen weiteren Verlust an Innenhöhe.

Ferner wird der durch den Boden eingeführte Kipper in Bezug auf die Abdichtung der Einführungsstelle Schwierigkeiten bereiten. Es ist zu beachten, daß der Kipperstempel nicht gerade hebt. Er muß beim Heben

des

- 2 -

9

des zweiten Bodens mitschwenken können.

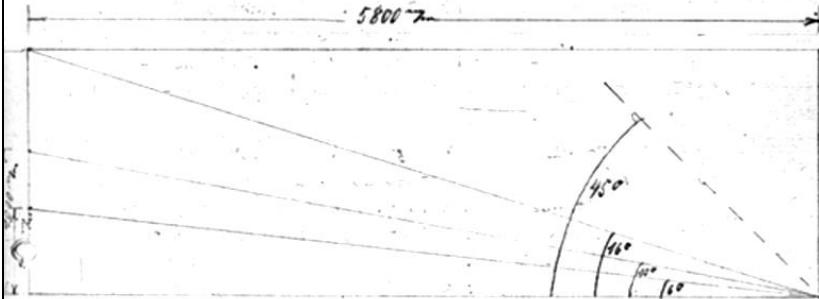

Weiter ist das Abrutschen des Ladegutes ein Problem. Für ein fließendes Rutschen wird eine Schrägstellung des Bodens von  $30^\circ$  bis  $35^\circ$  benötigt. Die Skizze veranschaulicht, daß selbst dann, wenn der Boden am losen Ende bis unter das Wagendach angehoben wird, immer nur eine Schrägstellung von  $16^\circ$  erreicht wird. Praktisch ist dieser Kippgrad nicht zu erreichen, weil am oberen Ende der Ladefläche ein Einpressen der Ladelast erfolgen würde. Die größte Hubhöhe, an der Kopfwand gemessen, dürfte 1000 mm betragen. Bei dieser Höhe ist der Steigungswinkel des Bodens nur  $10^\circ$ .

Ferner sind Nutzlast- und Zeitverlust (für Anfertigung) zu berücksichtigen.

Der Mehrpreis wird, wie bei der Ausführung zu a), etwa 1000.-- bis 1200.-- RM betragen.

Vorstehende Ausführung ist nicht zweckmäßig.

c) Aus- und einfahrbarer Rost (Vorschlag).

Der Aufbau erhält einen ~~leichten~~ Bodenrost, der auf kleinen Rädern ausfahrbar gemacht wird. Er ist in 10 - 12 Querfelder zu unterteilen. Hierdurch wird er hand-

licher. Zudem wird ein Abkippen der einzelnen Felder beim Verlassen des Wagens möglich. Die Räder sind in U-Eisenlaufschienen zu führen. Ferner hat der Rost eine seitliche U-Eisenführung zu erhalten. Die Rostfelder sind durch Diagonalverspannungen gegen Verrecken zu sichern.

Um eine möglichst große Bodenfläche fahrbar zu machen, ist der Rost so hoch zu legen, daß die Radkästen mit überdeckt werden. Hierdurch gehen (gegenüber den Ausführungen zu a) und b)) nur etwa 75 mm an Innenraumhöhe verloren. Demgegenüber steht (nun) der Vorteil, daß man den Rost in der Breite der Tür fertigen kann. Die nicht vom Rost verdeckten schmalen (ca. 250 mm) Längsstreifen sind bis zur Höhe des Rostes auszufüllen und leicht zur Wagenmitte zu neigen. Dieser Holzaufbau ist mit den Wänden durchgehend mit glattem Blech zu verkleiden. Die vorstehenden Rückwandteile sind von den Türpfosten nach den Seitenwänden durch Bleche abzuschrägen. Die Abschrägung soll ein Anecken der Last verhindern. Für die Ausfahrung des Rostes ist unter dem hinteren Ende des Wagens eine Drahtseilwinde (Spill) anzubringen. Das Drahtseil ist geschert unter dem Rostteil anzubringen, der an der Führerhausrückwand liegt. Das andere Ende des Seiles ist mit einem Ring zu versehen und innen, in der Nähe der Tür, abnehmbar anzubringen. Nach Öffnen der Tür ist das Seil mit dem Ring an die Windentrommel anzuhängen. Die Trennung zwischen Seil und Trommel ist erforderlich, um mit Bezug auf die <sup>notwendige</sup> Seildurchführung eine Undichtigkeit des Wagenaufbaues auszuschließen.

Beim Anziehen der Seilwinde (Handbetrieb) nimmt der griffige Rost auch die Last mit, die auf den verblechten schmalen Längsstreifen ruht. Dies geschieht umso mehr, als die Längsstreifen zum Rost geneigt sind. Damit das Ladegut nicht über den letzten Rost zur

Führer-

- 3/ -

10.

Führerhaus-Rückwand fällt, ist dieser mit einem angewinkelten Gitterwerk von 3 - 400 mm Höhe zu versehen.

Die Räderlaufschienen und die seitlichen Führungsschienen sind so zu verlegen, daß sie von den Radkästen an zum Wagenende Gefälle haben. Die seitlich angebrachten U-Eisen-Schienen sind an ihrem Ende in halber Rößtbreite oben offen zu halten. Dadurch wird ein Abkippen des über das Wagenende hinaus ausgefahrenen Rostfeldes möglich.

Um zu verhindern, daß der Rost mit der Last abfällt und sich gegebenenfalls unter sie legt, sind die Rostfelder scharnierartig miteinander zu verbinden. (Türangel). Der ganze Rost stellt dann den Teil eines endlosen Bandes dar. Trotzdem lassen sich die Felder leicht aushaken.

Das jeweils freigewordene Rostfeld ist unter den Wagen zu biegen, damit die anderen Felder folgen können. Liegt das Ladegut gegen die bereits ausgefahrenen Rostfelder, so sind diese durch Anfahren des Wagens frei zu machen.

Der letzte Rost ist seitlich mit Zapfen zu versehen. Die Zapfen sollen in zwei Gabelführungen eingleiten, sobald dieser Rost den Wagen verläßt. Hierdurch wird erreicht, daß dieser Rost nicht abfallen kann. Er darf nicht abfallen, weil das Seil an ihm befestigt ist, und weil er beim Einfahren des Rostes die anderen Felder hinter sich herziehen soll. Unterbleibt diese Auffangvorrichtung, so ist man genötigt, den Rost auseinander zu nehmen und diese Felder einzeln wieder in die Schienen einzufahren. Sonst soll der Rost mit der Seilwinde wieder eingefahren werden.

(In diesem Falle erhält<sup>2</sup>) die Seilwinde 2 Drahtseile. Das Seil für das Ausfahren wird beispielsweise rechts und das für das spätere Einfahren links um die

Trommel



Trommel gelegt. Die Führung des Ausfahrseiles wurde bereits behandelt. Das Einfahrseil verläuft von der Trommel durch die geöffnete Tür über den Wagenboden zu einer Rolle, die an der Rückwand des Führerhauses unmittelbar über dem Boden angebracht wird. Von der Rolle wird das Seil zum Schlepprost geführt und dort gesichert angebracht. Die Trennung dieses Seiles, die auch beim Schließen der Wagentür notwendig ist, wird durch Karabinerhaken erreicht. Jedes der beiden Seile ist einmal Zugseil und einmal Schleppseil. >

3.) Dem  
 Gruppenleiter II D  
 4-Obersturmbannführer R a u f f -  
im Hause

mit der Bitte um Entscheidung vorgelegt. *11/11/54 Lösung zu 2.0) war die gegenüber vorigen ...*

*11/11/54*  
*Mag. ...*  
*Min. Lösung ...*  
*2.0) ...*  
*Handlung zu ...*  
*Raff*  
*Mantel ...*  
*14.*  
*wa 11/11/54*

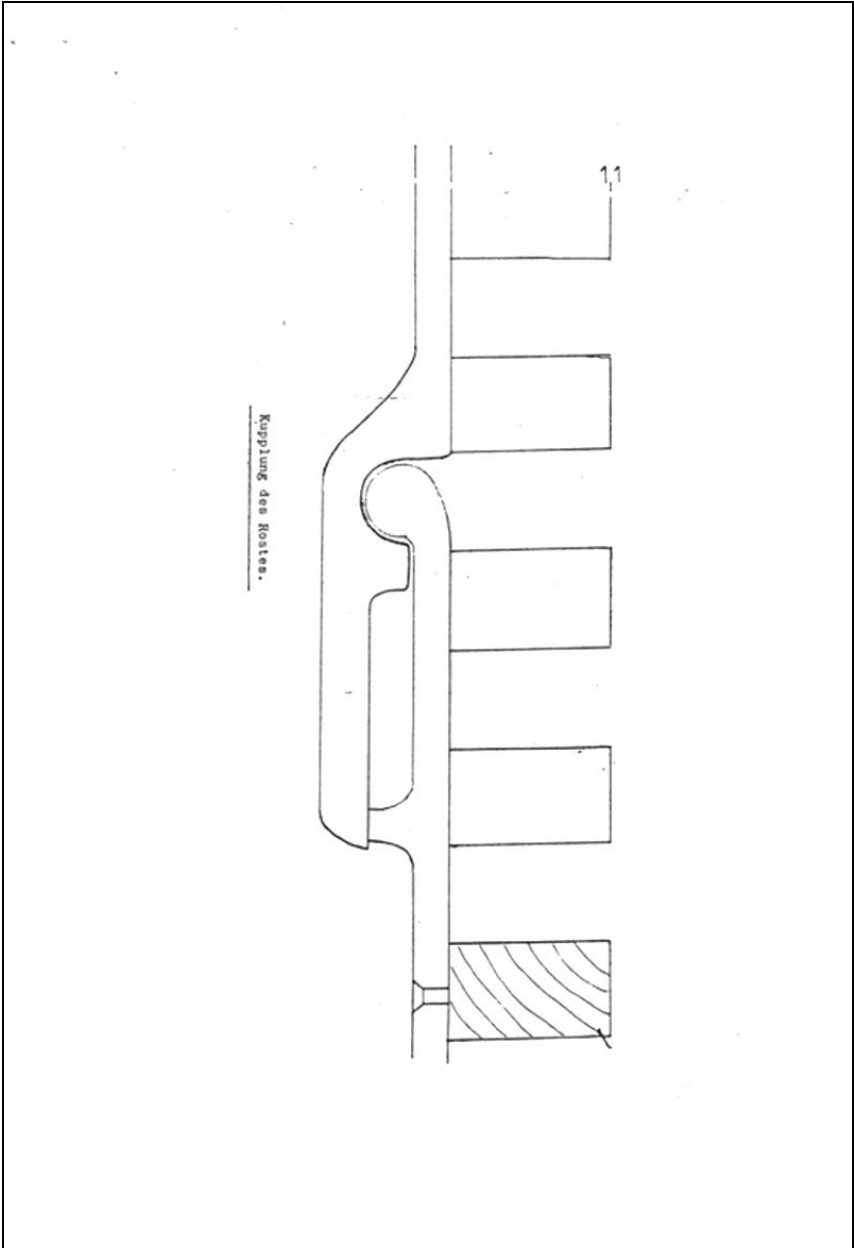

## Translation & Remarks

Imperial Security Main Office  
II D 3 a (9) Bo. 668/42-121.

Berlin, the 27th of April 1942.

1.) Reg.[istration]: under B.No. 1737/41, enter remark.

2.) Note:

Re.: Fast unloading device for the special vehicles.

The special vehicle's coachworks have a length of 5800 mm and a height of 1700mm. The net weight of the coachworks is 1600 kg each, while the loading weight is 4500 kg.

Unloading is said to occur fast and as automatically as possible. In order to achieve this, the coachwork or a second floor is to be made tiltable. Unloading may also be achieved by means of an extractable grate.

The below unloading options are to be assessed as to their functionality.

### a) Tilting mechanism for coachwork

For unloading the coachwork needs to be tilted by 30 – 35°. A hydraulic tipper with 5 – 7 tons capacity is needed to lift the gross weight (1600 + 4500 kg). It has a construction height of 650 mm and a lifting height of 900 mm.

Mounting a tipper ought to be considered as inexpedient for the following reasons:

The floor of the coachwork needs to be reinforced and equipped with a tipper frame (loss of payload).

In order to save construction height, it would be more expedient to mount twin tippers at the chassis girders. Such tippers are currently unavailable. The hydraulic single pillar tipper mentioned above has to be mounted on the reinforced traverse so high that it does not get in contact with the vibrating drive shaft. Due to this mounting and due to adding the tipper frame, the coachwork will be lifted by at least 200 mm. However, lifting the vehicle coachwork is impermissible, because this would exceed the railroad loading profile; except the interior space is reduced [in height]. But the interior already loses 150 mm in headroom due to the reinforcement of the floor.

Delivery time for the one pillar tippers is ½ to 1 year.

For implementing the design, which deviates strongly from the design defined earlier, the Gaubschat Company does not currently have the workforce.

Implementing the tipper delays the completion of the vehicles by another six weeks.

Each vehicle loses a payload of ca. 400 kg.

The surcharge for each vehicle is RM 1000.- to 1200.-.

b) Making for floor grate tiltable

The grate (second floor) has to be constructed particularly sturdy for a load of 4 ½ tons. Thereby the coachwork loses 150 mm of internal height. When constructing a continuous grate, the wheel cases have to be covered as well. This causes further loss of headroom.

Furthermore the tipper introduced through the floor will cause difficulties with regards to sealing the introduction site. Note that the tipper pillar does not lift evenly. It has to be able to tilt together with the second floor.

Moreover slipping of the load is a problem. For a flowing slide the floor has to have an inclination of 30 to 35°. The drawing illustrates that, even if the floor is lifted at the loose end up to the box ceiling, only an angle of 16° can be reached. In practice this tilt angle cannot be reached, because the load would be squeezed at the upper end of the loading surface. The highest lifting height, measured at the head wall, is probably 1000 mm. At this height the inclination of the floor would be merely 10°.

Moreover the loss of payload and time (for production) has to be considered.

As in design a), the surcharge is some 1000.- to 1200.- RM.

The above design is not expedient.

c) Ex- and retractable grate (suggestion).

The coachwork obtains a ~~lightweight~~ floor grate, which can be extracted on little wheels. It is to be subdivided into 10 – 12 transversal sections. This makes it easier to handle. In addition it enables each section to tip down on exiting the vehicle. The wheels are to be guided in iron U-shaped rails. Furthermore the grate has to obtain a lateral iron U-shaped guide rail. The grate sections are to be secured against canting by means of diagonal braces.

In order to make as large a floor surface extractable as possible, the grate is to be mounted sufficiently high to cover the wheel cases. Hence only some 75 mm in internal height are lost (in contrast to the designs in a) and b)). In contrast to this is the advantage that the grate can be made as wide as the door. The narrow lateral ledges not covered by the grate (ca. 250 mm) are to be filled up to the height of the grate and to be sloped toward the center of the vehicle. Together with the walls, this wooden structure is to be covered with smooth sheet metal. The protruding parts of the rear wall are to be beveled with sheet metal from the door frame to the side walls. This beveling is supposed to prevent a jamming of the load. For extracting the grate a cable winch (Spill) is to be mounted underneath the rear end of the vehicle. The cable is to be attached in a sheared way to the grate section located at the rear wall of the driver's cabin. The other end of the cable sports a ring and is to be attached in a removable way on the inside, close to the door. After opening the door the cable is to be attached to the winch drum using the ring. The separation between cable and winch is necessary in order to prevent a leakage of the coachwork with regards to the needed feedthrough of the cable.

When tightening the winch (manually), the non-slip grate also pulls along the load lying on the sheet metal covered lateral ledges. This all the more so as the lateral ledges slope toward the grate. In order that the load does not fall over the last grate [section] toward the rear wall of the driver's cabin, it is to be equipped with an angled gridwork of 3 to 400 mm height.

The wheel guide rails and the lateral guide rails are to be mounted in such a way that they slant downward from the wheel cases toward the vehicle's end. The lateral U-shaped iron rails are to be left open at the top at their end for half a grate section width. This enables the grate section moving out beyond the end of the vehicle to tip down.

In order to prevent that the grate falls down with the load and comes to rest beneath it, the grate sections are to be attached to one another in a hinge-like manner (door hinge). The entire grate is then a part of an endless belt. Nevertheless, the sections can be detached easily.

Each extracted grate section is to be bent beneath the vehicle so that subsequent sections can follow. If the load rests against the already extracted sections, these are to be cleared by moving the vehicle.

The last section is to be equipped with lateral pivots. The pivots are to glide into a forked track as soon as this section exits the vehicle.

This prevents this section from falling out. It must not fall out, because the cable is attached to it and because it has to pull the other sections along when the grate is being retracted. If this catching mechanism is omitted, one is forced to disassemble the grate and to reinsert the sections individually into the rail. Otherwise the grate will be retracted by the cable winch.

In this case the cable winch obtains 2 cables. The cable for extraction, for instance, is threaded clockwise and the one for the later retraction counterclockwise around the drum. The threading of the extraction cable has already been dealt with. The retraction cable runs from the drum through the open door along the vehicle's floor to a roller attached to the rear wall of the driver's cabin right above the floor. From the roller the cable is brought to the drag section and attached in a sheared manner. Detaching this cable, which also is necessary when closing the door, is achieved by means of a snap hook. Each of the cables is either a tow or a drag cable.

3.) To the

Group Leader II D

SS-Obersturmbannführer R a u f f –

in this house

presented with the request for a decision

[caption of illustration:] coupling of grate [section]

---

REMARKS: This text does not give the impression that it was authored by a technician; the terminology is naïve and the explanations rather incoherent. A German correspondent confirmed that this memo contains nonsensical items and uses uncommon terms. The description of the device listed under c), which is said to have been realized, is unclear; any reference to a guide roller at the vehicle's rear end is missing, whose installation would have been indispensable, since the winch was beneath the vehicle.

I have prepared a drawing about this device (see Illustration 21, p. 311), which is based on the information contained in the memo of 27 April 1942 as well as the confirmation letter of 30 April 1942. It shows the version which was eventually accepted according to these documents: A retractable floor grate. That the cable could be detached from the winch in order to avoid leakages of the cargo box is an indication

that even at this state of planning the cargo box was designed to be hermetically sealed, which could not have been accomplished with a cable permanently affixed to the winch beneath the car. This is contradicted, however, by the fact that already at that time the cargo box had openings in its doors covered with “sliders,” which according to the letter of 23 June 1942 were to be replaced with openings in the side walls with hinged lids (see p. 327). Hence the cargo box has never been without “leakage.”

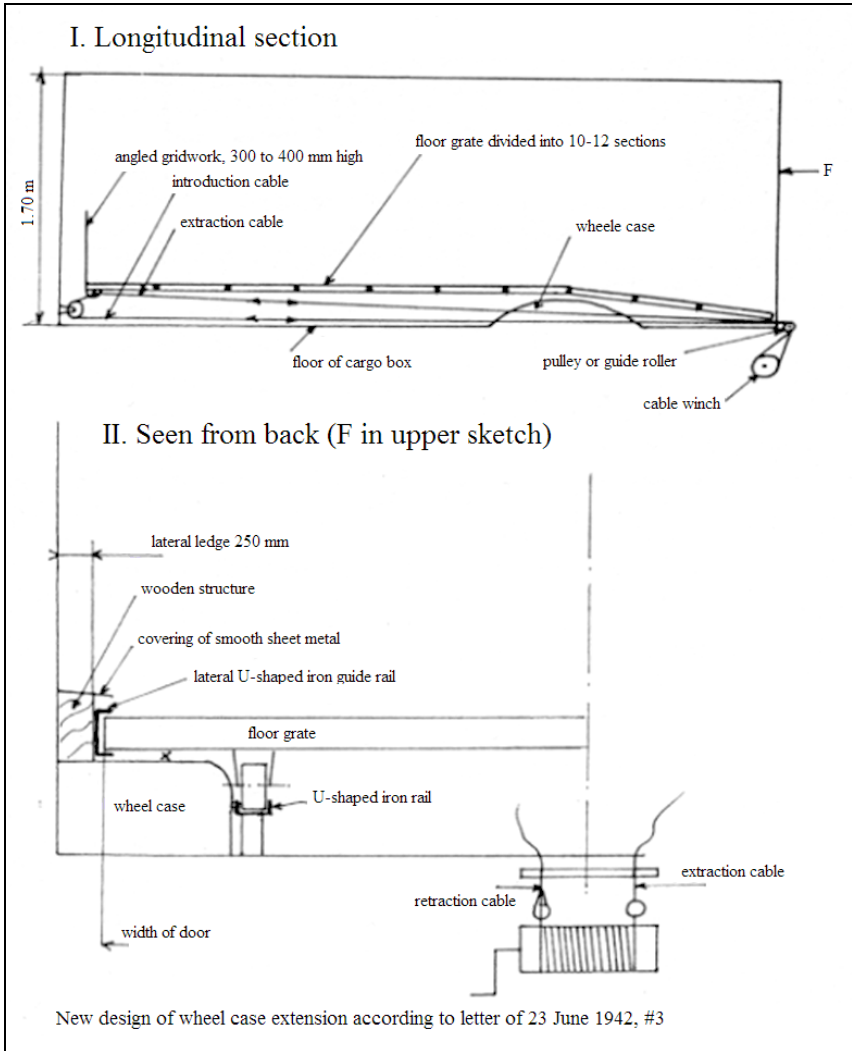

**Illustration 21:** Retractable grate for RSHA special vehicle according to suggestion c) of the memo of 27 April 1942; drawing by P. Marais.



Letter of 30 April 1942

<p>Der Chef der Sicherheitspolizei und des SD <u>II D 3 a (9) Nr. 668/42-121.</u></p>	<p>Berlin, den <u>30.</u> April 1942</p>
	<p>12</p>
<p><i>Nov. 1) + 3.) 90/11/15/42.</i></p>	<p>1.) <u>Schreiben:</u> An die Fa. <u>G a u b s c h a t</u> <u>Berlin-Neukölln</u> Willi Walter-Str.</p>
	<p>Ang. E 4A1 1942 Reichsicherheitshauptamt Adl.</p>
	<p><u>Betr.:</u> Angelieferte 10 Saurer-Fahrgestelle. <u>Bezug:</u> Unterredung mit Herrn Krieger am 23.u.24.4.42.</p>
	<p>Wie bereits besprochen, ist eine Abänderung des Bodenrostes für o.a. Fahrzeuge durchzuführen.</p>
	<p>Bei Fertigung desselben ist in konstruktiver Hinsicht folgendes zu beachten:</p>
	<p>Der Aufbau erhält einen <del>lichten</del> Bodenrost, der auf kleinen Rädern oder Rollen ausfahrbar zu machen ist. Er ist in 10 - 12 Querfelder zu unterteilen, damit ein Abkippen der einzelnen Felder beim Herausnehmen des Rostes möglich ist. Die Räder oder Rollen sind in U-Eisen-Laufschienen zu führen. Ferner hat der Rost eine seitliche U-Eisen-Führung zu erhalten. Die Rostfelder sind durch Diagonalverspannungen gegen Verecken zu sichern.</p>
	<p>Um eine möglichst große fahrbare Bodenfläche zu erhalten, ist der Rost so hoch zu legen, daß die Radkästen mit überdeckt werden. Hierdurch dürfen im Höchstfalle nur etwa 75 mm an Innenraumhöhe verloren gehen. Der Rost ist in der Breite der Tür zu fertigen. Die nicht vom Rost verdeckten schmalen (ca. 250 mm) Längsstreifen sind bis zur Höhe des Rostes auszufüllen und leicht zur Wagenmitte zu neigen. Dieser Holzaufbau ist mit den Wänden durchgehend mit glattem Blech zu verkleiden. Die vorstehenden Rückwandteile sind von den Türpfosten nach den Seitenwänden durch Bleche abzuschrägen. Für das Aus- und Einfahren des Rostes ist unter dem hinteren Ende des Wagens eine Drahtseilwinde (Spill) anzubringen. Das Drahtseil ist gesichert unter dem Rost-</p>
	<p><u>teil</u></p>

teil zu befestigen, das an der Führerhaus-Rückwand liegt. Das ~~andere~~ Ende des Seiles ist mit einem ~~Ring~~ <sup>in Höhe</sup> zu ~~verechen~~ <sup>verechen</sup> und innen, in der Nähe der Tür, abnehmbar anzubringen. Nach Öffnen der Tür ist das Seil ~~mit dem~~ <sup>an die</sup> Windentrommel anzuhängen. Die Trennung zwischen Seil und Trommel ist erforderlich, weil die sonst notwendige Seildurchführung eine Dichtigkeit des Wagenaufbaues in Frage stellt. Der erste Rost (Führerhaus-Rückwand) ist mit einem angewinkelten starken Gitterwerk von 3 - 400 mm Höhe zu versehen. Um ein Abfallen des gesamten Rostes beim Herabgewinden zu vermeiden, ist an diesem Rostteil eine Sicherung (Zapfen oder ähnliches) anzubringen. Die einzelnen Rostfelder sind scharnierartig miteinander zu verbinden. Trotzdem müssen sich die Felder leicht aushaken lassen.

Die Räderlaufschienen und die seitlichen Führungsschienen sind so zu verlegen, daß sie von den Radkästen an zum Wagenende Gefälle haben. Die seitlich angebrachten U-Eisen-Schienen sind an ihrem Ende in halber Rostbreite oben offen zu halten, ~~damit~~ <sup>um</sup> ein Abkippen des über das Wagenende hinaus ausgefahrenen Rostfeldes <sup>möglichst</sup> zu vermeiden.

Der Auftrag zur Fertigung der ausgefahrenen Roste für die 10 angelieferten Saurer-Fahrgestelle wird hiermit schon jetzt erteilt.

Das Angebot einschl. Konstruktionszeichnung ist nachträglich vorzulegen.

H D G

zur Mitzeichnung.

3.) Abschrift von 1.) zum Vorgang 1737/41 bei TGS Schmidt.

4.) Evl. 10.6.42.

I. A.

H D G H D

## Translation & Remarks

(Stamps and handwritten notes outside of text omitted)

The Head of the Security Police  
and the SD

Berlin, the 30th of April 1942

II D 3 a (9) No. 668/42-121

### 1.) Letter:

To the  
G a u b s c h a t Company  
Berlin-N e u k ö l l n  
Willi Walter-Str.

Reg.: Delivered 10 Saurer Chassis

Ref.: Discussion with Herr Krieger of 23 and 24 Apr. [19]42

As already discussed, a change of the floor grate of the above mentioned vehicles is to be implemented.

While producing selfsame, the following has to be considered regarding the design:

The coachwork obtains a floor grate, which is to be made extractable on small wheels or rollers. It is to be subdivided into 10 to 12 sections, hence permitting the individual sections to tip down when taken out the grate. The wheels or rollers are to be guided in a U-shaped iron rail. Furthermore the grate is to obtain a lateral U-shaped iron guide. The grate sections are to be secured against canting by means of diagonal braces.

In order to obtain as large a moveable floor surface as possible, the grate is to be mounted sufficiently high to cover the wheel cases. By so doing a maximum of only some 75 mm of interior headroom may be lost. The grate is to be manufactured at the width of the door. The narrow lateral ledges not covered by the grate (ca. 250 mm) are to be filled up to the height of the grate and to be sloped toward the center of the vehicle. Together with the walls, this wooden structure is to be covered with smooth sheet metal. The protruding parts of the rear wall are to be beveled with sheet metal from the door frame to the side walls. For the extracting and retracting of the grate a cable winch (Spill) is to be mounted underneath the rear end of the vehicle. The cable is to be attached in a sheared way to the grate section located at the rear wall of the driver's cabin. The ~~other~~ end of the cable ~~sports a ring and~~ is to be attached in a removable way on the [handwritten: vehicle's interior] in-

side, close to the door. After opening the door the cable is to be attached to the winch drum ~~using the ring~~. The separation between cable and winch is necessary because an otherwise needed feedthrough of the cable would jeopardize the tightness of the coachwork. The first grate [section] (rear wall of the driver's cabin) is to be equipped with an angled, strong gridwork of 3 to 400 mm height. In order to prevent that the entire grate falls down when winching it out, a catch is to be mounted on this section (pivot or similar). The individual grate sections are to be attached to one another in a hinge-like manner. Nevertheless, the sections need to be easily detachable.

The wheel guide rails and the lateral guide rails are to be mounted in such a way that they slant downward from the wheel cases toward the vehicle's end. The lateral U-shaped iron rails are to be left open at the top at their end for half a grate section width, in order to enable the grate section moving out beyond the end of the vehicle to tip down.

The order to manufacture the extractable grates for the 10 delivered Saurer chassis is given herewith already.

An offer including a construction drawing is to be submitted subsequently.

2.) II D 6:

for co-signature

3.) Copy of 1.) to case 1737/41 at TOS Schmidt.

4.) Resubmission 10 June [19]42

p.p.

[signed Rauff]

II D6 II D

REMARKS: This order following the internal memo of 27 April 1942 gives an almost identical, although somewhat less detailed description of the device as in the previous document (see drawing on p. 311). Here, too, the author stresses that, since the cargo box must not have any leakages, it has to be possible to detach the cable from the winch.

Letter of 14 May 1942

# Gaubschat

13

**Fahrzeugwerke GmbH.**  
Berlin-Neukölln, Willi-Walter-Straße 32-38

**Titl.**  
Der Chef der Sicherheitspolizei  
und des SD

Berlin SW 11  
Prinz-Albrecht-Str.8

<b>Drahtort:</b> Ferngespräch:	<b>Banken:</b>
<b>Fahrzeug:</b> Kennzahl-Nr. 623211	Commerzbank, Aktiengesellschaft,
Ab 18 Uhr: 623600	Berlin-Neukölln, Berliner Str. 44-46
<b>Adressat:</b> Chef d. Deutsch. Polizei	Dresdner Bank, Berlin, Dep.-Kasse 32,
der Sicherheitspolizei u. des SD	Berlin-Neukölln, Hermannstraße 148
	Berliner Stadtbank, Gluckstraße 51,
	Berlin-Neukölln, Richardstraße 115
	Postbank, Berlin 10516

16 5. 1942

Aufg. 1  
113

Ihre Zeichen: - Ihre Nachricht vom: 30.4.42 - Unsere Nachricht vom: - Unsere Abteilung: Verk. Wa/Ka. - Unser Sachbearbeiter: Wachsmuth 14.5.42

Betreff: Ihre Zeichen: II D 3 a (9) Nr. 668/42 - 121  
Uns. Kom. 63 424 - 433

Wir bestätigen den Empfang Ihres Schreibens vom 30. v. M., mit welchem Sie eine Änderung der noch zu liefernden 10 Sonder-Fahrzeuge aus obigem Auftrag bekanntgeben.

Unsere Betriebsleitung hat sich eingehend mit dieser Angelegenheit befaßt. Wir müssen Ihnen mitteilen, daß die gewünschte konstruktive Umgestaltung der bisherigen Rost-Ausführung in absehbarer Zeit von uns nicht durchgeführt werden kann. Für die hierzu notwendigen konstruktiven Arbeiten stehen uns z.Zt. keinerlei Kräfte zur Verfügung, da ein großer Teil auch des technischen Personals zur Wehrmacht eingezogen ist.

Ferner hat die Rückfrage zur Beschaffung der Seilwinden ergeben, daß hier Termine von ca. 10 bis 12 Monaten ~~erwartet~~ werden, so daß die restlichen 10 Fahrzeuge dann frühestens im Herbst n. J. zur Lieferung kommen könnten, womit Ihnen sicherlich nicht gedient ist.

Die Fertigung der Aufbauten ist von uns so eingereicht, daß die Lieferung in der zweiten Hälfte des n. M. erfolgen wird, vorausgesetzt, daß nicht unvorhergesehene Zwischenfälle eine Verzögerung notwendig machen.

Nach allem sind wir also nur in der Lage, die Fahrzeuge in derselben Ausführung herzustellen, wie die bereits gelieferten.

Wir bitten Sie, von Vorstehendem Kenntnis zu nehmen.

Heil Hitler!

Erfüllungen für Lieferung und Abholung ist für beide Teile Neukölln

Tit. 668 142  
18. Mai 1942  
Gaubschat Fahrzeugwerke GmbH.  
Santiago Alvarez

## Translation

(address field and preprinted stationary items omitted)

30 April 42          Verk. Wa/Ka.      Wachsmuth      18 May 42

Re.: Your Ref.: II D 3a (9) B.Nr. 668/42 – 121

Our Com. 63 424 – 433

---

We confirm receipt of your letter of the 30 of the previous month with which you inform us about a change to the 10 yet to be delivered vehicles of the above order.

Our management has dealt thoroughly with this matter. We have to inform you that, within the foreseeable future, we cannot implement the requested design changes to the type of grate produced so far. We currently do not have any personnel at our disposal needed for the construction tasks required for this, since a major part of our technical staff has been drafted by the Wehrmacht.

Furthermore the inquiry for the acquisition of the cable winch had as a result that delivery times of some 10 to 12 months are given for this, so that the remaining vehicles could be delivered during the fall at the earliest, which certainly does not serve you well.

The manufacture of the coachworks has been planned by us in such a way that they will be delivered in the second half of next month, provided that no unpredicted incidents necessitate a delay.

All in all we are now able to manufacture the vehicles with the same design as those delivered so far.

We request that you take note of the aforementioned facts.

Hail Hitler!

GAUBSCHAT VEHICLE WORKS, LTD.

Memo of 5 June 1942 (Just document)

. b-12-14

II D 3 a (9) Nr. 214/42 g.Bs. Berlin, den 5. Juni 1942

Einzigste Ausfertigung.

**Geheime Reichsache!**

1

I. Vermerk:

Betrifft: Technische Abänderungen an den im Betrieb eingesetzten und an den sich in Herstellung befindlichen Spezialwagen.

Seit Dezember 1941 wurden beispielweise mit 3 eingesetzten Wagen 97 000 verarbeitet, ohne daß Mängel an den Fahrzeugen auftraten. Die bekannte Explosion in Kulahof ist als Einzelfall zu bewerten. Ihre Ursache ist auf einen Bedienungsfehler zurückzuführen. Zur Vermeidung von derartigen Unfällen ergingen an die betroffenen Dienststellen besondere Anweisungen. Die Anweisungen wurden so gehalten, daß der Sicherheitsgrad erheblich heraufgesetzt wurde.

Die sonstigen bisher gemachten Erfahrungen lassen folgende technische Abänderungen zweckmäßig erscheinen:

- 1.) Um ein schnelles Einströmen des CO unter Vermeidung von Überdrücken zu ermöglichen, sind an der oberen Rückwand zwei offene Schlitze von 10 x 1 cm lichter Weite anzubringen. Dieselben sind außen mit leicht beweglichen Scharnierblechklappen zu versehen, damit ein Ausgleich des evtl. eintretenden Überdruckes selbsttätig erfolgt.
- 2.) Die Beschickung der Wagen beträgt normalerweise 9 - 10 pro m<sup>2</sup>. Bei den geräumigen Saurer-Spezialwagen ist eine Ausnutzung in dieser Form nicht möglich, weil dadurch zwar

keine

- 2 -

keine Überlastung eintritt, jedoch die Geländegängigkeit sehr herabgemindert wird. Eine Verkleinerung der Ladefläche erscheint notwendig. Sie wird erreicht durch Verkürzung des Aufbaues um ca. 1 m. Vorstehende Schwierigkeit ist nicht, wie bisher, dadurch abzustellen, daß man die Stückzahl bei der Beschiekung vermindert. Bei einer Verminderung der Stückzahl wird nämlich eine längere Betriebsdauer notwendig, weil die freien Räume auch mit CO angefüllt werden müssen. Dagegen reicht bei einer verkleinerten Ladefläche und vollständig ausgefülltem Laderaum eine erheblich kürzere Betriebsdauer aus, weil freie Räume fehlen.

In einer Besprechung mit der Herstellerfirma wurde von dieser Seite darauf hingewiesen, daß eine Verkürzung des Kastenaufbaues eine ungünstige Gewichtsverlagerung nach sich zieht. Es wurde betont, daß eine Überlastung der Vorderachse eintritt. Tatsächlich findet aber ungewollt ein Ausgleich in der Gewichtsverteilung dadurch statt, daß das Ladegut beim Betrieb in dem Streben nach der hinteren Tür immer vorwiegend dort liegt. Hierdurch tritt eine zusätzliche Belastung der Vorderachse nicht ein.

- 3.) Die Verbindungsschläuche zwischen Auspuff und Wagen rosten des öfteren durch, da sie im Innern durch anfallende Flüssigkeiten zerfressen werden. Um dieses zu vermeiden, ist der Einfüllstutzen nunmehr so zu verlegen, daß eine Einführung von oben nach unten erfolgt. Dadurch wird ein Einfließen von Flüssigkeiten vermieden.

4.)



- 4.) Um eine handliche Säuberung des Fahrzeuges vornehmen zu können, ist der Boden in der Mitte mit einer dicht verschließbaren Abflußöffnung zu versehen. Der Abflußdeckel mit etwa 200 bis 300 mm  $\phi$  erhält einen Syphonkrümmer, sodaß dünne Flüssigkeit auch während des Betriebes ablaufen kann. Zur Vermeidung von Verstopfungen ist der Krümmer oben mit einem Sieb zu versehen. Dicker Schmutz kann bei der Reinigung des Wagens durch die große Abflußöffnung fortgespült werden. Der Boden des Fahrzeuges ist zur Abflußöffnung leicht zu neigen. Hierdurch soll erreicht werden, daß alle Flüssigkeiten unmittelbar zur Mitte abfließen. Ein Eindringen der Flüssigkeiten in die Röhren wird somit weitgehendst unterbunden.
- 5.) Die bisher angebrachten Beobachtungsfenster können entfallen, da sie praktisch nie benutzt werden. Bei der Fertigung weiterer Fahrzeuge wird durch den Fortfall der Fenster mit Bezug auf die schwierige Anbringung und dichte Abschließung derselben erhebliche Arbeitszeit eingespart.
- 6.) Die Beleuchtungskörper sind stärker als bisher gegen Zerstörungen zu sichern. Das Eisengitterwerk ist so hoch gewölbt über den Lampen anzubringen, daß eine Beschädigung der Lampenfenster nicht mehr möglich ist. Aus der Praxis wurde vorgeschlagen, die Lampen entfallen zu lassen, da sie angeblich nie gebraucht werden. Es wurde aber in Erfahrung gebracht, daß beim Schließen der hinteren Tür und somit bei eintretender Dunkelheit immer ein starkes

Drängen

- 4 -

Drängen der Ladung nach der Tür erfolgte. Dieses ist darauf zurückzuführen, daß die Ladung bei eintretender Dunkelheit sich nach dem Licht drängt. Es erschwert das Einklinken der Tür. Ferner wurde festgestellt, daß der auftretende Lärm wohl mit Bezug auf die Unheimlichkeit des Dunkels immer dann einsetzt, wenn sich die Türen schließen. Es ist deshalb zweckmäßig, daß die Beleuchtung vor und während der ersten Minuten des Betriebes eingeschaltet wird. Auch ist die Beleuchtung bei Nachtbetrieb und beim Reinigen des Wageninnern von Vorteil.

- 7.) Um eine schnelle und leichte Entladung des Fahrzeuges zu erreichen, ist ein ausfahrbarer Rost anzubringen. Er ist auf kleinen Rädern in U-Eisen-Schienen zu führen. Das Aus- und Einfahren hat mit einer unter dem Wagen angebrachten Drahtseilzugwinde zu geschehen. Die mit der Anbringung beauftragte Firma hält diese Ausführungsart wegen Kräfte- und Materialmangel z.Zt. für undurchführbar. Die Ausführung ist bei einer anderen Firma anzuregen.

Vorstehende technische Abänderungen sind an den im Betrieb befindlichen Fahrzeugen nur dann nachträglich auszuführen, wenn jeweils ein Fahrzeug einer anderen größeren Reparatur unterzogen werden muß. An den in Auftrag gegebenen 10 Saurer-Fahrgeräten sind die vorstehenden Abänderungen so weit als möglich zu berücksichtigen. Da die Herstellerfirma gelegentlich einer Rücksprache betonte, daß konstruktive Abänderungen z.Zt. nicht oder nur für kleinste Abänderungen möglich sind, ist bei einer anderen Firma der Versuch zu unternehmen, mindestens

eines

- 5 -

3

eines dieser 10 Fahrzeuge mit allen Neuerungen und Abänderungen, die sich bisher aus der Praxis ergaben, auszustatten. Ich schlage vor, die Firma in Hohenmauth mit der Einzelausführung zu beauftragen.

Nach den Umständen ist bei diesem Fahrzeug mit einer späteren Fertigstellung zu rechnen. Es ist dann nicht nur als Muster-, sondern auch als Reserve-Fahrzeug bereitzuhalten bzw. einzusetzen. Bei Bewährung sind die übrigen Fahrzeuge nacheinander aus dem Betrieb zu ziehen und dem Musterfahrzeug entsprechend umzubauen.

II. Gruppenleiter II D  
#-Obersturmbannführer R a u f f

mit der Bitte um Kenntnissnahme und Entscheidung vorgelegt.

*R 10/6*

*J. A.*  
*J. A.*

*L. 4/6.*  
wh

For a translation see chapter 2.2.4.1. See my comments in chapters 2.2.4. and 2.2.5.

Memo and Letter of 23 June 1942

Der Chef der Sicherheitspolizei und des SD	Berlin, den 23. Juni 1942
<u>II D 3 a (9) B.Nr. 668/42</u>	4
1.) <u>Vermerk:</u>	
Lt. Vorgang II D 3 a -1737/41- sind bei der Fa. Gaub- schat 30 Spezialaufbauten für angelieferte Fahrge- stelle in Auftrag gegeben. 20 Fahrzeuge sind bereits fertiggestellt und ausgeliefert.	
Die letzten 10 Fahrgestelle wurden jetzt ange- liefert und sollen mit Aufbauten versehen werden. Ob- wohl die Firma Gaubschat nicht in der Lage ist, die aus der Erfahrung notwendig gewordenen Abänderungen im laufenden Bauplan zu berücksichtigen, hat der Gruppenleiter auf Vorschlag entschieden, daß trotz- dem alle Aufbauten bei der Firma Gaubschat gefertigt werden, da die in Erwähnung gezogene Firma Sodomka in Hohenmauth für eine Geheimhaltung nicht geeignet erscheint. (Tschechische Firma in rein tschechischem Gebiet mit tschechischen Arbeitern).	
Es wird vorgeschlagen, bei der Firma Gaubschat die im nachfolgenden Schreiben aufgeführten Änderun- gen bei zunächst 1 Aufbau auszuführen und praktisch zu erproben. Änderungen, die zum Zwecke der Geheim- haltung dort nicht berücksichtigt werden können, sind in eigener Werkstatt vorzunehmen.	
2.) <u>Schreiben:</u>	
An die Firma Fahrzeugwerke Gaubschat	
<u>Berlin - Neukölln</u> Willi Walterstr.	
<u>Betrifft:</u> Aufbauten für angelieferte 10 Saurerfahr- gestelle.	
<u>Bezug:</u> Schreiben Verk. Wa/Ka. vom 14.5.42 Kon. 63429 - 433.	

*Handwritten notes:*  
Befehl im 23.6.42  
an die Fa. Gaub-  
schat 23/6/42

*Redacted line at the bottom of the page.*

Vor Inangriffnahme der Fertigung der 10 Aufbauten wird gebeten, zu den in o.a. Schreiben und den am 16.6.42 zwischen Ihrem Herrn Ernst und Krüger und unserem techn. Ober-Sekr. a.Pr. Sukkel mündlich erörterten Abänderungen der Aufbauten folgendes zur Kenntnis zu nehmen:

Die Herstellung der Aufbauten hat im allgemeinen in der bisherigen Ausführung zu erfolgen. Wie bereits mündlich besprochen, sind noch folgende Abänderungen vorzunehmen:

- 1.) Der Kastenaufbau ist in seiner Länge um 800 mm zu verkürzen. Der Wulst an der Tür fällt fort. Der Einwand, daß durch die Verkürzung eine ungünstige Gewichtsverteilung herbeigeführt würde, wird hiermit zur Kenntnis genommen. Etwaige hieraus entstehende Nachteile werden gegenüber der Firma Gaubschat nicht beanstandet werden.
- 2.) Die beiden Radkästen sind nach vorn und hinten zu verlängern, so daß ein durchgehender Aufsatz an beiden Seitenwänden geschaffen wird.
- 3.) Da die jetzige Ausführung der Roste zu umständlich ist, sind die Roste nur in einer Länge von 700 mm zu fertigen und abweichend von der jetzigen Ausführung auf den unter 2) durchgehend eingebauten Radkastenaufsatz aufzulegen. Die Stützen der Roste auf dem Kastenboden sind beizubehalten.
- 4.) Die beiden Türecken sind durch eine feste Verkleidung abzudecken. Die Verkleidung ist von dem Türpfosten bis ca. 1/2 m in das Kasteninnere vorzunehmen, so daß zu den Türen eine Verjüngung des Kasteninnern erwirkt wird.
- 5.) Die durch Schieber verdeckten Öffnungen an den hinteren Türen fallen fort und sind durch offene Schlitzlöcher von 100 x 10 mm in der oberen Rückwand (nicht Tür) zu ersetzen. Sie sind außen mit leicht beweglichen Scharnierblechklappen zu verdecken.
- 6.) Die im rechten vorderen Kastenboden befindliche Abflußöffnung mit Verschluss fällt fort, dafür wird eine ca. 200 mm ø große Abflußöffnung im Kastenboden

5

eingeschnitten. Diese Abflußöffnung ist mit einem starken und dicht schließenden Scharnierdeckel zu versehen, der von außen fest und sicher geöffnet und geschlossen werden kann.

7.) Die Innenlampen sind mit einem hoch gewölbten und stärkeren als bisher verwandten Gitter zu schützen.

Es wird gebeten, 1 Fahrzeug schnellstens bevorzugt fertigzustellen und den Termin der Auslieferung der restlichen 9 Fahrzeuge schon jetzt bekanntzugeben.

3.) Wv. 20.7.42.

I.A.

A handwritten signature in dark ink, appearing to be 'J. Alvarez', written in a cursive style.

Sp. 23

## Translation & Remarks

(Stamps and handwritten notes outside of text omitted)

The Head of the Security Police  
and the SD

Berlin, the 23rd of June 1942

II D 3 a (9) Letter No. 668/42

### 1.) Memo:

Acc. to case II D 3 a –1737/41– 30 special coachworks for the delivered chassis have been ordered from the Gaubschat Company. 20 vehicles have already been completed and delivered.

The last 10 chassis have now been delivered and are to be equipped with coachworks. Although the Gaubschat company is unable to consider the necessary changes gained from experience, the group leader has decided on suggestion that all coachworks are nevertheless to be manufactured by the Gaubschat company, since the Sodomka company in Hohenmauth, which had been taken into consideration, does not seem to be suited for secrecy. (Czech company in a purely Czech area with technical staff.)

It is suggested to implement initially in 1 coachwork the changes listed in the following letter and to test them in practice. Changes which cannot be considered there for reasons of secrecy are to be made in an in-house workshop.

### 2.) Letter:

To the  
Vehicle Works Gaubschat

Berlin Neukölln  
Willi Walterstr.

Reg.: Coachworks for 10 delivered Saurer Chassis

Ref.: Letter sales Wa/Ka. Of 14 May [19]42, Kom. 63429-433.

Before initiating the production of the 10 coachworks we ask to take note of the following regarding the changes to the coachworks as discussed in the above mentioned letter and as discussed in person on 16 June [19]42 between your Herr Ernst and Herr Krüger and our technical head secretary a. Pr.[?] Sukkel:

In general the production of the coachworks has to be done following the previous design. As discussed in person, the following changes are to be made:

- 1.) The cargo box is to be shortened by 800 mm in length. The protrusion at the door is omitted. The objection is herewith acknowledged that the shortening would result in a disadvantageous weight distribution. The Gaubschat Company will not be held liable for any disadvantages resulting from this.
- 2.) Both wheel cases are to be extended forward and backward so that a continuous box is created at both side walls.
- 3.) Since the current design of the grates is too cumbersome, the grates [sections] are to be produced in a length of only 700 mm and, in deviation from the current design, are to be put onto the continuous wheel case box of no. 2.)
- 4.) Both door corners are to be covered with a solid cover. This cover is to run from the door jambs to ½ m into the interior of the cargo box, so that the interior of the cargo box tapers off toward the doors.
- 5.) The openings covered by sliders at the rear doors are omitted and are to be replaced with open slits of 100 × 10 mm in the upper rear wall (not door). They are to be covered on the outside with hinged flaps.
- 6.) The drainage opening with lid in the floor on the right in the front part of the cargo box is omitted, and in its stead a drainage opening of ca. 200 mm diameter is cut into the box floor. This opening is to be closed with a strong and tight hinged lid which can be opened and closed firmly and safely from the outside.
- 7.) The internal lights are to be protected with a highly domed grid-work stronger than the one used so far.

It is requested to produce 1 vehicle as fast as possible and to announce the delivery date of the remaining 9 vehicles already now.

3.) Resubmission 20 July [19]42.

p.p.

---

REMARKS: No reason is given for the demand to shorten the cargo box. In my analysis of the Just document (2.2.4.), which addresses this issue under #2, I have discussed the claim that a shortening of the cargo box would lead to an “unfavorable distribution of weight.”



Here we are told that the doors contained “openings covered with sliders,” which means that the cargo box has never been hermetically sealed, as sliders may be able to cover openings, but they cannot seal them. In their stead regular openings were requested for the new vans, which were to be covered with a mere hinged flap. Any minor overpressure in the cargo box would have lifted those flaps and allowed excess gas to escape, hence these cargo boxes would have “leaked” constantly.

Considering the obvious lack of “freedom from leakage” of this design, it is a riddle why the RSHA insisted in earlier letters that the cable used to move the floor grate can be detached from the winch to avoid such a leakage (see memo of 27 April 1942 and letter of 30 April 1942).

### Juxtaposition of Two Documents

The following is a juxtaposition of some of the seven point listed in the RSHA letter to the Gaubschat company of June 23, 1942, with the corresponding points of the plagiarized “file memo” of June 5, 1942 (the “Just document”). Incriminating text passages are rendered in bold (taken from Weckert 2003, p. 234).

LETTER OF JUNE 23, 1942	“FILE MEMO” OF JUNE 5, 1942
<p>“1. <i>The cube body is to be reduced in length by 800 mm [31.5"]. [...] We herewith acknowledge the objections raised, that such a shortening would cause a disadvantageous distribution of weight. [The preceding text shows that this objection was raised by Gaubschat on the occasion of a verbal discussion on June 16, 1942.] Any disadvantages resulting herefrom will not be complained of to the firm of Gaubschat.</i>”</p>	<p>“2. <i>It would seem necessary to decrease the load area. This will be achieved by shortening the body by approximately 1 m [39"]. The above problem cannot be solved, as has been attempted, by reducing the number of objects per load. <b>This is because a reduction in the number necessitates a longer operation time, since the empty space also must be filled with CO.</b> [...] In a discussion with the manufacturer it was pointed out by the latter that a shortening of the cube body would result in a disadvantageous weight displacement. <b>In fact, however, an involuntary balancing in weight distribution occurs because during operation the load strives towards the back door and always largely ends up there.</b>”</i></p>
<p>“5. <i>The slide-covered openings in the rear doors are to be omitted, and replaced with open slits of 100 × 10 mm [4" × 0.4"] in the upper back wall (not</i></p>	<p>“1. <i>To allow for the rapid inflow of the CO while preventing excessive pressure, two open slits of 10 × 1 cm [4" × 0.4"] are to be located in the upper</i></p>

LETTER OF JUNE 23, 1942	"FILE MEMO" OF JUNE 5, 1942
<p>door). They are to be covered on the outside with easily movable, hinged metal flaps."</p>	<p>back wall. These are to be covered on the outside with easily movable, hinged metal flaps <b>to allow for self-regulation of any potential excess pressure.</b>"</p>
<p>"6. The closeable drain opening in the right front part of the cube floor is to be omitted. Instead, a drain opening of about 200 mm [9"] in diameter is to be cut into the cube floor. This opening is to have a strong, tight-fitting, hinged lid that can be closed and safely opened from outside."</p>	<p>"4. To allow for easy cleaning of the vehicle [this expression builds on the implied allegation that the gassed people were covered with excrement and filth and had dirtied the vehicle accordingly], a tightly closeable drain opening is to be located in the center of the floor. The drain cover, about 200 to 300 mm [8" to 12"] in diameter, is to be equipped with a U-trap <b>so that thin fluid can also drain out during operation.</b>" [This too is a reference to excretions from the dying people.]</p>
<p>"7. The interior lights are to be protected with a domed wire guard that is stronger than that used to date."</p>	<p>"6. The lighting appliances are to be more strongly protected from destruction than they have been so far. The iron grid guard over the lamps is to be domed enough to render damage to the lamp glass no longer possible. From practical experience it was suggested that the lamps should be omitted altogether, since allegedly they are never needed. <b>It was found, however, that when the back door is closed, i.e., when the interior becomes dark, the load urgently strives towards the door. This is because, at the onset of darkness, the load strives towards the light.</b> [Utter nonsense. Once the door was closed, it would have been no lighter there than in the rest of the cube body.] <b>Further, it was found that a commotion, probably due to the eerie nature of darkness, always breaks out at the point where the doors are closed. For this reason it would be expedient to turn the lights on before and during the first minutes of operation.</b>"</p>

Letter of 18 September 1942

# Gaubschat

6

**Fahrzeugwerke GmbH.**  
Berlin-Neukölln, Will-Walter-Straße 32-38

**Titel.**  
Der Chef der Sicherheitspolizei  
und des SD

Berlin SW 11  
Prinz-Albrecht-Str. 8

Gebühren: Fernsprecher: Buchen:  
Fahrpost: Sammel-Nr. 62211

Abteilung: Abt. 10, Hauptstadt, Berlin-Neukölln, Berlin Str. 44-46  
Der RF H. u. Chef d. Deutsch. Polizei  
Der Chef der Sicherheitspolizei u. des SD  
Hauptstadt, Hermannstraße 108  
Hauptstadt, Stralauer Str. 11  
Berlin-Neukölln, Richardstraße 116  
Postfach: Berlin 100 10

20. 9. 1942

Abt.: 183a

Am: 183a

<small>Ihre Zeichen:</small>	<small>Ihre Nachricht vom:</small>	<small>Unsere Nachricht vom:</small>	<small>Unsere Abteilung:</small>	<small>Unser Sachbearbeiter:</small>	<small>Tag:</small>
-	23.6.42	-	Verk.Na/Ka.	Wachsmuth	18.9.42

**Betreff:** Uns.Kom. 63 424 - 433 / 64 523  
Ihre Zeichen: II D 3 a (9) B.Nr. 668/42  
Aufbauten für angelieferte 10 Saurerfahrgestelle

-----

Wir bestätigen den Empfang Ihres Schreibens vom 23. d. M., mit welchem Sie Bezug nehmen auf die Verhandlung zwischen Ihrem techn. Ober-Sekr. a. Pr. Sukkel und unseren Herrn Ernst und Krieger.

Ausnahmsweise sind wir nunmehr bereit, die restlichen 10 Fahrzeuge unter Berücksichtigung der in Ihrem Schreiben vom 23. d. M. angeführten 7 Punkte auszuführen.

Es kommt noch weiter hinzu, daß (Punkt 8.) die Kästen oben mit verzinktem Eisenblech belegt werden.

Durch diese gewünschten Änderungen ändert sich auch der Preis.

Dieser beträgt nunmehr

Reichsmark 4.051,85 pro Stück

für die restlichen 10 Aufbauten.

Wir werden ein Fahrzeug schnellstens im Rahmen der Fabrikationsmöglichkeit bevorzugt fertigstellen.

Über die Lieferung der 9 restlichen Fahrzeuge hoffen wir, Ihnen in den nächsten Tagen Bescheid geben zu können.

Heil Hitler!

GAUBSCHAT FAHRZEUGWERKE GMBH.

*W. Wachsmuth* *M. Krieger*

Nr. 668 162

E 93a (9) 22. Sep. 1942

Datierung: *M. Wachsmuth*

Translation

(address field and preprinted stationary items omitted)

23 June 42            Verk. Wa/Ka.    Wachsmuth    18 Sept. 42

Re.: Our Com. 63 424 – 433 / 64 523

Your Ref.: II D 3a (9) B.Nr. 668/42

Coachwork f. delivered 10 Saurer Chassis

---

We confirm receipt of your letter of the 23rd of the current month with which you refer to the negotiation between your technical Senior Secretary a. Pr. Sukkel and our Mr. Ernst and Krieger.

As an exception we are now prepared to engineer the remaining 10 vehicles while taking into account the seven points listed in your letter of the 23rd of this month.

To be added to this is that (point 8) the boxes are lined with zinc-plated sheet iron.

Due to this requested change the price changes as well.

It is now

Reichsmark 4,051.85 per piece

for the remaining 10 coachworks.

We will complete one vehicle as fast as possible within the framework of our production possibilities.

We hope to be able to inform you about the delivery of the remaining 9 vehicles within the next days.

Hail Hitler!

GAUBSCHAT VEHICLE WORKS, LTD.

Letter of 24 September 1942

14

# Gaubtschat Fahrzeugwerke GmbH.

**Gaubschat** Berlin-Neukölln, Wilm - Walter - Straße 32 - 38

**Telefon:** Berlin-Neukölln, Wilm - Walter - Straße 32 - 38  
**Postfach:** Berlin 100 60

**Titel:**  
 Der Chef der Sicherheitspolizei  
 und des SD

**Berlin SW 11**  
 Prinz-Albrecht-Str. 8 25 9 1942

**ANKEN:**  
 Der RFH u. Chef d. Deutsch. Polizei  
 Der Chef der Sicherheitspolizei u. d. SD  
 Berlin SW 11, Prinz-Albrecht-Str. 8 25 9 1942

**Unsere Abteilung:** Verk. Wa/Ka.  
**Unser Sachbearbeiter:** Wachsmuth 24.9.42

**Betreff:**  
 Uns.Kom. 63 424 - 433 / 64 523  
 Ihre Zeichen: II D 3 a (9) B.Nr. 668/42  
 Aufbauten f. angelieferte 10 Saurerfahrgestell

Wir beabsichtigen nunmehr, die restlichen Fahrzeuge aus obigem Auftrag in Fabrikation zu nehmen. - Wir bitten hiermit höflichst um Besuch eines Ihrer maßgebenden Herren für diesen Geschäftsfall zur Rücksprache bei unserer Betriebsleitung, Herrn Prokurist Baum.

Sie wollen bitte vor Ihrem Besuch sich telefonisch mit Herrn Baum in Verbindung setzen und den genauen Termin festlegen.

Heil Hitler!

GAUBTSCHAT FAHRZEUGWERKE GMBH.

*[Handwritten Signature]*

Nr. 668 112  
 26. Sep. 1942

*[Handwritten: 26.9.42]*

Translation

(address field and preprinted stationary items omitted)

– Verk. Wa/Ka. Wachsmuth 24 Sept. 42

Re.: Our Com. 63 424 – 433 / 64 523

Your Ref.: II D 3a (9) B.Nr. 668/42

Coachwork f. delivered 10 Saurer Chassis

---

We now intend to take into manufacture the remaining vehicles from the above order. We herewith politely request a visit of one of your authorized gentlemen for this business case for consultation with our management, Mr. Commissioner Baum.

Please get in touch by phone with Mr. Baum before your visit in order to arrange for an exact appointment.

Hail Hitler!

GAUBSCHAT VEHICLE WORKS, LTD.

# Appendix 5: Published Versions of the Just Document

See my comments in chapters 2.2.4. and 2.2.5.

- 2 -

keine Überlastung eintritt, jedoch die Gelände-  
 eignigkeit sehr herabgemindert wird. Eine Ver-  
 kleinerung der Lederfläche erscheidet notwendig.  
 Sie wird erreicht durch Verkürzung des Auf-  
 baues um ca. 1 m. Vorstehende Schweißrigel-  
 ist nicht, wie bisher, dadurch abzustellen,  
 daß man die Stückzahl bei der Beschickung ver-  
 mindert. Bei einer Verminderung der Stückzahl  
 wird nämlich eine längere Betriebsdauer not-  
 wendig, weil die freien Räume auch mit CO an-  
 gefüllt werden müssen. Dagegen reicht bei  
 einer verkleinerten Lederfläche und vollstän-  
 dig ausgefülltem Laderaum eine erheblich kür-  
 zere Betriebsdauer aus, weil freie Räume feh-  
 len.

In einer Besprechung mit der Herstel-  
 lerfirma wurde von dieser Seite darauf hinge-  
 wiesen, daß eine Verkürzung des Kastenaufbaues  
 eine ungünstige Gewichtverlagerung nach sich  
 zieht. Es wurde betont, daß eine Überlastung  
 der Vorderachse eintritt. Tatsächlich findet  
 aber ungewollt ein Ausgleich in der Gewichts-  
 verteilung dadurch statt, daß das Ladegut beim  
 Betrieb in dem Straben nach der hinteren Tür  
 immer vorwiegend dort liegt. Hierdurch tritt  
 eine zusätzliche Belastung der Vorderachse  
 nicht ein.

3.) Die Verbindungsschläuche zwischen Aus-  
 puff und Wagen rosten des öfteren durch, da  
 sie im Innern durch anfallende Flüssigkeiten  
 zerfressen werden. Um dieses zu vermeiden, ist  
 der Zinkfaluutzen nunmehr so zu verlegen, daß  
 eine Einföhrung von oben nach unten erfolgt.  
 Dadurch wird ein Einfliessen von Flüssigkei-  
 ten vermieden.

b-17-14  
 Berlin, den 5. Juni 1942  
 Einzige Aufertigung

**Geheime Reichsgeheimnis!**

I. Y. E. R. S. T. Y.

Betrifft: Technische Änderungen an den in Be-  
 trieb eingesetzten und an den sich in  
 Herstellung befindlichen Spezialwagen.

Seit Dezember 1941 wurden beispielsweise  
 mit 3 eingeschritten Wagen 97 000 verarbeitet,  
 ohne daß Mängel an den Fahrzeugen auftraten. Die  
 gesamte Produktion im Kulkhof ist als Einzelstall  
 zu bewerten. Ihre Ursache ist auf einen bedie-  
 nungsfehler zurückzuführen. Zur Vermeidung von  
 Acetatigen Unfällen vergingen an die betroffenen  
 Eisenstalten besondere Anweisungen. Die Anwei-  
 sungen wurden so gehalten, daß der Sicherheits-  
 grad schablich heraufgesetzt wurde.

Die sonstigen blauen gemachten Erfah-  
 rungen lassen folgende technische Abänderungen  
 zweckmäßig erscheinen:

1.) Um ein schnelleres Einstreichen des CO unter Ver-  
 meidung von Überdruck zu ermöglichen, rüch-  
 an der oberen Rückwand zwei offene Schlitze  
 von 10 x 1 cm lichter Weite anzuordnen. Die-  
 selben sind außen mit leicht beweglichen  
 Schieberblendeklappen zu versehen, damit ein  
 Ausgleich des evtl. einströmenden Überdruckes  
 selbsttätig erfolge.

2.) Die Beschickung der Wagen beträgt normaler-  
 weise 9—10 pro m<sup>3</sup>. Bei den großartigen  
 Sauerstoffabnahmen ist eine Ausnutzung in  
 dieser Form nicht möglich, weil dadurch immer  
 keine

1. Reproduction in Kogon et al. 1983, pp. 333-337

<p style="text-align: center;">- 3 -</p> <p>4.) Um eine handliche Säuberung des Fahrzeuges vornehmen zu können, ist der Boden in der Mitte mit einer dicht verschließbaren Abflußöffnung zu versehen. Der Abflußbockel mit etwa 200 bis 300 mm <math>\phi</math> erhält einen Synchro-Krümer, sodaß dünne Flüssigkeit auch während des Betriebes ablaufen kann. Zur Vermeidung von Verstopfungen ist der Krümer oben mit einem Sieb zu versehen. Dicker Schmutz kann bei der Reinigung des Weges durch die große Abflußöffnung fortgespült werden. Der Boden des Fahrzeuges ist zur Abflußöffnung leicht zu neigen. Hierdurch soll erreicht werden, daß alle Flüssigkeiten unmittelbar zur Mitte abfließen. Ein Hindringen der Flüssigkeiten in die Röhren wird somit weitgehendst unterbunden.</p> <p>5.) Die bisher angebrachten Beobachtungsfenster können entfallen, da sie praktisch nie benutzt werden. Bei der Fertigung weiterer Fahrzeuge wird durch den Fortfall der Fenster mit Bezug auf die schwerere Abbringung und dichte Abschließung derselben erhebliche Arbeitszeit eingespart.</p> <p>6.) Die Beleuchtungskörper sind stärker als bisher gegen Zerstörungen zu sichern. Das Flammglitternetz ist so hoch geschlöt über dem Lampen anzubringen, daß eine Beschädigung der Lampenfenster nicht mehr möglich ist. Aus der Praxis wurde vorgeschlagen, die Lampen entfallen zu lassen, da sie angeblich nie gebraucht werden. Es wurde aber in Erfahrung gebracht, daß beim Schließen der hinteren Tür und somit bei starkem Dunkelheit immer ein starkes</p> <p style="text-align: right;"><u>Drängen</u></p>	<p style="text-align: center;">4</p> <p>Drängen der Leuchte nach der Tür erfolgte. Dieses ist darauf zurückzuführen, daß die Leuchte bei einsetzender Dunkelheit sich nach dem Licht drängt. Es erscheint das Einklinken der Tür. Fehler wurde festgestellt, daß der auftretende Licht wohl mit Bezug auf die Unbeilichkeit des Dunkelstimmer dann einsetzt, wenn sich die Tür von schließen. Es ist deshalb zweckmäßig, daß die Beleuchtung vor und während der ersten Minuten des Betriebes eingeschaltet wird. Auch ist die Beleuchtung bei Nachtbetrieb und beim Heizen des Wageninnern von Vorteil.</p> <p>7.) Um eine schnelle und leichte Entladung des Fahrzeuges zu erreichen, ist ein ausfahrbarer Host anzubringen. Er ist auf kleinen Rädern in U-Eisen-Schienen zu führen. Den Aus- und Einfahren hat mit einer unter dem Wagen angebrachten Irrhülsenlaufwinde zu geschehen. Die mit der Anbringung beauftragte Firma hält diese Ausführungsart wegen Kräfte- und Materialmangel z.Zt. für undurchführbar. Die Ausführung ist bei einer anderen Firma anzuregen.</p> <p>Vorstehende technische Änderungen sind so dem in Betrieb befindlichen Fahrzeugen nur dann anschließend auszuführen, wenn jeweils ein Fahrzeug einer anderen größeren Reparatur unterzogen werden muß. An dem in Auftrag gegebenen 10 Saucer-Fahrzeugen sind die vorstehenden Änderungen so weit als möglich zu berücksichtigen. Da die Hersteller-Firma gelegentlich einer Rücksprache betonte, daß konstruktive Änderungen z.Zt. nicht oder nur für kleinste Änderungen möglich sind, ist bei einer anderen Firma der Versuch zu unternehmen, mindestens</p> <p style="text-align: right;"><u>eines</u></p>
--	--

Kogon continued



Berlin, den 5 Juni 1942  
EINGETRAGENE AUSFERTIGUNG.

3 a (9) Nr. 21/A<sup>2</sup> g.Rs.

**Geheime Reichsache!**

**I. V e r m e r k :**

**Betreff:** Technische Abänderungen an den im Betrieb eingesetzten und an den sich in Herstellung befindlichen Spezialwagen.

Seit Dezember 1941 wurden beispielsweise mit 3 eingesetzten Wagen 97 000 verarbeitet, ohne daß Mängel an den Fahrzeugen auftraten. Die bekannte Explosion in Kulmbach ist als Einzelfall zu bewerten. Ihre Ursache ist auf einen Bedienungsfehler zurückzuführen. Zur Vermeidung von derartigen Unfällen ergingen an die betroffenen Dienststellen besondere Anweisungen. Die Anweisungen wurden so gehalten, daß der Sicherheitsgrad erheblich heraufgesetzt wurde.

Die sonstigen bisher gemachten Erfahrungen lassen folgende technische Abänderungen zweckmäßig erscheinen:

1.) Um ein schnelles Zinströmen des CO unter Vermeidung von Überdrucken zu ermöglichen, sind an der oberen Rückwand zwei offene Schlitze von 10 x 1 cm lichter Weite anzubringen. Dieselben sind außen mit leicht beweglichen Scharnierblechklappen zu versehen, damit ein Ausgleich des evtl. eintretenden Überdruckes selbsttätig erfolgt.

2.) Die Beschichtung der Wagen beträgt normalerweise 9 - 10 pro m<sup>2</sup>. Bei den großräumigen Saure-Spezialwagen ist eine Ausnutzung in dieser Form nicht möglich, weil dadurch zwar keine

eines dieser 10 Fahrzeuge mit allen Neuerungen und Abänderungen, die sich bisher aus der Praxis ergeben, auszustatten. Ich schlage vor, die Firma in Hohenmauth mit der Einleausführung zu beauftragen.

Nach den Umständen ist bei diesem Fahrzeug mit einer späteren Fertigstellung zu rechnen. Es ist dann nicht nur als Muster-, sondern auch als Reserve-Fahrzeug bereitzubehalten bzw. einzusetzen. Bei Bewahrung sind die übrigen Fahrzeuge nacheinander aus dem Betrieb zu ziehen und dem Musterfahrzeug entsprechend umzubauen.

II. Gruppenleiter II D  
H-Obersturmbannführer R e u f

mit der Bitte um Kenntnisnahme und Entscheidung vorgelegt.

*J.D.*  
*J. J. J.*  
*S. J. J.*

Kogon continued

2. From Rückerl 1971, pp. 209-213

- 2 -

keine Überlastung eintritt, jedoch die Gelände-  
 eignigkeit sehr herabgemindert wird. Eine Ver-  
 kleinerung der Lederfläche erscheint notwendig.  
 Sie wird erreicht durch Verkürzung des Auf-  
 beses um ca. 1 m. Vorstehende Schwärzigkeit  
 ist nicht, wie bisher, dadurch abzustellen,  
 daß man die Stückzahl bei der Beschickung ver-  
 mindert. Bei einer Verkleinerung der Stückzahl  
 wird nämlich eine längere Betriebsdauer not-  
 wendig, weil die freien Räume auch mit CO an-  
 gefüllt werden müssen. Dagegen reicht bei  
 einer verkleinerten Lederfläche und vollstän-  
 dig ausgefülltem Laderaum eine erheblich kür-  
 zere Betriebsdauer aus, weil freie Räume feh-  
 len.

In einer Besprechung mit der Herstel-  
 lerkfirma wurde von dieser Seite darauf hinge-  
 wiesen, daß eine Verkürzung des Kastenaufbaues  
 eine ungünstige Gewichtverlagerung nach sich  
 zieht. Es wurde betont, daß eine Überlastung  
 der Vorderachse eintritt. Tatsächlich findet  
 aber ungewollt ein Ausgleich in der Gewicht-  
 verteilung dadurch statt, daß das Ladegut beim  
 Betrieb in dem Streben nach der hinteren Tür  
 immer vorwiegend dort liegt. Hierdurch tritt  
 eine zusätzliche Belastung der Vorderachse  
 nicht ein.

- 3.) Die Verbindungsschleuche zwischen Aus-  
 puff und Wagenkasten des hinteren durch, die  
 sie im Innern durch entfallende Flüssigkeiten  
 zertrümmern werden. Um dieses zu vermeiden, ist  
 der Einflulattuzen nacheinander so zu verlegen, daß  
 eine Einflührung von oben nach unten erfolgt.  
 Dadurch wird ein Einfließen von Flüssigkeit  
 ten verhindert.

- 3 -

- 4.) Um eine handliche Säuberung des Fahr-  
 zeuges vornehmen zu können, ist der Boden in  
 der Mitte mit einer dicht verschließbaren Ab-  
 flüßöffnung zu versehen. Der Abflüßbockel mit  
 etwa 200 bis 300 mm  $\phi$  erhält einen Syphon-  
 krümmer, sodaß dünne Flüssigkeit auch während  
 des Betriebes ablaufen kann. Zur Vermeidung  
 von Verstopfungen ist der Krümmer oben mit  
 einem Sieb zu versehen. Dicker Schmutz kann  
 bei der Reinigung des Wagens durch die grobe  
 Abflüßöffnung fortgespült werden. Der Boden  
 des Fahrzeuges ist zur Abflüßöffnung leicht zu  
 neigen. Hierdurch soll erreicht werden, daß  
 alle Flüssigkeiten unmittelbar zur Mitte ab-  
 fließen. Ein Eindringen der Flüssigkeiten  
 in die Röhren wird somit weitgehend unterbun-  
 den.

- 5.) Die bisher angebrachten Beobachtungs-  
 fenster können entfallen, da sie praktisch  
 nie benutzt werden. Bei der Fertigung weite-  
 rer Fahrzeuge wird durch den Fortfall der  
 Fenster mit Bezug auf die schwierige Anbrin-  
 gung und dichte Abschließung derselben erheb-  
 liche Arbeitszeit eingespart.

- 6.) Die Beleuchtungskörper sind stärker  
 als bisher gegen Zerstörungen zu sichern. Das  
 Eisengitterwerk ist so hoch gewölbt über den  
 Lampen anzubringen, daß eine Beschädigung der  
 Lampenfenster nicht mehr möglich ist. Aus der  
 Praxis wurde vorgeschlagen, die Lampen entfal-  
 len zu lassen, da sie angeblich nie gebraucht  
 werden. Es wurde aber in Erfahrung gebracht,  
 daß beim Schließen der hinteren Tür und somit  
 bei eintrittender Dunkelheit immer ein starkes

- 1 -

Rückert continued (bottom of page 3 cropped due to scanning error)

- 5 -

einmal dieser 10 Fahrzeuge mit allen Neuerungen und Änderungen, die sich bisher aus der Praxis ergeben, auszustatten. Ich schlage vor, die Firma in Hohenmuth mit der Einzelanführung zu beauftragen.

Nach den Umständen ist bei diesem Fahrzeug mit einer späteren Fertigstellung zu rechnen. Es ist dann nicht nur als Muster-, sondern auch als Reserve-Fahrzeug bereitzubehalten bzw. einzusetzen. Bei Beschädigung sind die übrigen Fahrzeuge scheinbar aus dem Betrieb zu ziehen und dem Musterfahrzeug entsprechend umzubauen.

II. Gruppenleiter II D  
H-Oberstabsführer R a u f f

mit der Bitte um Kenntnisnahme und Entscheidung vorgelegt.

*7.4*  
*7.10*  
*Cl. Sch.*

Drängen der Ladung nach der Tür erfolgte. Dieses ist darauf zurückzuführen, daß die Ladung bei eintretender Dunkelheit sich nach dem Licht drängt. Es erscheint das Zinkblech der Tür. Ferner wurde festgestellt, daß der auftretende Lärm wohl mit Bezug auf die Umhüllbarkeit des Dunkelblechs immer dann einsetzt, wenn sich die Türen schließen. Es ist deshalb zweckmäßig, daß die Beleuchtung vor und während der ersten Minuten des Betriebes eingeschaltet wird. Auch ist die Beleuchtung bei Nachtbetrieb und beim Reinigen des Wageninnern von Vorteil.

7.) Um eine schnelle und leichte Entladung des Fahrzeuges zu erreichen, ist ein ausfahrbarer Rest anzubringen. Er ist auf kleinen Rügern in U-Eisen-Schienen zu führen. Das Aus- und Einfahren hat mit einer unter dem Wagen angebrachten Drahtseilzugwinde zu geschehen. Die mit der Anbringung beauftragte Firma hat diese Ausführung wegen Kräfte- und Materialmangel z.Zt. für undurchführbar. Die Ausführung ist bei einer anderen Firma anzusetzen.

Vorstehende technische Änderungen sind an dem im Betrieb befindlichen Fahrzeugen nur dann nachträglich auszuführen, wenn jeweils ein Fahrzeug einer anderen größeren Reparatur unterzogen werden muß. An den im Auftrag gegebenen 10 Saure-Fahrzeugen sind die vorstehenden Änderungen so weit als möglich zu berücksichtigen. Da die Herstellerfirma gelegentlich einer Rücksprache betonte, daß konstruktive Änderungen z.Zt. nicht oder nur für kleinste Änderungen möglich sind, ist bei einer anderen Firma der Versuch zu unternehmen, mindestens

einmal

Rückerl continued

Appendix 6: The Turner Letter

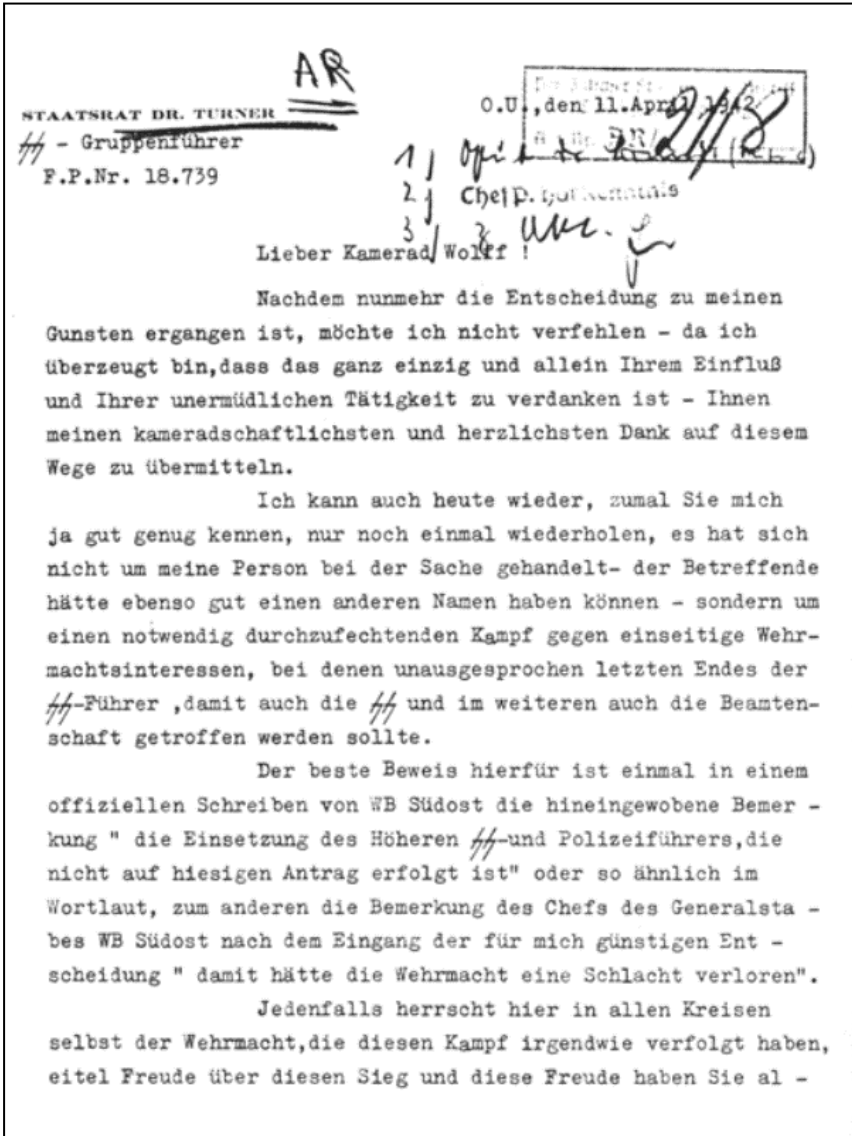

lein ,wie ich glaube,allen diesen Menschen bereitet .  
Dafür meinen Dank !

Darf ich diese Gelegenheit benutzen, um Ihnen anliegend die Abschrift eines Briefes von mir an den Reichsführer vom 15.Januar 1942 zu übersenden, auf den ich bis heute ohne Antwort geblieben bin.Ich möchte nicht erinnern, weil solche Dinge wie ich weiss Zeit brauchen und ich mich nicht für berechtigt halte, den Reichsführer an die Erledigung einer Sache zu erinnern. Immerhin weiss ich,dass Sie für diese Dinge Interesse haben und warum ich Sie jetzt darauf aufmerksam mache, hat einfach seinen Grund darin, dass demnächst diese Frage mehr als akut wird . Schon vor Monaten habe ich alles an Juden im hiesigen Lande greifbare erschossen und sämtliche Judenfrauen und=Kinder in einem Lager konzentrieren lassen und zugleich mit Hilfe des SD einen " Entlausungswagen " angeschafft,der nun in etwa 14 Tagen bis 4 Wochen auch die Räumung des Lagers endgültig durchgeführt haben wird,was allerdings seit Eintreffen von Meysner und Übergabe dieser Lagerdinge an ihn, von ihm weitergeführt worden ist. Dann ist der Augenblick gekommen, in dem die unter der Genfer Konvention im Kriegsgefangenenlager bei .i-lichen jüdischen Offiziere nolens volens hinter die nicht mehr vorhandenen Angehörigen kommen und das dürfte immerhin leicht zu Komplikationen führen .

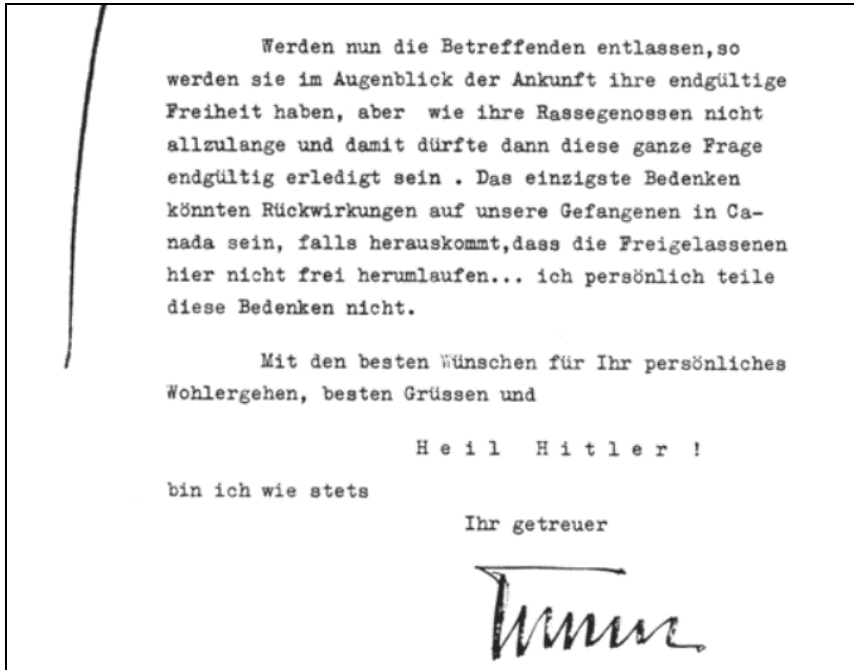

### Translation

Privy Councilor Dr. Turner  
 SS-Major General  
 F.P. Number 18.739

O.U., 11 April 11 1942

Dear Comrade Wolff!

After the decision has now been made in my favor, I don't want to fail – since I am convinced that this is singularly and only thanks to your influence and your tireless activity – to convey to you my most comradely and most heartfelt thanks in this way.

I can also again today, the more so since you know me well enough, only once more repeat that the matter did not have to do with my person – the person concerned could have just as easily had another name – but rather with a necessary battle that had to be fought out against one-sided Wehrmacht interests, by which in the final unspoken result the SS Führer, and therewith also the SS and further also the corps of civil servants would have been affected.

The best proof for this is, on the one hand, a remark woven into an official letter by Military Area Southeast “the appointment of the Higher SS and Police Leader, which did not occur due to the proposal here” or some wording like that, and on the other hand the remark of the Chief of General Staff of Military Area Southeast after receipt of the decision in my favor “herewith the Wehrmacht would have lost a battle.”

In any event, pure joy prevails here about this victory in all circles even of the Wehrmacht who have somehow followed this struggle, and you alone have brought this joy to these people, as I believe. My thanks for that.

May I use this occasion to send you enclosed the duplicate of a letter by me to the Reichsführer of 15 January 1942 to which I have remained without an answer to this day. I don't want to remind, because such things take time as I know and I don't feel entitled to remind the Reichsführer about the settlement of an issue. I know after all that you have an interest for such matters and why I now draw your attention to it has its reason simply in the fact that this question is soon becoming more than critical. Already some months ago, I shot dead all the Jews I could get my hands on in this country, concentrated all the Jewish women and children in a camp and at once with the help of the SD acquired a “delousing van,” which will have accomplished the definitive clearance of the camp in about 14 days to 4 weeks, which, however, was continued by Meyssner since his arrival and the turning over of these camp issues to him. Then the moment has come in which the Jewish officers located in the prisoner of war camp under the Geneva Convention get behind the no longer existing relatives – willingly or not – and that could after all easily lead to complications.

When those affected are being released, they would in the moment of arrival have their final freedom, but like their racial comrades not for very long and with that this entire question should be resolved once and for all. The onliest concern could be repercussions on our prisoners in Canada, if it comes to light that the freed persons do not run around freely here... I personally do not share these concerns.

With the best wishes for your personal well being, best greetings and  
Hail Hitler!

I am as always

your loyal  
(signed Turner)

## Appendix 7: Einsatzgruppen Report February 1942

- 7 -

000159

141

SK 7 b:  
 Pkw Merc. 2,3 Ltr. Pol 71 573  
 " " 1,7 " " 71 079

EK 8:  
 Pkw Opel-Kapitän Pol. 35 881

EK 9:  
 Pkw Wanderer " Pol 46 270

SKM:  
 Pkw Kübel Merc. 3,4 Ltr. Pol 47 817.  
 Ferner wurde der Pkw Merc. 2,3 Ltr. Pol 71 416 dem  
Gruppenstab zugeteilt.

Die am 23. 2. 42 in Smolensk ein- und anwesenden Gaswagen wurden  
 wie folgt verteilt:

EK 8:  
 Lkw Saurer Pol 71 457

EK 9:  
 Lkw Saurer Pol 71 457

Beide Fahrzeuge kamen defekt in Smolensk an und wurden  
 nach Behebung der Defekte dem Einsatzkommando zugeteilt.

Die beiden kleineren Gaswagen werden nach Abschluss des  
 Einsatzes beim EK 8 dem SK 7a und dem SK 7b überwiesen.

Der Bestand an Kfz. ist nach Absetzung der verlorenen z.Zt.  
 folgender:

Stab: (einschl. SKM)

19 Pkw	4 Lkw	3 Sonder-Kfz.	1 Krad
(SKM 5 Pkw und 1 Funkstelle)			

SK 7 a:

19 Pkw	2 Lkw	1 Sanka
(davon 1 Funkstelle)		

Activity and situation report of Einsatzgruppe B, of 1 March 1942, covering the time from 16 to 28 February 1942; here pages 7f.

Der Bundesbeauftragte für die Unterlagen des Staatssicherheitsdienstes der ehemaligen DDR, ZUV 9, vol. 31, pp. 159f.



- 8 -

600100

149

142

SK 7 b:

23 Pkw (davon 1 Funkstelle) 3 Lkw 1 Sanka

EK 8:

35 Pkw 3 Lkw 1 Sanka 1 Gaswagen

EK 9:

36 Pkw (davon 1 Funkstelle) 5 Lkw 1 Gaswagen

Hiervon wurden durch Feindeinwirkung vernichtet: 10 Pkw.Weiterhin wurden stark beschädigt: (Einschl. 4 Beute-Lkw)  
= 5 Lkw und 1 Krad Waffen-.Bei weiteren 7 Pkw, die z.Zt. nicht fahrbereit sind, müssen die Schäden noch festgestellt werden. Es ist jedoch damit zu rechnen, daß mehrere dieser fahrbereit gemacht werden können.

Von den in Mogilew beim EK 8 untergestellten Kfz. sind 1 Pkw und 1 Lkw bereits wieder instandgesetzt worden. Der Pkw wurde nach Molensk überführt, während der Lkw in Mogilew verblieb, da mit diesem noch 2 Pkw, die hier nicht instandgesetzt werden können, nach Warschau transportiert werden sollen. Der Transport wird mit den Kfz. vom EK 8, die ebenfalls in Warschau repariert werden sollen, gemeinsam durchgeführt.

Damit beim wieder einsetzenden Vormarsch hinsichtlich der Besetzung der Kfz. (insbesondere auch der Beute-Kfz.) keine Schwierigkeiten entstehen, ist die Zuweisung von ca. 20 Fahrern erforderlich. Außerdem ist es beim Vormarsch unbedingt notwendig, alle schweren Lkw - wie Werkstattwagen, Omnibus, Gaswagen und Tankwagen - mit 2 Fahrern zu besetzen. Entsprechende Zuweisungsanträge werden gesondert gestellt.

b) Ersatzteile:

Die bereits geschilderten Schwierigkeiten hinsichtlich der Beschaffung von Ersatzteilen bestehen nach wie vor.

Tätigkeitsbericht

der Fahrbereitschaft vom 1. bis 31. Oktober 1942.

**A) Fahrzeugeinsatz (Zusammenfassung)**

Einsatztage im obigen Zeitraum		27	
Fahrzeugeinsätze " "			383
Fahrzeugeinsatz täglich, durchschnittlich	14 LKW		
<u>Insgesamte Fahrten im obigen Zeitraum</u>			
innerhalb des Lagerbereiches		1970	
außerhalb " "		14	
für die Firmen		225	2209
<u>Gefahrene Kilometer</u>			
mit Benzin und Diesel		13974	
" Holzgas		662	
" Treibgas		156	14792
<u>Treibstoffverbrauch im obigen Zeitraum</u>			
Benzin		1594 l	
Dieselmotorkraftstoff		5119 kg	6713

**B) Detaillierter Fahrzeugeinsatz innerhalb des Lagerbereiches**

Lfd. Nr.	Fahrzeugeinsatz für K.G.L.	Barackenteile	
1			323
"	sonstiges Baumaterial	994 =	1317
2	Babitz und Budy Holz für Feldscheu- benbau und Kies für Fundamente		182
3	für Babitz - Zimmerei (Abbruch, Holz)		14
4	" Bauhof Zimmerei Holz		29
5	" Bauleitungsbaracke, Koks und die Entwesung		16
6	" Bobrek		11
7	" Broschkowitz		23
8	" Fernheizkanal, Sand		13
9	" Gärtnerei Bauleitung, Humus		23
10	" Gemeinschaftslager, Baumaterial und für die Entlausung		47
11	" Haus Nr. 35, Baumaterial und Brunnenrohre		18
12	" Haus Nr. 114, "		2
13	" " " 148, "		3
		Übertrag	1698

- 2 -

Activity report of the Auschwitz motor pool for October 1942;  
Rossiiskii Gosudarstvennii Vojennii Archiv (Russian national war ar-  
chives), Moscow, ref. 502-1-181, p. 246.

## Appendix 8: Special Vehicles of the German Army

The technical data given for the two decontamination vehicles were taken from a German wartime brochure in the author's possession entitled *Bildermappe. Eingeführte Waffen und Geräte* (Picture Folder. Introduced Weapons and Devices), which contained a collection of numerous German army vehicles and their technical data.

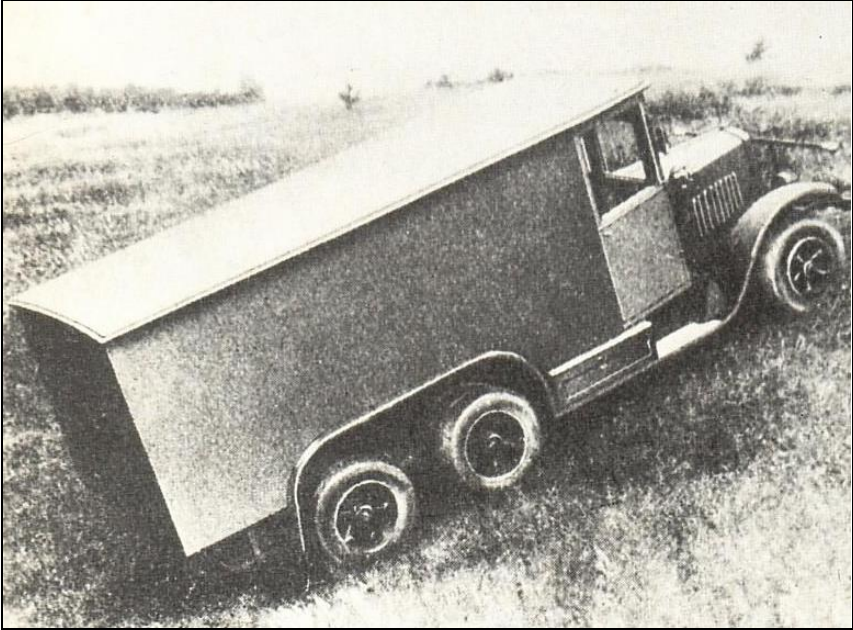

**Illustration 22:** Krupp L3H63 (picture from Milsom 1975, p. 104). Milsom does not give any indication as to the Sd.-Kfz. number assigned to this vehicle nor about its purpose or technical data. Since the vehicle did not seem to have had any special equipment, this might just have been a closed transportation van.

---

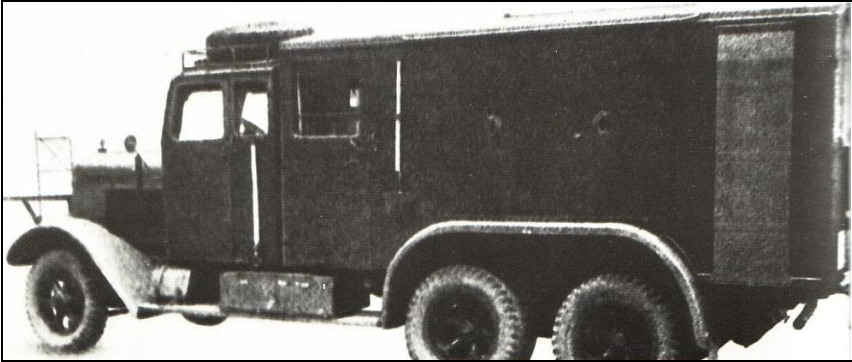

**Illustration 23:** Sd.-Kfz 92, personnel decontamination vehicle, Henschel 33G1 (picture from Milsom 1975, p. 144).

Purpose: decontamination of personnel and of heavy gas protection clothing used by the “fog units” [similar to ABC defense units]

Technical data: chassis: medium-size off-road capable 3 t truck. Warm water generation with a water brake driven by the engine with a performance of 44,000 kcal/h to heat the decontamination tub for heavy gas protection clothing and for warm water for two showers. Total weight: 9.3 tons.

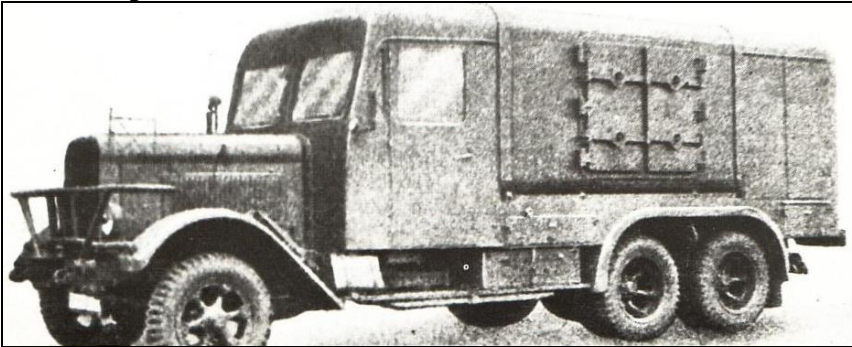

**Illustration 24:** Sd.-Kfz. 93, clothing decontamination vehicle, Henschel 33G1 (picture from Milsom 1975, p. 145)

Purpose: Assigned to the troop decontamination details for decontaminating uniforms, leather equipment, and gas masks with hot air and steam.

Technical data: chassis: medium-size off-road capable 3 t truck. Steam of 0.2 bar, 50 kg/h; air of 120°C, 3,600 m<sup>3</sup>/h; 2 chambers for 30 uniforms each of 2 m<sup>3</sup> volume each; Duration of decontamination: 1½ hours for uniforms (combined steam-hot air process); ½ hour for leather equipment (hot air process). Total weight: 9.7 tons.

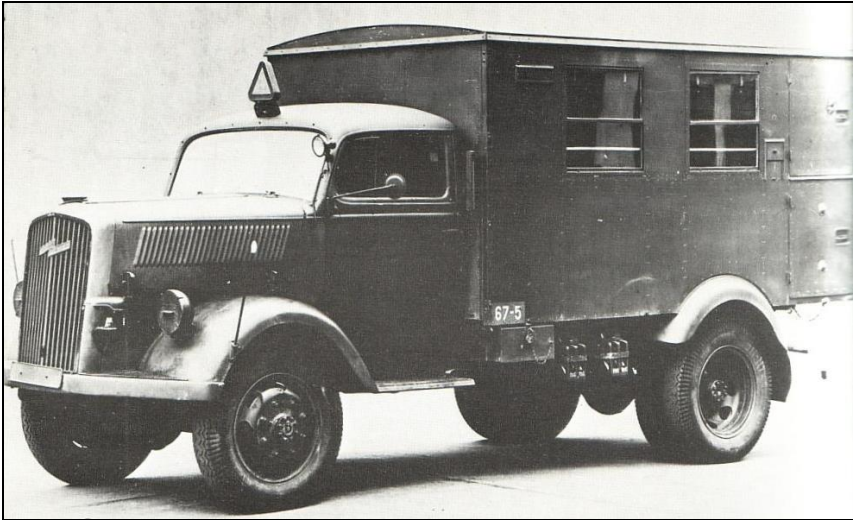

**Illustration 25:** Opel Blitz, A-Type (=all wheel drive), 3 tons. Together with the S-Type (standard drive), almost 100,000 of this truck were delivered to the Wehrmacht during World War II, some built by Daimler Benz, Borgward, and Klöckner-Deutz under license. It came with a broad range of coachworks. Hence, there was nothing special about this truck at all. Engine: gasoline, 3,600 ccm, 6 cyl., 68 HP. With such an engine, its exhaust gases were lethal. (Picture from Mil-som 1975, p. 174)

---

## Appendix 9: Interrogation Protocol of Witness Falborski

See my comments in chapter 3.6.2.3.

66, 4e comar., 10 sept. 1980

28

Pr.akt .....

PROTOKOL PRZESŁUCHANIA ŚWIADKA.

Data ..... 11. sierpnia ..... 1945 r. w ..... Kole .....

Sędzia Sledczy ..... Rejonu Sądu Okręgowego w ..... Łodzi .....

w osobie Sędziego .....  
 w udziale Protokolanta.....  
 w obecności stron.....

przesłuchał ninieży wymienionego w charakterze - świadka bez przy-  
 stęgi. Po uprzedzeniu świadka o odpowiedzialności karnej za fał-  
 szywe zeznania i o treści art. 140 k.p.k. - oraz o znaczeniu przy-  
 stęgi, Sędzia odebrał od niego powyższe oświadczenie.....  
 k.p.k. poezem świadek zeznał co następuje:

Imię i nazwisko..... Bronisław Falborski .....

Wiek..... 35 lat .....

Imiona rodziców..... NN. Małdalena .....

Miejsce zamieszkania..... Kole .....

Zajęcie..... siofer .....

Wyznanie..... Kościół Katolicki .....

Karalność..... nie karany .....

Stosunek do stron.....

W czasie tkupacji niemieckiej pracowałem w firmie "Kraft" w Kole (przy ul. Asnyka) jako mechanik - Pracowałem w wspomnianej firmie od Kwiatnia 1942 do 1943r. - Dat dokładnie nie pamiętam - Firma nasza reperowała samochody Sonder Komando SS Culmbach i raz skierowano do naprawy auto które służyło do zatrucia gazami. Kiedy to miało miejsce - dokładnie określić nie potrafię Sądę, że było to ~~latem 1942r.~~ Auto mogło mieć około 2m 50cm. wysokości. Długość jego wynosiła około 6 metr., wysokość zaś prawdopodobnie około 2m 50 cm. . Auto było koloru czarnego i miało kształt skrzyni. Dach był prawie płaski i stykał się z ścianami nieznacznie pod kątem prostym. Obity on był szkieletem blacha - nie jestem jednak tego pewien. Silnika nie oglądałem. Nie było zawieszona "marki" samochodu. Drzwi samochodu były zamknięte na rygiel i klucz. Pilnowało samochodu kilku żandarmer i niepozwolili nam przyglądać się konstrukcji auta. - Nie zwróciliśmy uwagi czy w "szoferce" były zamontowane znaki gazowe. Czym miał samochód numer rejestracyjny -nie pamiętam

Powierzono mi reperaturę. Reparacja polegała na zamianie pakunku pomiędzy częścią elastyczną rury wydechowej a częścią prowadzącą do wnętrza samochodu. Wyjaśniam że rura wydechowa nie była jednolita w całej swej długości, tak, jak w każdym normalnym samochodzie, tylko składała się z trzech odcinków, przyczym odcinek środkowy był elastyczny, jak was hydrauliczny. Wspomniany środkowy odcinek rury wydechowej można było biał istryc z odcinkiem rury wystającej z podłogi samochodu i wówczas gas ~~zaczynała~~ spalinowy wchodził do środka samochodu - bądź też można było go laosyc z końcowym odcinkiem rury wydechowej i wówczas opływająca rura wydechowa funkcjonowała jak w każdym normalnym samochodzie. Gdy auto skierowano do reperatury rura wydechowa było włączona do wnętrza wozu, jednak pakunek pomiędzy dwoma łącznikami (flansami) zniżył się i polecono mi zamienić wspomniany pakunek. Zamieniam pakunek - zakładając pakunek atestowy i łączniki smoczawien caterak srubkami. - Związkiem równocześnie sporządzony szkic rury wydechowej - z uwzględnieniem połączenia rury wydechowej i rury prowadzącej do wnętrza samochodu. Robota trwała ok. 200 godzin, przyczym stale mi pomagało. W tym czasie w warsztacie pracowali: Zygmunt Roesak, Zbigniew Dudziński (oba w wojsku) Szablewski Marjan - pracuje w Kutnie na kolei, Janowski, Junkien, Lewandowski - (adres i adresow nie mam) oraz Zenon Rosa (obecnie pracuje na poczcie). Poza tym jednym wypadkiem więcej przy mnie nie było reperatury samochodu. Sondaż Komando SS Culańców służył do zatrważenia gazał. - Bezpośrednio przed objęciem posady w warsztacie "Kraft" byłam szoferem u nadleśniczego Mała. Często w związku z tym bywałem w lesie Chełmińskim - widziałem wielokrotnie w tym okresie czasu auta jadące do lasu chełmińskiego i z powrotem. Były to auta takie same jak te które później reparowałem w warsztacie "Kraft". Odniosłem wrażenie, że jadąc tylko dwa auta jeźniłowej wielkości - zwykłe miały się w drodze. Jak długo trwał kurs takiego auta nie potrafię dokładnie powiedzieć. Może trwał to pół godziny - może godzinę. Widziałem trzykrotnie auto przetrzebione z wozu nablowego które obecnie znajduje się na podwórku dawnej Firy. "Ostrowskiego" - Na widziałem ten samochód już na terenie lasu - drugi raz na drodze a trzeci raz wyjeżdżający z podwórka pałacowego w Chełmie. - Samochód ten widziałem w odstępach kilku dniowych. - Było to na wiosnę 1943r. - Ostatnio samochód ten oglądałem na podwórku Febr. Ostrowskiego i jestem absolutnie pewny że jest to ten same auto (rozmiar - kształt - barwa)

Właśnie przedmiotem zaliczenia i po odurzeniu  
 podpisano nadp. ~~urządzenia~~ ~~nie~~ ~~...~~  
 Jablowski, Bonni, ~~...~~ ~~...~~  
 1943 rok, ~~...~~



## Translation

### Interrogation protocol of the witness

On 11 June 1945 Władysław BEDNARZ, Investigating Judge at section IV of the Łódź District Court, interrogated the below witness, who was left unsworn. After the witness had been informed that giving a false testimony is an offense, he declared the following:

Name and First name: Bronisław FALBORSKI

Age: 35 years

Names of parents: [father] unknown, [mother] Magdalena

Residence: Koło

Profession: Driver

Religion: Roman Catholic

Previous convictions: none

### Declaration by the witness

During the German occupation I worked as a mechanic for the German company “KRAFT” in Koło, Asnyk street. I worked for said company from April 1942 to 1943. I don’t remember the exact dates. Our company repaired vehicles of the SS *Sonderkommando* from Culmhof. Once I was ordered to repair a vehicle which served to poison with gases. I cannot exactly remember when this happened. I think that it was in the summer of 1942. The vehicle was roughly 2.50 m high. Its length was 6 m, but its height [width] probably 2.50 m. The vehicle’s color was black and had the shape of a box. The roof was flat and rectangular to its walls. I believe that it was lined with sheet metal, but I am not certain about it. I did not look at the engine, and I did not pay attention to the make of the vehicle. The vehicle’s doors could be locked with latch and keys. The vehicle was guarded by several police men who did not allow me to investigate its design. I did not pay attention to whether a gas mask hung next to the driver’s seat. I cannot recall whether the vehicle had a registration number. I was entrusted with the repair. It consisted of replacing a part between the elastic part of the exhaust pipe and the part which led into the vehicle’s interior. I clarify that the exhaust pipe did not consist of one piece as in normal vehicles, but of three parts, where the middle part was elastic like a hose. Said middle part could either be connected to a pipe located in the floor of the vehicle – with the result that the exhaust gases flowed into the vehicle’s in-



terior – or to the rear part of the exhaust pipe; in that case the exhaust gases flowed into the open like with a normal vehicle. When the vehicle was turned in for repairs, the middle part of the pipe was connected with the interior of the vehicle, but the part between these two parts was worn, and I was ordered to replace it. I replaced it by mounting a new part made of asbestos fixed with four screws. I include a drawing of the exhaust pipe which I have made which shows the connection between the exhaust pipe and the vehicle's interior. This work took roughly half an hour, while I was constantly goaded to hurry up. At that time the following persons worked in that work shop: Zygmunt Roszak, Zbigniew Dudzinski – both are in the army [today] –, Szablewski Marian, who today works in Kutno with the railway, Jankowski, Junkiert, and Lewandowski, whose first names and addresses I cannot remember, as well as finally Zenon Rosa, who currently works for the mail services. Apart from this individual case there were no repair works on a vehicle of the Special Command SS [K]ulmhof serving to poison with gas.

Immediately before my employment at the “Kraft” workshop I had been driver for the forester Maj. In that connection I was frequently in the forest of Chełmno. In that period of time I frequently saw vehicles driving into the Chełmno forest and back. These were vehicles like those which I repaired later on in the “Kraft” workshop. I had the impression that there were only two vehicles of the same size which encountered each other on their way. I cannot say anymore with exactness how long a journey of such a vehicle lasted. Maybe it lasted half an hour to an hour. Three times I saw a converted moving truck van which is currently in the courtyard of the former “Ostrowski” company. Once I had already seen this vehicle in the forest, the second time on the road and the third time when it was just coming out of the courtyard of the Chełmno castle. This was in spring 1943. I saw this vehicle repeatedly with a gap of several days. Recently I saw this truck in the courtyard of the Ostrowski factory, and I am absolutely certain that it is the same vehicle (size – shape – color).

This concludes the interrogation protocol. Signed after reading out.

(signed) Falborski Bronisław

Władysław Bednarz

Investigating Judge

Drawing included in Falborski's affidavit

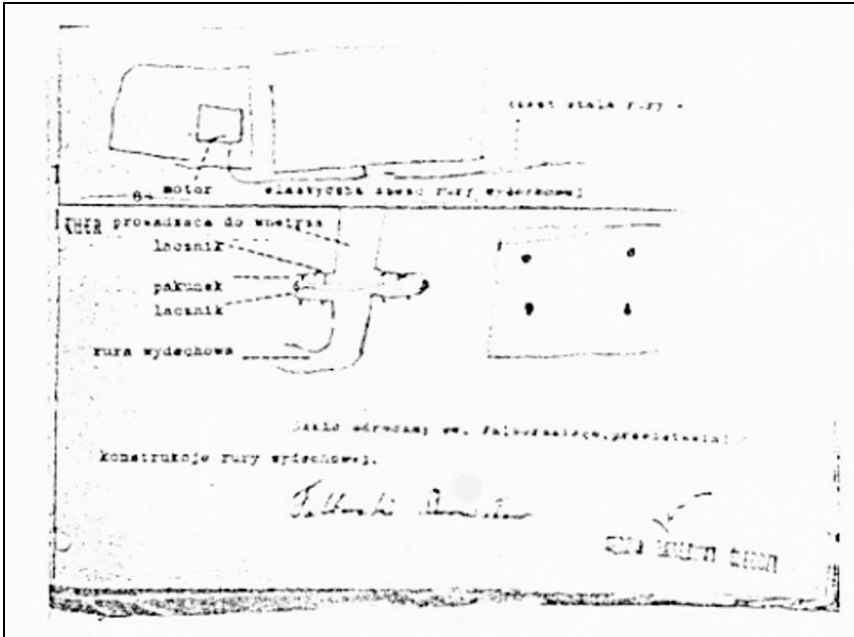

Translation of captions:

<i>Polish</i>	<i>English</i>
Elastyczna czesc rury wydechowej	Flexible part of exhaust pipe
Czesc satla rury wydechowej	Sturdy part of exhaust pipe
Rura prowadzaca do wnetrza	Pipe leading to outside
Lacznik	Connection
Pakunek	Device
Rura wydechowa	Exhaust pipe

## Appendix 10: Correspondence

## Letter on the "Gas Vans" of Mauthausen

MAISON DES MISSIONNAIRES  
42, RUE DE GRENELLE  
75007 PARIS  
TÉL. 548.15.44

Le 4 mai 1987

Cher Monsieur,

Votre obstination me laisse perplexe... Vous me dites que je ne peux pas avoir vu la cheminée du crématoire de Mauthausen cracher le feu ; si j'ai écrit cela, c'est parce que effectivement, avec mes camarades, notamment Claude Lemaitre, Sénateur- Maire de Châteaufort sur Loire, Jean Biondi, Vice-Président du parti socialiste avant la guerre, et ensuite Ministre de la Fonction Publique, Jean Bernier, etc... nous gardons le souvenir ineffaçable de cette nuit où nous avons vu horrifiés les flamèches lumineuses sortant de la cheminée du crématoire et rougeoyant le ciel. C'est un fait dont nous pouvons témoigner dans le respect le plus total de la vérité. De quel droit pouvez-vous le contester ?

Quant au vernichtungslager, s'il est vrai que ma secrétaire a oublié un "s", cette expression faisait partie du vocabulaire officiel du camp. C'est Himmler, lui même, qui avait réparti les camps en quatre catégories dont la dernière était celle des irrécupérables destinés à être purement et simplement supprimés.

Quant aux véhicules à gaz, il y en a eu plusieurs catégories. Ce qui est certain, c'est que ceux qui étaient embarqués vivants au départ de Mauthausen, n'étaient plus que des cadavres à l'arrivée, soit à Günsen, soit à Hartheim .

Ce qui m'étonne, c'est la confiance absolue que vous accordez aux dires de Rassinier, mais que vous contestez les innombrables témoignages qui le contredisent.

Veillez croire, cher Monsieur, à mes sentiments les plus cordialement dévoués.

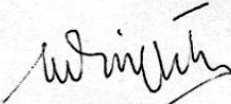
  
Michel RIQUIER s.j.

## Translation and Comments by P. Marais

4 May 1987

Dear Sir,

Your obstinacy leaves me perplexed... You tell me that I cannot have seen flames shooting out of the chimney of the crematory in Mauthausen. If I wrote this, then I did so because effectively, together with my comrades, notably Claude Lemaître, Senator and Mayor of Châteauneuf sur Loire, Jean Biondi, vice president of the Socialist party before the war and later minister for public services, Jean Bernier, etc.... we keep the ineffaceable memory of that night when we saw with horror the bright flames coming from the crematory chimney which reddened the sky. This is a fact to which we can attest with all due respect for the total truth. With what right can you contest this?

Regarding the *Vernichtungslager*, even if my secretary forgot an s, the expression was part of the official camp vocabulary. Himmler himself has divided the camps into four categories, the last of which was destined for the hopeless cases who had to be liquidated, purely and simply.

Regarding the gas vans, there were several categories. What is certain is that those who entered them in Mauthausen, arrived as mere corpses in Gunsen [sic] or in Hartheim.

What astounds me is the confidence you have in the Rassinier's claims, but that you contest the innumerable witness statements contradicting him.

With my best regards

Father Michel RIQUET

Comments by Pierre Marais

During an exchange of letters with pastor Riquet [see previous page], a former inmate of the concentration camp Mauthausen who had published an article in the Paris daily *Le Monde* on 5 October 1986, he sent me a publication about the problem of the gas vans. It is a special reprint of the numbers 123 and 124 of *Le Monde juif*, the periodical of the Centre de documentation juive contemporaine (Jewish Contemporary Documentation Center) located in Paris, which had been deposited

in the first trimester of 1987 “as legal evidence.” Chapter III of this publication bears the title “Assassinats par gaz dans des véhicules spécialement aménagés (*Sonderwagen*)” (gas murders in especially equipped vehicles). On the one hand it is a mere summary of the arguments as published in the anthology *Les Chambres à gaz, secret d’État* (the French edition of *Nazi Mass Murder*), but on the other hand it contains hitherto unpublished details, which appear to indicate that the author, Pierre-Serge Choumoff, who had written the chapter on Mauthausen in said anthology, managed to obtain new information.

First of all I need to emphasize that Choumoff translated the German term “*Sonderwagen*” erroneously as “camion spécialement aménagé” (especially equipped van), which gives the impression that the German prefix “*Sonder-*” gives the term a suspicious meaning. In the caption of Choumoff’s illustration 4 (p. 40) “*Sonderwagen*” is even shamelessly translated as “gas van.”<sup>128</sup>

Choumoff distinguishes between two types of allegedly used “gas vans” (p. 37): “exhaust gas vehicles” (sic) and “gas vans operated with Zyklon B.” I will not dwell on these definitions, which make no sense from a technical point of view.

When describing the vehicles of the first category, the author quotes court verdicts, confessions and other witness statements, and he names the following decisive feature of these “gas vans” (p. 35):

*“It was a hermetically closed van, in whose interior exhaust gases, but certainly also other gases were piped.”*

So out of nowhere we are told about the existence of “multi-gas vans”! Choumoff writes (*ibid.*):

*“Soon [this van] drove around within the [Mauthausen] camp [...], until its human load was no longer alive, upon which it drove this load to the crematory.”*

This latter claim gives rise to two questions:

a) What was the reason to drive the van around within (or maybe also outside of) the camp – allegedly to generate the needed exhaust gas to kill the victims – if the same volume could have been produced just as efficiently – or maybe even more efficiently – with a stationary van (provided it had a gasoline engine), which would also have saved precious fuel?

---

<sup>128</sup> Kogon *et al.* (1984, p. 79) mistranslated the term “*Der S-Wagen*” as “*Le camion à gaz*” (the gas van) when quoting document 501-PS. If that isn’t a forgery, what is?

b) How could this “driving around within the camp,” which must have attracted the inmate’s attention, be reconciled with the repeatedly claimed secret nature of these extermination activities?

Choumoff claims furthermore that these “especially equipped vans” gassed their victims “during a ride of some 5 km between Mauthausen and Gusen.” This implies that those vans could safely operate for a considerable span of time (at least the time it takes to drive 5 km, that is, 8 minutes or more) while their exhaust pipe was connected to a hermetically sealed cargo box – which I dispute once more emphatically. Moreover we are told – and not for the first time – that this van was indeed a “coach” (p. 37).

[*Comments by the present author:* In order to emphasize the absurdity of these Mauthausen gas van claims, permit me to quote from a “primary” source instead of relying on Choumoff. It is a list compiled in 1945 by a former inmate clerk of the Mauthausen camp, Ernst Martin:<sup>129</sup>

*“Gas auto*

*An inmate transport car was equipped in a way that ‘Zyklon B’ could also[!] be introduced. The car loaded inmates in Mauthausen, gassed them during transit, unloaded them at the crematorium in Gusen and on the way back loaded inmates in Gusen, gassed them during transit and brought them to the crematorium in Mauthausen.”*

Hence it was a true gassing merry-go-round, wasting fuel along the way – while there was allegedly a stationary Zyklon B gas chamber in Mauthausen all along.

Whereas the witnesses quoted earlier in the present study claimed that the “gas vans” were either a Saurer, a Diamond, an Opel, or a Renault truck, Choumoff presents us a “witness” who “believes that the vehicle was a Mercedes [...] of one and a half or two tons” (p. 38). Considering the fact that this witness was actually the head of the transport department, he had to know it. However, if assuming an average weight of 60 kg for each victim, a maximum load of two tons would have allowed only up to 32 victims (plus the driver) to enter this van, which is in conflict with all witness statements.

---

<sup>129</sup> “Aufstellung über die Art der Ermordung von Häftlingen im K.L. Mauthausen” by Ernst Martin, a former inmate clerk, dated 8 May 1945, Archiv Museum Mauthausen, ref. DÖW 2721; Klamper 1991, p. 33.

Anyway, with this new make and model we truly have an astounding variety of engines and chassis allegedly used. This did most certainly not facilitate the task of the company which had to custom-tailor the “hermetically sealed cargo box” and thusly turn innocuous vehicles into “especially equipped vans”! SA]

At its end Choumoff’s paper contains a gem which I will not withhold from the reader:

*“I know – because I have heard it –, that gas vans existed back then and how they operated.”*

The decisive point here is that Choumoff’s description of the way these “gas vans” allegedly operated is so rudimentary and yet at once expressed with such resolve that it is impossible to take this assertion at face value. At the end of the day, Choumoff merely repeats a rumor: “because I have heard it,” and that’s probably the essence of his essay.

In connection with his statements about the “exhaust gas vehicles” (p. 39) we learn about “the declaration of a witness” talking “about a *hermetically closed vehicle* [...], a van [...] equipped in such a way that its exhaust gases could be split. One part was piped into the van’s interior, where the inmates were.” Now this is much more interesting:

When first turning to the issue of gas vans, I asked how an engine of a vehicle could operate, if its exhaust gases were piped into an *enclosed* cargo box. This peculiarity runs like a red thread through all descriptions of these vehicles, and I posit that a manual or automatic device must have existed within the exhaust system permitting the release of some of the exhaust gases directly to the exterior. Although such a device would have prevented a pressure build-up inside the cargo box and thus its leakage or destruction, it is questionable whether enough gas would have entered the cargo box under such circumstances to affect a swift asphyxiation. This would have been possible only, if the allegedly “hermetically sealed” cargo box was exactly *not* sealed but rather sported some opening(s) through which the gas could have escaped in order that the cargo box fulfills the role of the muffler. (In this context I remind the reader of the logic underlying the first change requested by the Just document.) However, if assuming that such a device to split the exhaust gases was indeed present in those vehicles, and when considering the temperatures and the corrosive nature of the exhaust gases, then the manufacture of such a device would have required the use of special stainless steel, which was rare and expensive in Germany at that time.

Just as no reference can be found to an extant “gas van” in the pertinent literature, no indication exists in any publication that such a device has ever been found. The investigation of such a van would have made conclusions possible regarding the reality of these “murder vans” as well as their operational mode. Instead we are being fobbed off with vague, imprecise declarations which do not stand up to scrutiny, and we are served a hodge-podge of witness statements whose improbability inevitable have to puzzle us.

For the second category of vehicles mentioned by Choumoff, the “gas vans operated with Zyklon B,” the difficulties with the engine do not apply, since here the exhaust gases would have been emitted normally. As a matter of fact, it can be stated with certainty that such “gas vans” did indeed exist, but merely as disinfestation vans, as I have described in chapter 2.3.

This leads us to the more general question of “Zyklon B gas chambers,” which isn’t the topic of this study, though. Yet we cannot but indicate that Choumoff describes the technique to insert the gas into the cargo box only very cursorily:

*“The gas was [...] thrown into the interior of the vans from the driver’s cabin during transit.”* (p. 39)

*“The conversion [of a police van into a gassing van] consisted mainly of sealing the interior of the van.”* (p. 42)

*“A tin container containing the Zyklon-B gas was thrown in during transit from the driver’s cabin.”* (*Ibid.*)

[Comments by the present author: Imagine the scene: two SS men sit on the front seat of the truck. One of them wants to open a Zyklon B can, for which a massive can-opener has to be hit with a hammer. However, in order not to poison themselves, both SS men have to don gas masks at first. Since that cannot be done while driving, they have to stop in order to don the masks. Once properly protected, the two continue their journey. However, since the gas mask severely restricts the driver’s field of vision – not to mention steamy glasses – the truck is at a high risk of having an accident. Next the co-driver opens the can. While the truck lumbers along, driven by a half-blind driver around corners and through potholes, how many Zyklon B pellets will the co-driver spill into the driver’s cabin in the process? Then he opens the window to the back of the truck and tries to pour in the poison. How much of it will the inmates throw right back at him? And if they stand cram-packed right up to the window: how is the co-driver going to get



that stuff into the compartment in between those intended victims in the first place? Moreover, how is he going to close the window, if the victims start fighting for their lives? And finally, what if one of the victims close to the window managed to carry some hard object with him, like a stone, and uses it to break the window?

I think that this little excursion suffices to expose the utter absurdity of this claim about Zyklon B gassings during transit, initiated from the driver's cabin. No sane person would ever have tried this. SA]

To top it off, we are also told that this vehicle, a so-called “*grüne Minna*” (German prisoner transport vehicle) “was conducted by the camp commander personally most of the time” (*ibid.*).

[*Comments by the present author:* Sure, the boss of a 50,000 person enterprise personally drives a prison transport van remodeled to kill people. If that doesn't make the alert reader realize that we are dealing with pure atrocity propaganda, what will? SA]

It goes without saying that the author doesn't utter a word about the security measures necessary when dealing with hydrogen cyanide – ventilation, neutralizing of the gas, touching the victims etc. (The interested reader may consult material about U.S. execution gas chambers in order to find out, how difficult it is to gas one single person (Leuchter/Faurisson/Rudolf 2011). According to Choumoff the operation is said to have been a cakewalk.

Hence this work does not improve our knowledge about the matter at all. The boastful declamations with which the editor's introduction is riddled<sup>130</sup> – “collective work of truth,” “helping the truth about certain points to prevail [...]. The goal is accomplished,” “The facts are recounted, undeniable, definitive,” “These are not only veracious but also true documents” (sic) – cannot placate my skepticism.

We know how these almost lyrical assertions are substantiated in the case of the “gas vans.” Let me quote a last example of the method with which the author wants to help the truth to prevail:

*“The determined anomalies do indeed prove [...] that the eighty cases of death, which are said to have been caused by ‘lung tuberculosis,’ in reality were probably murders in a gas van.”*

Any comment is superfluous.

I had asked pastor Riquet to forward a request to the author of this paper asking him to explain the operational mode of the “gas vans” al-

---

<sup>130</sup> Roger Heim is the editor of this tome.

legedly deployed at Mauthausen. I did not receive a response. What does the clergyman think about it? In his letter to me of 4 May 1987 he wrote:

*“Regarding the gas vans, there were several categories. What is certain is that those who entered them in Mauthausen, arrived as mere corpses in Gussen [sic] or in Hartheim.”*

Fact is that pastor Riquet doesn't know much that is certain about these homicidal vans which were allegedly deployed in the camp where he was interned. One can of course assume that he is not a technician, in contrast to Mr. Choumoff.

[Comments by the present author: Finally, this raises the question: Why were “gas vans” deployed at the Mauthausen camp to begin with, if, as orthodox historians claim, there was also a Zyklon B “gas chamber”? SA]

## Letter by Mathias Beer to Pierre Marais

Mathias Beer  
 Stockheimerstraße 25  
 7000 Stuttgart 40

Stuttgart, den 20.11.1987

Bezug: Ihr Schreiben vom 30. Oktober 1987  
 Betr.: Gaswagen-Komplex

Herrn  
 Pierre Marais  
 Rue de la Poste  
 St-Laurent de la Prée  
 F-17450 Fouras

Sehr geehrter Herr Marais,

haben Sie herzlichen Dank für Ihr Schreiben vom 30. Oktober 1987, in dem Sie Ihr Interesse an meinen Ausführungen über die Entwicklung der Gaswagen, ganz besonders aber an Fragen, die ich wegen meiner Fragestellung entweder nicht oder weniger explizit angesprochen habe, bekunden.

Meiner Antwort auf die einzelnen von Ihnen gestellten Fragen möchte ich einige grundsätzliche Bemerkungen zu meinem Aufsatz vorausschicken. Mein Anliegen war es, einen bis dahin wenig und nicht in allen Details bekannten Vorgang der nationalsozialistischen Massentötung zu erhellen. Dabei ist es mir gelungen über die Erkenntnisse, die die einzelnen Strafverfahren geliefert haben, wesentlich hinauszugehen. Sie beziehen sich auf: die Verbindung zwischen Euthanasie und Gaswagen-Aktion, die Befehlswege bei der Entwicklung der Gaswagen, die genaue zeitliche Abfolge der Ereignisse, die daran beteiligten Personen und Institutionen, die Zahl der Gaswagen bis Mitte 1942, die beiden Serien von Gaswagen und die Gaswagen als Bindeglied zwischen Euthanasie und der Tötung durch Giftgas in den Tötungslagern. Zu diesen Ergebnissen bin ich auf der Grundlage von Quellen und Zeugenaussagen gekommen, die, und das möchte ich unterstreichen, einer eingehenden Quellenkritik und Gegenüberstellung - Verfahren, das bei Historikern üblich ist - unterzogen wurden.

Nun zu Ihren Fragen.

1. Ihre Beschreibung trifft nur auf die Gaswagen der "zweiten Serie" zu, die Saurer-Fahrzeuge, denn wie ich feststellen konnte (vgl. den Aufsatz S.413f.) wurden 1941 nur kleine Fahrzeuge hergestellt. Außerdem war der ursprüngliche Saurer-Wagen 5800 mm lang und die Zahl der pro Einsatz darin vergasteten Personen nicht "ca. 50", sondern zwischen 80 und 100 Personen. Im Aktenvermerk vom 5. Juni 1942, der Ihnen nicht unbekannt ist, ist von 9 bis 10 Personen pro m<sup>2</sup> die Rede.  
Das Problem des großen Drucks, der in den Kastenaufbauten ent-

- 2 -

stand, scheint den an der Entwicklung und beim Einsatz der Gaswagen beteiligten Personen nicht fremd gewesen zu sein. Dafür sprechen die des öfteren vorgenommenen Messungen und der schon erwähnte Aktenvermerk vom 5. Juni 1942. Darin heißt es: "Die bekannte Explosion in Kulmhof ist als Einzelfall zu bewerten. Ihre Ursache ist auf einen Bedienungsfehler zurückzuführen." Diese Explosion und ihre Folgen wird auch von mehreren Zeugen bestätigt. Darüber hinaus wird in dem Aktenvermerk vom 23. Juni 1942 folgendes aufgeführt: "Die durch Schieber verdeckten Öffnungen an den hinteren Türen fallen fort und sind durch offene Schlitze von 100 x 10 mm in der oberen Rückwand (nicht Tür) zu ersetzen. Sie sind außen mit leicht beweglichen Schanierblechkappen zu verdecken." An den Wagen waren demnach einfache "Überdruckventile" angebracht, die jetzt auf Grund der praktischen Erfahrung verbessert werden sollten. (Aktenvermerk vom 23. Juni 1942, Bundesarchiv Koblenz, Sign. R 58/871).

2. Es wäre nicht überraschend, wenn nach dem Krieg keine Gaswagen gefunden worden wären, denn die Gaswagen wurden, wie alle sonstigen Spuren, die die Vernichtung von Menschen hinterlassen hatte, so gut wie es eben in Eile ging, beseitigt. Aber von Gaswagen besitzen wir nicht nur Photos, die von polnischen Behörden nach dem Krieg angefertigt wurden (Archiv in Warschau und Yad Vashem Archives in Jerusalem), sondern ein Gaswagen steht meinen Informationen nach heute in Konin (Polen) als Denkmal zur Erinnerung an die Opfer.

3. und 4. Natürlich sind Unterschiede in der Terminologie der beiden von Ihnen angesprochenen Dokumenten festzustellen, doch ergeben sich, wie ein Vergleich mit den anderen erhalten-gebliebenen Dokumenten zeigt, daraus noch keine "Unwahrscheinlichkeiten".

In der Hoffnung, Ihnen Ihre Fragen zufriedenstellend beantwortet zu haben, verbleibe ich mit besten Grüßen

*Mathias Rée*

## Translation and Comments by P. Marais

(Letterhead omitted)

Re.: Topic of Gas Vans

[...]

Dear Mr. Marais,

Thank you very much for your letter of 30 October 1987, in which you evince your interest in my elaborations on the development of gas vans, and especially in questions which I did either not at all or hardly explicitly address due to my approach.

Before answering the individual questions you posed, I want to make a few fundamental remarks about my essay. My intention was to elucidate a course of events of National Socialist mass killings which so far has not been known in all its details. By so doing I manage to go beyond the insights yielded by the individual penal trials. They relate to: the connection between euthanasia and gas vans, the chain of command during the development of the gas vans, the exact temporal sequence of events, the persons and institutions involved, the number of gas vans in the middle of 1942, the two series of gas vans, and the gas vans as link between euthanasia and the killing with poisonous gas in the death camps. I arrived at these results on the basis of documents *and* witness statements, which, and I want to emphasize this, were subjected to thorough source criticism and juxtaposition – procedures which are common among historians.

Now to your questions.

1. Your description is valid only for the “second series” of gas vans, the Saurer vehicles, because I managed to establish (see my paper pp. 413f.) that in 1941 only small vehicles were built. Apart, the original Saurer vehicle was 5,800 mm long, and the number of persons gassed in it was not “ca. 50” but between 80 and 100 persons. The file memo of 5 June 1942, which is not unknown to you, mentions 9 to 10 persons per m<sup>2</sup>.

The problem of the large pressure developing in the cargo box seems to have been known to the persons involved in the development and deployment of the gas vans. This is suggested by the frequent measurements conducted and by the already mentioned file memo of 5 June

1942. In it it says: “The known explosion at Kulmhof has to be assessed as a single case. Its cause is to be ascribed to an operating error.” This explosion and its consequences are confirmed by several witnesses. Furthermore the following is stated in the file memo of 23 June 1942 [sic]: “The slide-covered openings in the rear doors are to be omitted, and replaced with open slits of 100 × 10 mm [4" × 0.4"] in the upper back wall (not door). They are to be covered on the outside by easily movable hinged metal flaps” Hence the vehicles did have simple “pressure relief valves,” which now were to be improved due to practical experiences. (File memo of 23 June 1942, German Federal Archives, sign. R 58/871).

2. It would not be surprising if no gas vans had been found after the war, because the gas vans, like all other traces left by the extermination of people, were destroyed as best as possible in the rush. But we do not only have photos of the gas vans made by the Polish authorities after the war (in the archive in Warsaw and in the Yad Vashem Archives in Jerusalem [sic]), but according to my information there is a gas van to this day in Konin (Poland) serving as a memorial to commemorate the victims.

3. and 4. Of course one can discern differences in the terminology of the two documents mentioned by you, but, as a comparison with other extant documents reveals, this does not amount to ‘improbabilities.’

I hope to have answered your questions satisfactorily and remain with my best greetings

(signed Mathias Beer)

---



---

#### Comments by Pierre Marais

Pierre Marais submitted four questions to the Mathias Beer. Here are Marais’ four questions, followed by Beer’s answers as well as by Marais’ remarks triggered by them:

1. QUESTION: “*How could a gas van, which corresponds to the generally given description, have functioned when considering the internal pressure which the engine exhaust gases would have exerted on the walls of the sealed cargo box?*”

ANSWER: “*The problem of the large pressure developing in the cargo box seems to have been known to the persons involved in the devel-*

opment and deployment of the gas vans. This is suggested by the frequent measurements conducted and by the already mentioned file memo of 5 June 1942. [...] Furthermore the following is stated in the file memo of 23 June 1942 [correct: 1942]: ‘The slide-covered openings in the rear doors are to be omitted, and replaced with open slits of 100 × 10 mm in the upper back wall (not door).’”

REMARK: As I have already emphasized, such slits would indeed have prevented an excessive internal pressure by letting the exhaust gases escape from the cargo box. But this does not explain how the gas vans could have operated flawlessly without those slits for the first 97,000 victims which “were processed with 3 deployed vehicles.”

2. QUESTION: “Isn’t it amazing that of the thirty gas vans which are said to have been in operation not a single one has ever been found?”

ANSWER: “It would not be surprising if no gas vans had been found after the war, because the gas vans, like all other traces left by the extermination of people, were destroyed as best as possible in the rush. But we do not only have photos of the gas vans made by the Polish authorities after the war (in the archive in Warsaw and in the Yad Vashem Archives in Jerusalem [sic]), but according to my information there is a gas van to this day in Konin (Poland) serving as a memorial to commemorate the victims.”

REMARKS: The argument that there are no traces for the extermination of human beings because the “Nazis” have destroyed them does not solve the problem, yet instead exacerbates it. Instead of having to prove only one claim – “gas vans for the extermination of human beings existed” – Mathias Beer now finds himself in the situation of having to prove two claims: “gas vans for the extermination of human beings existed” and “all traces were destroyed.”

This leaves us with two pertinent bits of information given by Beer in his response to my second question: There are photos of gas vans, and most importantly: the Polish town of Konin possesses a former gas van (which would mean that not all traces had been destroyed).

As to the photos, I have shown in [chapter 2.1.] that those taken by the Polish investigative commission do show a trivial moving truck rather than a gas van. The other photos ever shown in the media have no probative value at all, as no source has ever been given for them. Hence Beer’s claim is simply wrong.

Beer’s second assertion initiated further investigations, the results of which I will disclose shortly.

3. QUESTION: “*Haven’t you noticed any improbabilities in the file memo of 5 June 1942 [Just document] and in the Becker report of 16 May 1942?*”

4. QUESTION: “*How is one to explain the entirely different phrasings of these two documents – the first tries to ‘code,’ whereas the second expressly talks about gassings and death?*”

ANSWER: “*Of course one can discern differences in the terminology of the two documents mentioned by you, but, as a comparison with other extant documents [which?] reveals, this does not amount to ‘improbabilities.’*”

REMARKS: If Beer sees only “differences in the terms used” between the two documents, then this proves a lack of critical attitude. If he doesn’t find any improbabilities, then he obviously lacks competence to investigate the issues at hand, which are mainly physical and technical in nature.

Beer’s answers devoid of any content did not warrant a continuation of this correspondence. He did not address my request to name his sources more accurately.

In order to find out more about the photos allegedly taken by the Polish investigative commission after the war, a third person sent an inquiry to the State Museum of Auschwitz and to the Yad Vashem Institute in Jerusalem [see pp. 371ff.]. I may first quote the essential sentences of the responses he received from the Auschwitz Museum:

1) “*I send you a photograph of the vehicle which served the function of a gas chamber used to murder inmates with exhaust gases in Hitler’s extermination camp CHELMNO at the river NER in the district of KONIN.*”

2) “*After the war a memorial was erected in CHELMNO on the grounds of the former extermination camp.*”

Since no further information was given as to the origin and the current archival location of this photo, no further investigations could be conducted at that time. The photo sent is identical with the one published by Fleming showing a derelict Magirus truck. The Polish investigation team taking this photo stated, however, that this was *not* a gas van but rather a simple moving truck (see [chapter 2.1.]).

The memorial in Konin mentioned by Beer was revealed as a simple stone rather than an old van by another photo sent to us by the Ausch-



witz Museum [see the illustration on p. 375]. Hence Beer must have erred.

The response by the head of the Yad Vashem archives was even more surprising. This stronghold of Holocaust hagiography sent us the same photo of the derelict Magirus moving truck, yet stated at once that beyond this they had no photos. What beats everything, though, was the request by the archive's director to inform her in case we would find another photo of a gas van and to send her a copy of it! That's a way to run an archive: let everybody send in any document they like and claim about its provenance whatever suits their purpose. Who cares about authenticity?

[*Comments by the present author:* Since Illustration 15 in Appendix 1, taken in 2010 from the Internet, sports a caption saying that it's from the Yad Vashem archives, who in return must have received it from the Polish archive owning the originals, it is safe to say that Yad Vashem's plea was finally heard by someone. In fact, their online database reveals that they received two of their images from orthodox Holocaust historian Michael Tregenza and German Nazi hunter Adalbert Ruckerl.<sup>131</sup> Yad Vashem's "gas van" images showing the Ostrowski moving truck bear misleading or outright false captions, like (archival signature in parentheses):

*"Kolo, Poland, A Magirus van found after the war, suspected as a gas van used for murder in Chelmno camp."* (1264/2 & 1007/31; similar 1427/84)

*"Chelmno, Poland, A gas van."* (5318/232)

It is also hard to believe that back in the late 1980s and early 1990s, when those inquiries were made, neither Yad Vashem nor the Auschwitz Museum knew the results of this Polish investigative commission. If they did know it, then they lied to us. If they did not know it, then they were crassly incompetent. SA]

Regarding the alleged "gas van memorial in Konin" I first contacted the Polish embassy in Paris, then the city authorities of Konin, and finally the town authorities of Chelmno. Only the city authorities of Konin answered [see next page]. I have quoted their brief but unequivocal answer at the very beginning of this study, and I may repeat it here:

*"There is no gas van serving as a memorial in our town."*

---

<sup>131</sup> Archival signatures 5318/232 and 1007/31, respectively; for their current holdings of "gas van" pictures use their image search engine at <http://collections.yadvashem.org/photosarchive/en-us/search.html>

Hence the information obtained as a result of Beer's study and the exchange with him corroborate the conclusions arrived at in this study, namely that no material traces of gas vans exist.

Letter by the Town of Konin to P. Marais

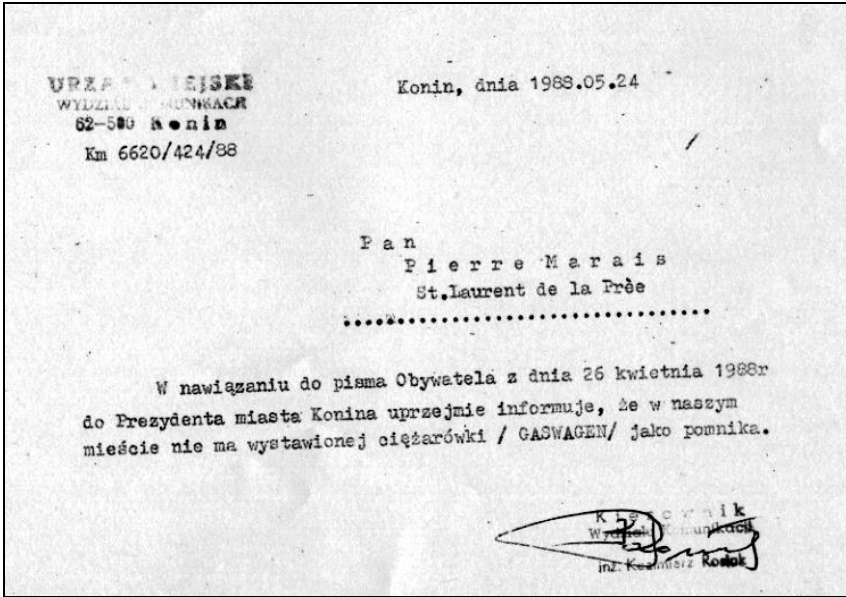

Translation

(Letterhead omitted)

Mr. Pierre Marais

In connection with your letter of 26 April 1988 to the mayor of the town of Konin I politely inform you that there is no gas van serving as a memorial in our town.

Head of Public Relations

Ing. Kazimierz Robak

## Letter by Auschwitz Museum (Poland)

Oświęcim 19.02.1983.

Szanowna Pani [REDACTED]!

Przesyłam fotografię samochodu pełniącego funkcję komory do mordowania gazem spalinywym więźniów w hitlerowskim obozie zagłady w CHELMNIE nad Nerem koło KÖNIGNA. Myślę, że o tą fotografię Pani chodzi.

Na terenie byłego obozu zagłady w CHELMNIE po wojnie postawiono pomnik. Fotografia pomnika znajduje się w albumie "MIEJSCA WYKAZENIA I KILKI ŻYDÓW NA ZIEMIACH POLSKICH 1939-1945" strona 49-50, który przesyłam.

Przy pomocy gazów spalinywych w specjalnie skonstruowanych samochodach wymordowane w latach wojny około 330 tys. Żydów, kilka tysięcy Cyganów, około 5 tysięcy jeńców radzieckich oraz dzieci czeskich w Lidic i polskich w Łamocinie.

Fotografia samochodu fot. zwanej "DUSZĘBURK" również jest umieszczona w Muzeum w Oświęcimiu w bloku 27 - na ekspozycji poświęconej zagładzie Żydów w byłym hitlerowskim obozie koncentracyjnym w Oświęcimiu (KL Auschwitz - Birkenau).

Z szacunkiem  
Mariusz CIPIOR

## Translation

Dear Mrs. [REDACTED]!

I send you a photograph of the vehicle which served the function of a gas chamber used to murder inmates with exhaust gases in Hitler's extermination camp CHELMNO at the river NER in the district of KON-IN.

I think that this is the photo you are interested in.

After the war a memorial was erected in CHELMNO on the grounds of the former extermination camp.

You can find the photo of this memorial in the album "Locations of Jewish Martyrdom and Fighting on Polish Soil 1939-1945," pages 49-50, which I enclose.

Roughly 330,000 Jews, several thousand gypsies and ca. 5,000 Soviet prisoners of war as well as Czech children from Lidice and from Zamosc in Poland were killed by means of exhaust gases in vehicles especially constructed for this.

The photo of the vehicle, a so-called "soul vendor," is also shown at the Auschwitz Museum in Block 27 as part of the exhibition dedicated to the extermination of the Jews in the former Hitler concentration camp AUSCHWITZ-BIRKENAU.

With my best wishes for your health

Two Letters by Yad Vashem, Jerusalem

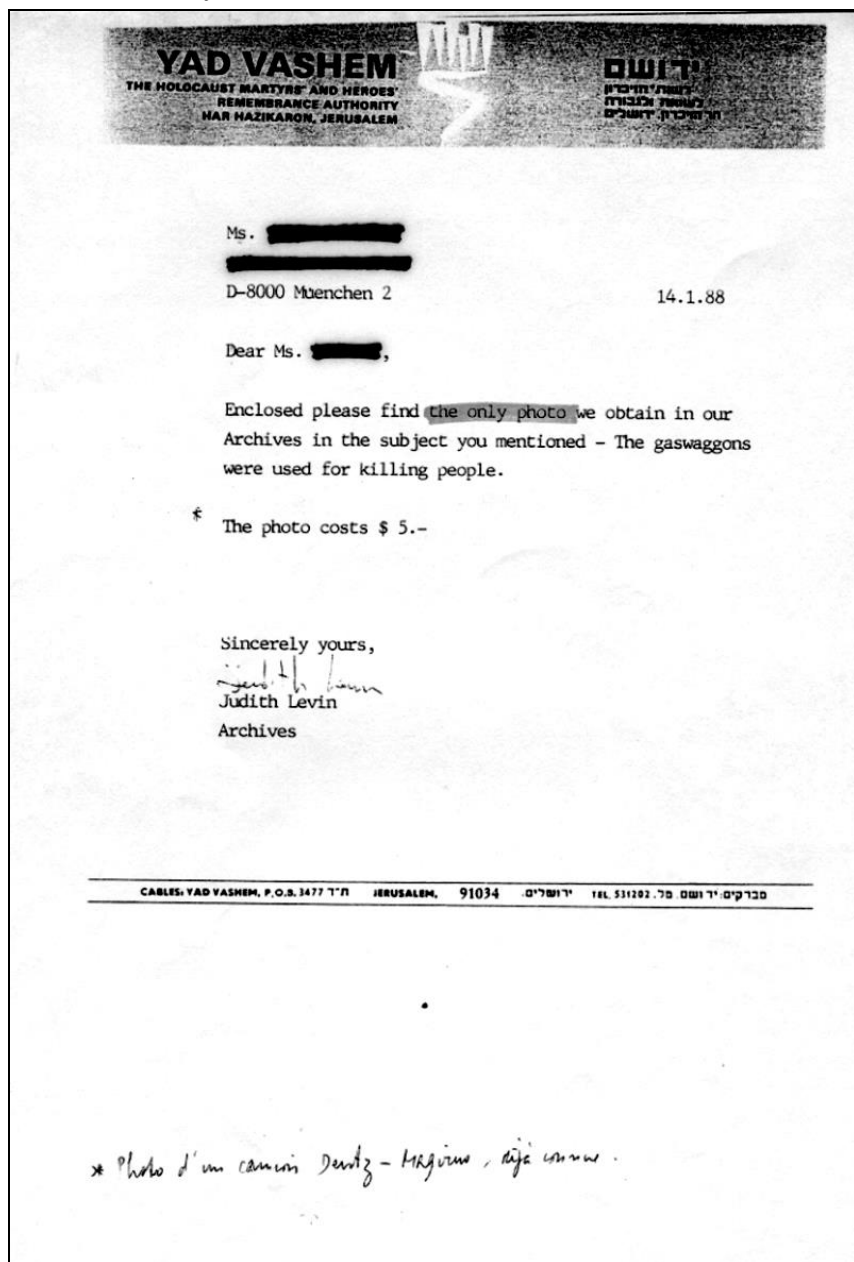

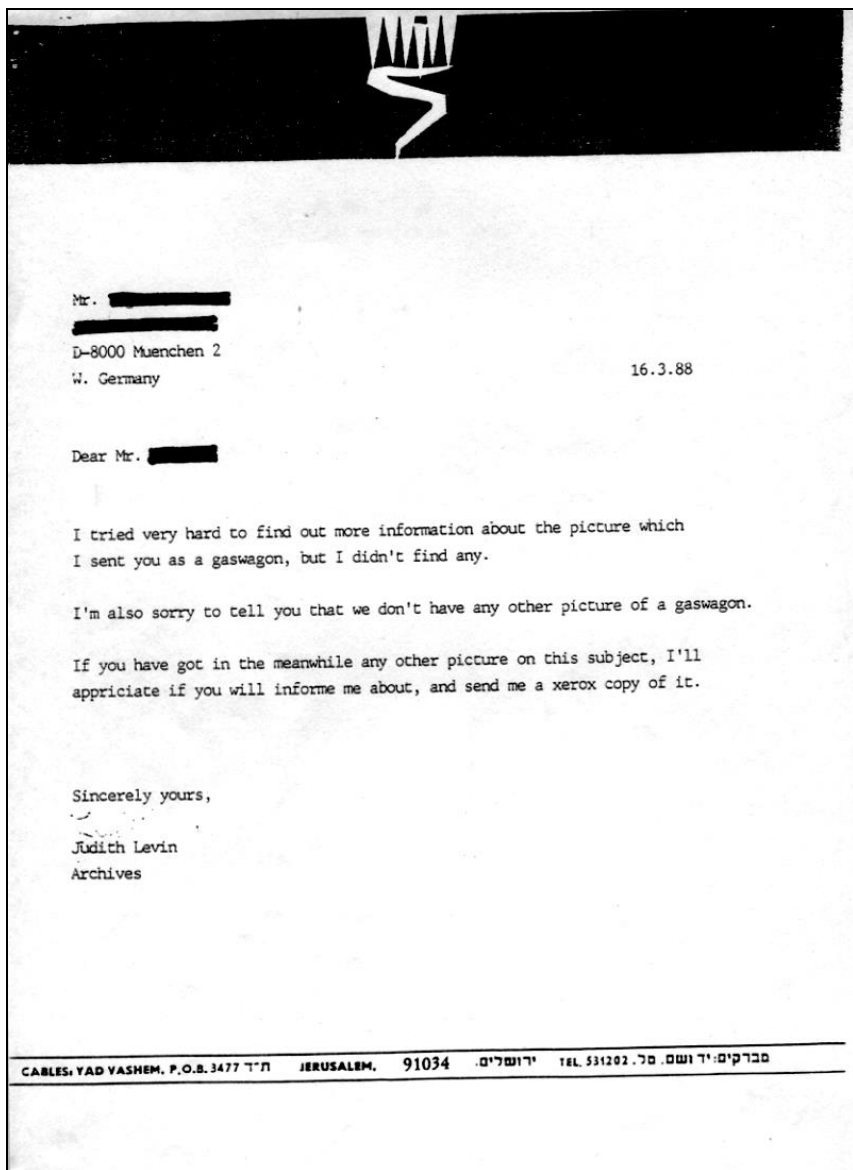

Mr. [REDACTED]  
[REDACTED]  
D-8000 Muenchen 2  
W. Germany

16.3.88

Dear Mr. [REDACTED]

I tried very hard to find out more information about the picture which I sent you as a gaswagon, but I didn't find any.

I'm also sorry to tell you that we don't have any other picture of a gaswagon.

If you have got in the meanwhile any other picture on this subject, I'll appreciate if you will inform me about, and send me a xerox copy of it.

Sincerely yours,  
Judith Levin  
Archives

### Photograph of the Chełmno Memorial





the premises of the former  
mediate extermination in Chełmno  
er, the scene of mass murder,  
f exhaust fumes from specially  
ars, of ab. 330,000 Jews,  
inds of Gypsies, ab. 5,000  
rs as well as Czech children  
nd Polish children from the Zamoké  
monument: J. Stasiński and  
z

Monument sur le terrain de l'ancien centre  
d'extermination immédiats à  
Chełmno-sur-le-Ner, lieu d'exécution  
massive au moyen des gaz d'échappement  
dans des camions spécialement construits,  
d'environ 330 000 Juifs, quelques milliers de  
Gitanes, près de 5 000 prisonniers de guerre  
soviétiques ainsi que des enfants tchèques  
de Lidice et des enfants polonais de la région  
de Zamoké.  
Auteurs du monument : J. Stasiński et  
J. Buszkiewicz

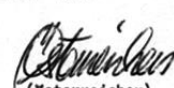

## Letter by Steyr-Daimler-Puch to P. Marais

<b>STEYR-DAIMLER-PUCH</b> Aktiengesellschaft		Werke Wien	
			
STEYR-DAIMLER-PUCH AG, Werke Wien, Pöstl. 100, A-1111 Wien		Wien 11, Zweite Haldegasse, 3	
Herrn Pierre MARAIS Rue de la poste St. Laurent de la Prée F-17450 FOURAS		Telegramm: Steyrwinn Telefon: 0222/764511/DW Serie Klappe: 363 Telex: 13010 * SDPSI * a DVR: 000070	
Ihre Zeichen	Ihre Nachricht vom 86 11 07	Unsere Zeichen	WBBK-Pi/BS Wien, 1987 01 07
Betreff: <u>"Manchetten" des SAURER - LKW, Bj. 1942 der deutschen Wehrmacht</u>			
Sehr geehrter Herr Marais!			
Wir freuen uns, Ihre Anfrage hiemit beantworten zu können und danken für die sehr makabre Briefkopie, die an die schrecklichsten Vorkommnisse des 2. Weltkrieges erinnert.			
Die damaligen "SAURER" - Wagen waren mit einer vakuumunterstützten Hydraulikbremse ausgerüstet, wie sie heute noch bei PKW und kleinen Lieferwagen nach gleichen Prinzipien verwendet wird.			
Die angesprochenen "Manchete" war dabei die Gummi-Membrane des Vakuum-Servogeräts, die sehr häufig gerissen ist, wodurch die Servounterstützung ausfiel und der Wagen nur mehr mit der Fußkraft gebremst werden konnte. Es handelte sich also nicht um einen Totalausfall, sondern nur um eine verminderte Wirksamkeit der Bremse.			
Die in diesem Brief angesprochene Form diente nicht zum "Gießen" sondern zum Vulkanisieren der Gummimembran.			
Wir hoffen, Ihnen mit dieser Auskunft gedient zu haben und verbleiben			
mit vorzüglicher Hochachtung			
STEYR-DAIMLER-PUCH Spezialfahrzeug Ges.m.b.H Kundendienst - Bus			
 (Piller)		 (Oesterreicher)	

## Translation

(Letter header and footer omitted; see comments on page 49)

Re.: “Mancheten” of the 1942 Saurer truck of the German Wehrmacht

Dear Mr. Marais!

We are glad to be able to herewith answer your inquiry and thank you for the very macabre copy of a letter which reminds at the most terrible events of the 2nd World War.

The “SAURER” vehicles from back then were equipped with vacuum-supported hydraulic brakes [power brakes] as they are still used today in cars and smaller delivery vans following the same principle.

In this connection the “Manchete” was a rubber membrane of the vacuums-supported servo device, which ruptured frequently, leading to a loss of the power support so that the vehicle could only be braked with the force of the foot. Hence this is not a complete failure but merely a reduced efficiency of the brakes.

The cast mentioned in the letter was not used to “cast” but rather to vulcanize the rubber membrane.

We hope to have served you with this information and remain

Most sincerely

Steyr-Daimler-Puch

Special Vehicles Ltd.

Customer Service – Bus

(signed: Piller and Österreicher)

## Appendix 11: Drawings of “Gas Vans”

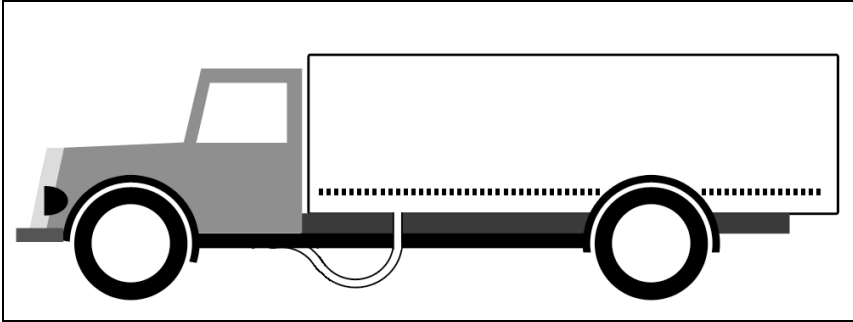

**Illustration 26:** *The Impossible Claim.* A Saurer truck with a Diesel engine, whose exhaust gases are piped via a flexible metal hose connected to a simple pipe in the bottom at the front part of the cargo box (first 20 trucks), which is hermetically sealed according to witnesses. Execution is claimed to have lasted up to 20 minutes while idling or in transit under low engine load. (Author’s drawing.)

### Problems:

1. Diesel engines, while idling or when running under low load, do not produce gases to be lethal within 20 minutes.
  2. An airtight cargo box, as claimed by many witnesses, would have burst open under the exhaust gas pressure. However, the extant documents speak of opening in the door (first 20 trucks) or in the walls (last 10 trucks).
  3. During the 1940s metal hoses of the required size were not flexible enough to make a 90° bend underneath the truck without danger of contact with the road surface. An L-shaped pipe in the floor of the cargo box would have been required, although this is not mentioned by any witness.
  4. The pipe opening in the floor could have been blocked by objects falling or fluids flowing into it. Although still functional, it is bad design.
-

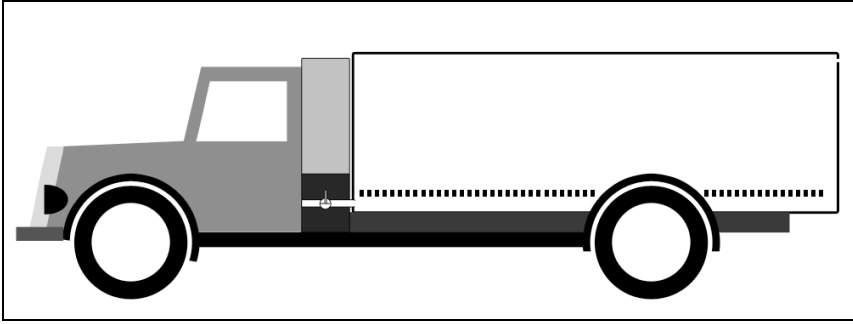

**Illustration 27:** *A Hypothetical Possibility.* A Saurer truck equipped with a wood gas generator placed between the driver's cabin and the cargo box. The gas generator's gases are highly toxic and almost instantly lethal. This gas is piped through a valve permitting to switch the gas between either the engine or the cargo box (or both, then leading to a reduced engine power). The gas enters the cargo box through a horizontal pipe underneath the wooden grate. This way no objects can fall or fluids flow into it, nor can the victims reach it through the grate. Excess gas can escape through a small opening somewhere in the walls or doors of the cargo box (as in this drawing). The floor could and would still have an opening, but merely for cleaning and draining purposes (not shown here). (Author's drawing.)

---



## Bibliography

- Adam, Uwe Dietrich, "Les chambres à gaz", in: Colloque de l'École des hautes études en sciences sociales (ed.), *L'Allemagne nazie et le génocide juif*, Gallimard-Le Seuil, Paris 1985, pp. 236-261.
- Aitken, Jessie [=Robert Faurisson], "L'Origine du mythe/Le mythe des 'chambres à gaz' remonte à 1916," *Revue d'histoire révisionniste*, no. 5, November 1991, pp. 166-172
- Alvarez, Santiago, "Lanzmann's Shoah Witness Simon Srebniak," in: *Inconvenient History*, vol. 3, no. 1 (2011), [www.inconvenienthistory.com/archive/2011/volume\\_3/number\\_1/](http://www.inconvenienthistory.com/archive/2011/volume_3/number_1/)
- Angrick, Andrej, Peter Klein, *The "final solution" in Riga: exploitation and annihilation 1941-1944*, Berghahn Books, New York/Oxford 2009.
- Apenszlak Jacob (ed.), *The Black Book of Polish Jewry*. American Federation for Polish Jews, New York 1943.
- Baldajewa, Dantschik, *GULag Zeichnungen, Zweitausendeins*, Frankfurt 1993.
- Bednarz, Władysław, *Vernichtungslager Chelmno in Polen*. USSR-340, 7 January 1946a; Engl.: "The Extermination Camp at Chelmno (Kulmhof)," in: *Central Commission for Investigation of German Crimes in Poland*, vol. I, Warsaw, 1946b; Polish that same year: "Obóz zagłady Chelmno," in: *Biuletyn Głównej Komisji Badania Zbrodni Niemieckich w Polsce*. vol. I.
- Bednarz, Władysław, *Obóz straceń w Chelmnie nad Nerem*, Państwowy Instytut Wydawniczy, Warsaw 1946c.
- Beer, Mathias "Die Entwicklung der Gaswagen beim Mord an den Juden," *Vierteljahreshefte für Zeitgeschichte*, 35 (3) 1987, pp. 403-417; Engl.: <http://dss.ucsd.edu/~lزامosc/chelm10.htm>.
- Benz, Wolfgang, Barbara Distel (eds.), *Der Ort des Terrors*, vol. 9, C.H. Beck, Munich 2009.
- Berg, Friedrich Paul, "The Diesel Gas Chambers: Myth Within A Myth," *The Journal of Historical Review*, 5(1) (1984), pp. 15-46.
- Berg, Friedrich Paul, "The German Delousing Chambers," *The Journal of Historical Review*, 7(1) (1987), pp. 73-94.
- Berg, Friedrich Paul, "Gas Chambers for Robert Faurisson: Answers to a Challenge," Oct. 1993, <http://codoh.com/gcgv/gaschamb.html>
- Berg, Friedrich Paul, "Poison Gas Über Alles," *The Revisionist* 1(1) (2003a), pp. 37-47.
- Berg, Friedrich Paul, "Diesel Gas Chambers: Ideal for Torture – Absurd for Murder," in: Rudolf 2003, pp. 435-469.
- Bishop, James A., *F.D. Roosevelt's Last Year (April 1944-April 1945)*, Hart-Davis/McGibbon, London 1975.
- Blumental, Nachman (ed.), *Dokumenty i materiały*, vol. I: "Obozy," Wydawnictwa Centralnej Żydowskiej Komisji Historycznej w Polsce, Łódź 1946.
- Bobrenjow, Wladimir, Waleri Rjasanzwe, *Das Geheimlabor des KGB*, edition q, Berlin 1993.
- Bourtman, Ilya, "'Blood for Blood, Death for Death': The Soviet Military Tribunal in Krasnodar, 1943," *Holocaust and Genocide Studies*, 22(2) 2008, pp. 246-265.

- Broszat, Martin (ed.), *Kommandant in Auschwitz*, Deutsche Verlags-Anstalt, Stuttgart 1958.
- Browning, Christopher, "The Final Solution in Serbia; The Semlin Judenlager – A Case Study," in: *Yad Vashem Studies*, vol. 15 (1983), pp. 55-90.
- Browning, Christopher R., *Fateful Months: Essays on the Emergence of the Final Solution*, Holmes and Meier, New York 1985.
- Browning, Christopher R., "Herald Turner und die Militärverwaltung in Serbien 1941-1942," in: Dieter Rebentisch, Karl Teppe (ed.): *Verwaltung contra Menschenführung im Staat Hitlers. Studien zum politisch-administrativen System*, Vandenhoeck und Ruprecht, Göttingen 1986, pp. 351-373.
- Browning, Christopher R., *The path to genocide: essays on launching the final solution*, Cambridge University Press, Cambridge 1995.
- Browning, Christopher R., *The Origins of the Final Solution: The Evolution of Nazi Jewish Policy*, Yad Vashem, Jerusalem 2004.
- Busvine, James R., *Insects and Hygiene: The Biology and Control of Insect Pests of Medical and Domestic Importance in Britain*, Methuen, London 1951.
- Byford, Jovan, "'Shortly afterwards, we heard the sound of the gas van.' Survivor Testimony and the Writing of History," *History & Memory*, vol. 22, no. 1 (Spring/Summer 2010), pp. 5-47.
- Chelain, André, *La thèse de Nantes et l'affaire Roques*, Polémiques, Paris 1989.
- Choumoff, Pierre-Serge, "Les assassinats par gaz à Mauthausen et Gusen," in: *Le Monde juif*, 5 October 1986.
- Choumoff, Pierre-Serge, *Le Monde juif*, nos. 123 and 124, 1st trimestre 1987.
- Crowell, Samuel, *The Gas Chamber of Sherlock Holmes: An Attempt at a Literary Analysis of the Holocaust Gassing Claim*, 2000, online at <http://codoh.com/newsite/articles/samuelfcrowell/xsherlock.pdf>; slightly revised as *The Gas Chamber of Sherlock Holmes and Other Writings on the Holocaust, Revisionism, and Historical Understanding*, Nine Banded Books, Charlston, WV, 2011.
- Davies, William J.L., *German Army Handbook*, Arco Publishing, New York 1973.
- de Zayas, Alfred M., *The German Expellees: Victims in War and Peace*, St. Martin's Press, New York 1993.
- Dötzer, Walter, *Entkeimung, Entseuchung und Entwesung*, 3rd ed., part of the series *Arbeitsanweisungen für Klinik und Laboratorium des Hygiene-Institutes der Waffen SS*, Berlin, Urban & Schwarzenberg, Berlin/Vienna 1944.
- Embassy of the Union of Soviet Socialist Republics, *On Crimes Committed by the German-Fascist Occupation Troops in the Stavropol Area: Soviet War Documents*, Information Bulletin, Special Supplement, Washington, D.C, December 1943.
- Fleming, Gerald, *Hitler and the Final Solution*, University of California Press, Berkeley 1984.
- Frank, Reinhard, *Lastkraftwagen der Wehrmacht*, Podzun-Pallas, Friedberg 1992.
- Freund, Florian, Bertrand Perz, Karl Stuhlpfarrer, "Historische Überreste von Tötungseinrichtungen im KZ Mauthausen", *Zeitgeschichte* (Vienna), 22 (1995), pp. 297-317.
- Friedlander, Henry, Sybil Milton (eds.), *Berlin Document Center, Archives of the Holocaust*, vol. 11, Garland, New York 1992.
- Friedlander, Henry, Sybil Milton (eds.), *Zentrale Stelle der Landesjustizverwaltungen, Ludwigsburg, Archives of the Holocaust*, vol. 22, Garland, New York 1993.
- Friedländer, Saul, *Kurt Gerstein et l'ambiguïté du bien*, Casterman, Paris 1967.
- Gauss, Ernst [=Germar Rudolf], *Grundlagen zur Zeitgeschichte*, Grabert, Tübingen 1994.

- Gerlach, Christian, "Failure of Plans for an SS Extermination Camp in Mogilev, Belorussia", in: *Holocaust and Genocide Studies*, 11(1), Spring 1997, pp. 60-78 (<http://hgs.oxfordjournals.org/content/11/1/60.full.pdf>).
- Geyer, Georgie Anne, *Buying the Night Flight*, University of Chicago Press 2001.
- Giese, G. "Der Mann, der den Papst verschleppen sollte," *neue bildpost*, in nine installments, April 21 to June 16, 1974.
- Graf, Jürgen, Thomas Kues, Carlo Mattogno, *Sobibór*, The Barnes Review, Washington 2010.
- Grigorenko, Petr G., *Memoirs*, Norton, New York 1982.
- IMT: Trial of the Major War Criminals before the International Military Tribunal, various vols., U.S. Government Printing Office, Washington, DC, 1947-1949; [http://www.loc.gov/rr/frd/Military\\_Law/NT\\_major-war-criminals.html](http://www.loc.gov/rr/frd/Military_Law/NT_major-war-criminals.html)
- Johnson, Eric A., Karl-Heinz Reuband, *What We Knew: Terror, Mass Murder, and Everyday Life in Nazi Germany*, John Murray, London 2005.
- Keeser, Eduard, Viktor Froboese, Richard Turnau, *Toxikologie und Hygiene des Kraftfahrwesens (Auspuffgase und Benzine)*, Verlag von Julius Springer, Berlin 1930.
- Kempner, Robert M., *Eichmann und Komplizen*, Europa Verlag, Zürich 1961.
- Klamper, Elisabeth (ed.), *Dokumentationsarchiv des österreichischen Widerstandes Vienna*, part of: Henry Friedlander, Sybil Milton (eds.), *Archives of the Holocaust*, vol. 19, Garland, New York 1991.
- Klee, Ernst "Euthanasie" im NS-Staat, 11th ed. Fischer-Taschenbuch, Frankfurt/Main 2004.
- Klee, Ernst, Willi Dreßen, Volker Rieß, "Schöne Zeiten": *Judenmord aus der Sicht der Täter und Gaffer*, S. Fischer, Frankfurt 1988; Engl.: "The Good Old Days": *the Holocaust as seen by its perpetrators and bystanders*, Free Press, New York 1991.
- Kogon, Eugen, Hermann Langbein, Adalbert Rückerl et al., *Nationalsozialistische Massentötungen durch Giftgas*, S. Fischer Verlag, 1983, 1986; French: *Les Chambres à gaz, secret d'État*, Éditions de Minuit, 1984, 1987; Engl.: *Nazi Mass Murder: a documentary history of the use of poison gas*, Yale University Press, New Haven 1993.
- Kohl, Paul, *Das Vernichtungslager Trostenez. Augenzeugenberichte und Dokumente*, Internationales Bildungs- und Begegnungswerk, Dortmund 2003.
- Köhler, Manfred, "The Value of Testimony and Confessions Concerning the Holocaust," in: G. Rudolf 2003, pp. 85-131.
- Krakowski, Shmuel, *Das Todeslager Chelmno/Kulmhof. Der Beginn der "Endlösung."* Yad Vashem/Wallstein, Göttingen 2007.
- Kranz, Tomasz, *Zur Erfassung der Häftlingssterblichkeit im Konzentrationslager Lublin*. Państwowe Muzeum na Majdanku, Lublin 2007.
- Krausnick, Hans, Hans-Heinrich Wilhelm, *Die Truppe des Weltanschauungskrieges*, Deutsche Verlags-Anstalt, Stuttgart 1981.
- Kues, Thomas, "Thomas Mann's War-time Radio Speeches and the Genesis of the Mass Gassing Allegations," *Smith's Report*, no. 175, Sept. 2010, pp. 1f., 9-11
- Lanzmann, Claude, *Shoah*, Fayard, Paris 1985; witness statements quoted from the movie transcript at [www.script-o-rama.com/movie\\_scripts/s/shoah-script-transcript-holocaust.html](http://www.script-o-rama.com/movie_scripts/s/shoah-script-transcript-holocaust.html); [www.youtube.com/watch?v=5W0WcZu9O74](http://www.youtube.com/watch?v=5W0WcZu9O74)
- Laqueur, Walter, *Terrible Secret: An Investigation into the Suppression of Information about Hitler's 'Final Solution.'* Weidenfeld and Nicolson, London 1980.
- Lebailly, Jacques, "Interview with Michel De Boüard on the 'Thesis of Nantes'," *Journal of Historical Review*, 8(3) (1988), pp. 381-384.
- Leuchter, Fred A., Robert Faurisson, Germar Rudolf, *The Leuchter Reports. Critical Edition*, 2nd ed., The Barnes Review, Washington, DC, 2011.



- Loewenstein, Karl, *Minsk. Im Lager der deutschen Juden*, Bundeszentrale für Heimatdienst, Bonn 1961.
- Mann, Thomas, *Deutsche Hörer! 55 Radiosendungen nach Deutschland*, 2nd ed., Bermann-Fischer, Stockholm 1945.
- Manoschek, Walter, "Serbien ist judenfrei": *militärische Besatzungspolitik und Judenvernichtung in Serbien 1941/42*, Schriftenreihe des Militärgeschichtlichen Forschungsamtes, Bd. 38, 2nd ed., Munich 1995, pp. 169-184.
- Manoschek, Walter, "Die Vernichtung der Juden in Serbien," in: Ulrich Herbert (ed.), *Nationalsozialistische Vernichtungspolitik. Neue Forschungen und Kontroversen*, Fischer, Frankfurt/Main 1998, pp. 209-234.
- Marais, Pierre, *Les camions à gas en question*, Polemique, Paris 1994; Germ.: *Die Gaswagen. Eine kritische Untersuchung*, Castle Hill Publishers, Hastings 2009.
- Maršálek, Hans, *Die Geschichte des Konzentrationslagers Mauthausen*, Österreichische Lagergemeinschaft Mauthausen, Vienna 1980.
- Mattogno, Carlo, *Belžec in Propaganda, Testimonies, Archeological Research, and History*, Theses & Dissertations Press, Chicago 2004a.
- Mattogno, Carlo, *The Bunkers of Auschwitz*, Theses & Dissertations Press, Chicago 2004b.
- Mattogno, Carlo, "Flames and Smoke from the Chimneys of Crematoria," *The Revisionist*, 2(1) (2004c), pp. 73-78
- Mattogno, Carlo, *Auschwitz: Krematorium I*, Theses & Dissertations Press, Chicago, 2005a.
- Mattogno, Carlo, *Auschwitz: The First Gassing*, Theses & Dissertations Press, Chicago, 2005b.
- Mattogno, Carlo, *Auschwitz: The Case for Sanity*, The Barnes Review, Washington, DC, 2010.
- Mattogno, Carlo, *The Chelmno Camp in History and Propaganda*, The Barnes Review, Washington, DC, in preparation for release in 2011a.
- Mattogno, Carlo, *The Crematory Ovens of Auschwitz*, The Barnes Review, Washington, DC, in preparation for release in 2011b.
- Mattogno, Carlo, Jürgen Graf, *Treblinka*, 2nd ed., Theses & Dissertations Press, Chicago 2005.
- Milsom, John: *German Military Transport of World War Two*, Arms and Armour Press, London 1975.
- Morsch, Günter, Bertrand Perz, Astrid Ley (eds.), *Neue Studien zu nationalsozialistischen Massentötungen durch Giftgas*, Metropolis Verlag, Berlin 2011.
- NMT: Trial of War Criminals Before the Nuernberg Military Tribunals, Vol. 1, "The Medical Case"; Vol. 4, "The Einsatzgruppen Case," U.S. Government Printing Office, Washington, DC, 1950; [http://www.loc.gov/r/rfd/Military\\_Law/NTs\\_war-criminals.html](http://www.loc.gov/r/rfd/Military_Law/NTs_war-criminals.html).
- Nowak, Hans Jürgen, Werner Rademacher, "Some Details of the Centralconstruction Office of Auschwitz," in: Rudolf 2003, pp. 311-336.
- Oswald, Werner, *Kraftfahrzeuge und Panzer der Reichswehr, Wehrmacht und Bundeswehr*, Motorbuch, Stuttgart 1990.
- Paget, Reginald T., *Manstein: His Campaigns and his Trial*, Collins, London 1951.
- Pattle, R.E., H. Stretch, F. Burgess, et al., "The Toxicity of Fumes from Diesel Engine under Four Different Running Conditions," *British Journal of Industrial Medicine* 14 (1957) pp. 47-55; online: [www.vho.org/GB/c/FPB/ToxDiesel.html](http://www.vho.org/GB/c/FPB/ToxDiesel.html).
- Peters, Gerhard, Emil Wüstinger, "Entlausung mit Zyklon-Blausäure in Kreislauf-Begasungskammern. Sach-Entlausung in Blausäure-Kammern," *Zeitschrift für hygienische Zoologie und Schädlingsbekämpfung*, issue 10/11 (1940), special printing.

- Podchlebnik, Michał, *Protocol of the Interrogation of the Witness*, Władysław Bednarz, Examining Judge, Łódź District Court, Koło, 9 June 1945 ([www.holocaustresearchproject.org/survivor/podchlebnik.html](http://www.holocaustresearchproject.org/survivor/podchlebnik.html)); in its original Polish reproduced in Bednarz 1946c, pp. 39-45.
- Rassinier, Paul, *Le Mensonge d'Ulysse*, La Librairie Française, Paris 1950; La Vieille Taupe, Paris 1979.
- Roques, Henri, *Les "Confessions" de Kurt Gerstein*, Université de Nantes, 1985.
- Roques, Henri, *Faut-il fusiller Henri Roques?*, Ogmios Diffusion, Paris 1986.
- Rosenberg, Heinz, *Jahre des Schreckens... und ich blieb übrig, daß ich Dir's ansage*, Steidl Verlag, Göttingen 1985.
- Rückerl, Adalbert (ed.), *NS-Prozesse*, C. F. Müller Verlag, Karlsruhe 1971, 1972.
- Rückerl, Adalbert, *NS-Vernichtungslager im Spiegel deutscher Strafprozesse*, DTV, Stuttgart 1977, 1978.
- Rudolf, Germar, *Dissecting the Holocaust*, 2nd ed., Theses & Dissertations Press, Chicago, IL, 2003.
- Rudolf, Germar, *Lectures on the Holocaust*, 2nd ed., The Barnes Review, Washington, DC, 2010.
- Rudolf, Germar, *The Rudolf Report*, 2nd ed., The Barnes Review, Washington, DC, 2011.
- Rüter, Christiaan F. et al. (eds.), *Justiz und NS-Verbrechen. Sammlung deutscher Strafurteile wegen nationalsozialistischer Tötungsverbrechen*, University Press, Amsterdam, 44 vols., ongoing since 1968.
- Rüter, Christiaan F. et al. (eds.), *DDR-Justiz und NS-Verbrechen. Sammlung ostdeutscher Strafurteile wegen nationalsozialistischer Tötungsverbrechen*, University Press, Amsterdam, 13 vols., ongoing since 2002.
- Sack, John, *An Eye for an Eye*, Basic Books, New York 1993.
- Sakowska, Ruta, *Die zweite Etappe ist der Tod. NS-Ausrottungspolitik gegen die polnischen Juden gesehen mit den Augen der Opfer*, Edition Entrich, Berlin 1993.
- Sanford, George, *Katyn and the Soviet Massacre of 1940*, Routledge, Oxford 2005.
- Schwindt, Barbara, *Das Konzentrations- und Vernichtungslager Majdanek. Funktionswandel im Kontext der "Endlösung"*, Königshausen & Neumann, Würzburg 2005.
- Seidler, Franz. W., *Die Wehrmacht im Partisanenkrieg*, Pour le Mérite, Selent 1998.
- Sharf, Andrew, "The British Press and the Holocaust," *Yad Vashem Studies*, vol. V (1963), pp. 169-191.
- Sherman-Zander, Hilde, *Zwischen Tag und Dunkel. Mädchenjahre im Ghetto*, Ullstein, Frankfurt/M. 1984.
- Siegert, Karl, "Reprisals and Orders From Higher Up," in: Rudolf 2003, pp. 529-550.
- Smoliar, Hersh, *Resistance in Minsk*, Judah L. Magnes Memorial Museum, Oakland, CA, 1966.
- Soviet Government Statements on Nazi Atrocities*, Hutchinson & Co, London 1945.
- Spiegel, Der*, "SS-Rauff: Komisch und seltsam," no. 4, 23 January 1963, p. 30; [www.spiegel.de/spiegel/print/d-45142046.html](http://www.spiegel.de/spiegel/print/d-45142046.html)
- Spiegel, Der*, "Gaswagen: Der Nerven wegen," no. 21, 16 May 1966, p. 60; [www.spiegel.de/spiegel/print/d-46407284.html](http://www.spiegel.de/spiegel/print/d-46407284.html)
- Spiegel, Der*, "Gaswagen-Morde: Andere Art," no. 14, 27 March 1967a, p. 36; see [www.spiegel.de/spiegel/print/d-46450716.html](http://www.spiegel.de/spiegel/print/d-46450716.html)
- Spiegel, Der*, "NS-Verbrechen: Trauriges Bild," no. 50, 4 Dec. 1967b, p. 116; [www.spiegel.de/spiegel/print/d-46164855.html](http://www.spiegel.de/spiegel/print/d-46164855.html)
- Spielberger, Walter J. *Spezial-Panzer-Fahrzeuge des deutschen Heeres*, Motorbuch, Stuttgart 1977.

- Srebrnik, Szymon, *Protocol of the Interrogation of the Witness*, Władysław Bednarz, Examining Judge, Łódź District Court, Koło, 29 June 1945 ([www.holocaustresearchproject.org/survivor/srebrnik.html](http://www.holocaustresearchproject.org/survivor/srebrnik.html)).
- State of Israel, Ministry of Justice, *The Trial of Adolf Eichmann. Record of Proceedings in the District Court of Jerusalem*, Jerusalem 1993 ([www.nizkor.org/hweb/people/e/eichmann-adolf/transcripts/Sessions/](http://www.nizkor.org/hweb/people/e/eichmann-adolf/transcripts/Sessions/)).
- The People's Verdict*, Hutchinson & Co., London 1944.
- The Trial in the Case of the Atrocities Committed by the German Fascist Invaders and their Accomplices in Krasnodar and Krasnodar Territory, July 14 to 17, 1943*, Foreign Languages Publishing House, Moscow 1943.
- Thompson, A. G. G., "Disinfection in the German Army in the War," *Journal of the Royal Army Medical Corps*, vol. 35, no. 3 (September 1920), pp. 228-232 pp.
- Volodarsky, Boris, *The KGB's Poison Factory: From Lenin to Litvinenko*, Frontline Books, London 2009.
- Voslensky, Michael S., *Das Geheime wird Offenbar. Moskauer Archive erzählen*, Langen Müller, Munich 1995.
- Walch, Stephan G., Dirk W. Lachenmeier, Eva-Maria Sohnus, et al., "Rapid Determination of Carboxyhemoglobin in Postmortem Blood using Fully-Automated Head-space Gas Chromatography with Methaniser and FID," *The Open Toxicology Journal*, 2010, 4, pp. 21-25; [www.bentham.org/open/totoxij/articles/V004/21TOTOXIJ.pdf](http://www.bentham.org/open/totoxij/articles/V004/21TOTOXIJ.pdf)
- Walendy, Udo, "'Vermerk' des RSHA," in: *Historische Tatsache*, Nr. 5, Verlag für Volkstum und Zeitgeschichtsforschung, Vlotho, 1979.
- Walendy, Udo "Das verbrecherische System," *Historische Tatsachen* Nr. 48, Verlag für Volkstum und Zeitgeschichtsforschung, Vlotho 1991.
- Weckert, Ingrid, "'Massentötungen' oder Desinformation?," in: *Historische Tatsachen*, No. 24, Verlag für Volkstum und Zeitgeschichtsforschung, Vlotho, 1985.
- Weckert, Ingrid, "Die Gaswagen – Kritische Würdigung der Beweislage," in: Gauss 1994, pp. 193-218.
- Weckert, Ingrid, "The Gas Vans: A Critical Assessment of the Evidence," in: Rudolf 2003, pp. 215-241.
- Wells, Tom, and Richard A. Leo. *The Wrong Guys. Murder, False Confessions, and the Norfolk Four*, New Press, New York 2008.
- Wipf, Hans Ulrich, Mario König, Adrian Knoepfli, Saurer. *Vom Ostschweizer Kleinbetrieb zum internationalen Technologiekonzern*, Baden 2003.

## Index of Names

Included are the names of individuals and companies.

- **A** —
- Adam, Uwe Dietrich: 68  
 Aitken, Jesse (=Robert Faurisson): 105  
 Alvarez, Santiago: 169  
 Alvensleben, von: 119, 121  
 Andorfer, Herbert: 171, 221f.  
 Angrick, Andrej: 266  
 Apenszlak, Jacob: 241  
 Arajs, Victor: 266
- **B** —
- Baldajewa, Dantschik: 108  
 Bar-Or, prosecutor: 144  
 Bauer, M.: 85  
 Baum, of Gaubschat Company: 333  
 Becker, August: 15f., 40f., 46, 50, 125, 131, 134-137, 174, 188-192, 207, 214, 275  
 Bednarz, Władysław: 101, 147, 154-166, 232, 255, 259-263, 267, 351f.  
 Beer, Mathias: 14-16, 19, 24, 85, 97, 107, 137, 176, 188, 191, 204, 219, 254-263, 362, 365-369  
 Beim, Aaron: 252  
 Benz, Wolfgang: 154, 259f., 263  
 Benzler, Felix: 92  
 Berg, Friedrich P.: 24-28, 54, 99, 102f., 107-109, 251, 271f.  
 Berg, Isai D.: 108f.  
 Bernier, Jean: 355  
 Biberstein, Ernst: 136f.  
 Biondi, Jean: 355  
 Bishop, James A.: 114  
 Blobel, Paul: 23, 139
- Blumental, Nachman: 259  
 Bobrenjow, Wladimir: 108  
 Bock, Heinrich: 191  
 Bond, James: 214  
 Bosiński, witness: 165  
 Boüard, Michel de: 267  
 Bourtman, Ilya: 22, 110-114  
 Brack, Viktor: 94f.  
 Braune, Karl: 137  
 Bronowski, J.: 33  
 Broszat, Martin: 217  
 Browning, Christopher: 23, 31f., 58, 88-92, 222, 259  
 Brünnert, Reinhold: 184  
 Bulanov, Mikhail: 121  
 Burmeister, Walter: 145f., 154, 196, 202, 214  
 Büssing Company: 211  
 Busvine, James R.: 99  
 Byford, Jovan: 22f., 91, 143, 245-253, 258, 267
- **C** —
- Chelain, André: 27  
 Choumoff, Pierre-Serge: 141, 254, 256, 261, 356-361  
 Chri., Theodor L., defendant: 226  
 Christmann, Kurt: 236, 238  
 Crowell, Samuel: 96, 117, 272  
 Czyzewski, Kazimierz: 255, 259
- **D** —
- Daimler Benz company: 25, 30, 32, 254, 348, 357  
 Davies, William J. L.: 97  
 Deboisse, General: 142f.  
 Decaux, Alain: 36, 280
- Deckert, Günter: 174  
 Deutz: see Klöckner-Humboldt-Deutz company  
 Diamond company: 30, 32, 35, 58f., 63, 145, 152, 187, 189, 192, 211, 214, 227, 254, 260, 357  
 Distel, Barbara: 154, 259f., 263  
 Djinchviladze, witness: 123  
 Dötzer, Walter: 99  
 Dreh., Max, defendant: 235  
 Dreßen, Willi: 145, 189, 259f.  
 Dudzinski, Zbigniew: 352  
 Dziopek, Jan: 262
- **E** —
- Ehlich, witness: 139  
 Ehrenburg, Ilya: 174  
 Ehrlinger, Erich: 184  
 Eichmann, Adolf: 94f., 143, 167-169  
 Enge, Edgar: 220f.  
 Ernst, of Gaubschat company: 326, 331  
 Ernst, SS-Untersturmführer: 45  
 Esc., Rudi F., defendant: 232
- **F** —
- Falborski, Bronisław: 32, 146-152, 155, 163-165, 176, 254f., 258, 262, 266, 349-353  
 Faurisson, Robert: 272, 360  
 Fen[i]chel, E.M.: 128f., 163, 174  
 Fin., Karl, defendant: 231  
 Fine, Gary: 252

Flatz, G.: 278  
 Fleming, Gerald: 31-33,  
 254, 275, 367  
 Fójcik, witness: 164  
 Ford company: 30, 32, 109,  
 233f., 254  
 Frank, Reinhard: 97  
 Frentzel, Georg: 242  
 Freund, Florian: 141  
 Friedlander, Henry: 88, 90,  
 216f., 259  
 Friedländer, Saul: 280  
 Fritzsche, Hans: 138  
 Froboese, Viktor: 25, 201

## — G —

Gaubtschat company: 78-  
 81, 85, 93f., 131, 145,  
 212, 218, 222, 257-260,  
 263, 270, 272, 295, 307,  
 314, 317, 326-328, 331,  
 333  
 Gauss, Ernst (= Germar  
 Rudolf): 40, 108  
 Gawlik, Hans: 139  
 Gazhik, Yevdokia  
 Fedorovna: 115  
 Gerchow, Joachim: 195  
 Gerlach, Christian: 92  
 Gerstein, Kurt: 27, 36, 280  
 Geyer, Georgie Anne:  
 132f.  
 Gielow, defendant: 145,  
 154  
 Giese, G.: 87  
 Glücks, Richard: 141  
 Gö., Heinrich, defendant:  
 231, 237  
 Goebbels, Josef: 138  
 Goercke, Kurt G.: 243  
 Göhler, Ferdinand: 175  
 Goiny-Grabowski, George:  
 256  
 Götz, Wilhelm: 56-58, 183  
 Grabowski, Kazimierz:  
 166, 261  
 Grabowski, witness: 165f.  
 Graf, Jürgen: 13, 25, 59,  
 101, 116, 201, 268, 272  
 Grigorenko, Pjotr: 107

## — H —

Ha., Hans Karl A.,  
 defendant: 223, 225f.  
 Hackenholt, Lorenz: 280  
 Haefele, Alois: 202  
 Halbersztadt, Jerzy: 33, 35,  
 151, 162, 275f.  
 Har., Adolf Josef: 205  
 Hartman, Geoffrey: 252  
 Haßler, Johann: 152, 193,  
 209  
 Heess, Walter: 217, 219  
 Heim, Roger: 360  
 Heinisch, Georg: 119-123  
 Heiln, Karl: 202  
 Heuser, Obersturmführer:  
 178  
 Heydrich, Reinhardt: 174  
 Hildebrandt, Richard: 90  
 Himmler, Heinrich: 87-90,  
 122, 138, 140-143, 174,  
 189, 355  
 Hitler, Adolf: 33, 108, 114,  
 119, 122, 138, 174, 239,  
 247, 250, 317, 331, 333,  
 342, 367, 372  
 Hoffmann, Helmut: 213  
 Höppner, Rolf Heinz: 139  
 Höß, Rudolf: 166, 217  
 Hostettler, John: 111  
 Humboldt-Deutz: see  
 Klöckner-Humboldt-  
 Deutz company

## — I —

Inozemtseva, witness: 117  
 Irving, David: 88  
 Israel, Bruno: 157, 161f.

## — J —

Jankowski, witness: 164,  
 352  
 Jodl, Alfred: 138  
 Johnson, Eric A.: 255  
 Junkiert, witness: 164, 352  
 Just, Willy: 39, 58, 66, 68

## — K —

Kallmeyer, Helmut: 94f.  
 Kaltenbrunner, Ernst: 122,  
 140, 142  
 Kauffmann, Kurt: 128  
 Keeser, Eduard: 25, 201

Keh., Walter, defendant:  
 234  
 Kempner, Robert M.: 91  
 Kinder, Johannes E.: 242  
 Klamper, Elisabeth: 261,  
 357  
 Klee, Ernst: 145, 189, 254,  
 259f.  
 Klein, Peter: 262, 266  
 Klöckner-Humboldt-Deutz  
 company: 25, 32f., 147,  
 163f., 176, 254, 348,  
 367f.  
 Knoepfli, Adrian: 24  
 Kogon, Eugen: 52, 62f., 67,  
 69, 81f., 131, 145f., 154,  
 170, 173f., 196, 208, 216,  
 253-264, 334-336, 356  
 Kohl, Paul: 152, 260-263  
 Köhler, Manfred: 125, 236  
 König, Mario: 24  
 König, Ralf: 165  
 Koszeinski, physician: 139  
 Kotov, witness: 117  
 Kraft- und  
 Reichsstrassenbauamt,  
 company: 162  
 Krakowski, Shmuel: 162  
 Kranz, Tomasz: 265  
 Krausnick, Hans: 216  
 Kre., Karl Ernst R.,  
 defendant: 226  
 Krebsbach, physician: 140  
 Krieger, of Gaubtschat  
 company: 314, 326, 331  
 Kues, Thomas: 12f., 106,  
 116, 180, 268, 272

## — L —

Laabs, Gustav: 146, 154,  
 201-203  
 Langheld, Wilhelm: 120  
 Lanzmann, Claude: 148f.,  
 169, 255, 263  
 Laqueur, Walter: 105  
 Laternser, Hans: 139  
 Lawrence, Geoffry: 128  
 Lebailly, Jacques: 267  
 Leiding, Friedrich: 213  
 Lemaître, Claude: 355  
 Leo, Richard A.: 127  
 Leuchter, Fred A.: 272, 360

- Lewandowski, witness: 164, 166, 352  
 Ley, Astrid: 16, 26f., 261-265  
 Lip., Theodor, defendant: 231  
 Loewenstein, Karl: 255, 260f., 266  
 Lohse, Heinrich: 94
- **M** —  
 Magirus: see Klöckner-Humboldt-Deutz company  
 Mahler, Horst: 174  
 Mańkowski, Bronisław: 151, 164  
 Mann, Thomas: 106f.  
 Manoschek, Walter: 23, 88, 183, 221, 252, 255, 259-262  
 Manstein, Erich von: 234f.  
 Marais, Pierre: 11f., 15f., 19, 36, 43, 49, 63, 72, 84-86, 191, 198, 272f., 311, 355, 362-365, 370, 376f.  
 Martin, Ernst: 357  
 Maršálek, Hans: 139-142, 298  
 Mattogno, Carlo: 12-15, 25, 27, 38, 59, 101, 116, 123, 144, 146, 160, 169, 192, 201, 218, 259, 266, 268, 271f., 280  
 Meier, Kurt: 191  
 Mengele, Josef: 252  
 Meyer, Artur: 260  
 Meyer, Erwin: 56-58, 183  
 Meyerhoff, Hans: 152  
 Meyszner, August: 88, 91, 247, 342  
 Michailov, Alexander: 108  
 Milsom, John: 97f., 346-348  
 Milton, Sybil: 88, 90, 216f., 259  
 Miszczak, Andrzej: 156, 158, 232  
 Morsch, Günter: 16, 26f., 261-265
- **N** —  
 Nebe, Arthur: 215-217  
 Niebergall, Fred: 41  
 Nowak, Hans Jürgen: 101
- **O** —  
 Ohlendorf, Otto: 85, 135f., 139, 189  
 Opel company: 30, 32, 35, 87, 189, 192, 214, 218, 254, 348, 357  
 Österreicher, of Gaubschat company: 377  
 Ostmark company: 269  
 Ostrowski company: 33-35, 147, 149, 155, 161-166, 170, 352, 368  
 Oswald, Werner: 97  
 Otto Koehn company: 34
- **P** —  
 Paget, Reginald T.: 235  
 Paland, Herbert H.: 241  
 Pattle, R.E.: 25, 69  
 Pechersky, Alexander: 116  
 Perz, Bertrand: 16, 26f., 141, 261-265  
 Peters, Gerhard: 96  
 Piaskowski, Jozef: 151, 164f.  
 Piller, of Gaubschat company: 377  
 Piller, Walter: 145f., 196f., 263  
 Pinochet, General: 134  
 Podchlebnik, Michał: 156-159, 167, 169, 255, 259-263  
 Porter, Carlos: 42  
 Pradel, Friedrich: 56f., 78, 85, 131, 134, 190, 207-212, 297  
 Prusin, Alexander V.: 111
- **R** —  
 Rademacher, Werner: 101  
 Rassinier, Paul: 40, 355  
 Rauff, Walther: 16, 40-44, 52, 60, 66, 81f., 125, 130-135, 139, 141, 210f., 275, 288, 297f., 309, 315  
 Reder, Rudolf: 27  
 Rediess, Wilhelm: 275  
 Reithmann, Christian: 25  
 Remer, Otto E.: 174  
 Renault company: 30, 32, 145, 192, 214, 254, 357  
 Retzlaff, Reinhard: 120  
 Reuband, Karl-Heinz: 255  
 Ribbentrop, Joachim von: 91  
 Richter, Heinz R.H.: 206, 223, 225  
 Rie., Heinz G., defendant: 174, 233, 241  
 Rieß, Volker: 145, 189, 259f.  
 Riquet, Michel: 355, 360f.  
 Ritz, Hans: 120  
 Rjasanzwe, Waleri: 108  
 Robak, Kazimierz: 370  
 Robert J., van Pelt: 265  
 Roques, Henri: 27  
 Rosa, Zenon: 352  
 Rosenberg, Heinz: 255, 259-261  
 Ross, Colin: 137  
 Rossa, witness: 166  
 Roszak, Zygmunt: 352  
 Rube, Adolf: 178f.  
 Ruckerl, Adalbert: 82, 173, 261, 336-338, 368  
 Rudolf, Germar: 13, 24f., 40, 54, 98, 102-105, 109, 125, 174, 210, 269-272, 360  
 Rühl, Felix: 190  
 Rüter, Christiaan F.: 53f., 59, 73, 169, 182, 195, 239, 241, 264
- **S** —  
 Sack, John: 144  
 Sackenreuter, driver: 137  
 Sakowska, Ruta: 260-263  
 Sanford, George: 21, 111  
 Sattler, Bruno W.: 243  
 Saurer company: 18, 24, 29-32, 35, 44f., 49-53, 56-60, 64, 66, 69-74, 87, 92f., 102f., 125, 129-131, 145, 154, 163, 166, 180-183, 187, 189, 192, 204, 211-214, 219f., 254-261, 264, 269, 272, 278, 298, 314f., 326, 331, 333, 357, 364, 377-379

- Schäfer, Emanuel: 56, 180-182, 222, 244  
 Schindler, Oskar: 252  
 Schirach, Baldur von: 137f.  
 Schl., Heinz Joachim, defendant: 224-230  
 Schlu., Johannes P., defendant: 232  
 Schuchard, Siegfried: 231  
 Schumacher, Hans: 184-186  
 Schwindt, Barbara: 264, 385  
 Seidler, Franz. W.: 17  
 Sev., Friedrich, defendant: 231  
 Sharf, Andrew: 106  
 Sherman-Zander, Hilde: 255, 261, 265  
 Siegert, Karl: 17  
 Smirnov, L.N.: 128, 162  
 Smoliar, Hersh: 255  
 Sodomka company: 326  
 Spielberg, Walter J.: 97  
 Srebrnik, Szymon: 32, 154, 156, 159, 165-169, 202, 254, 259, 263  
 Stalin, Joseph: 108, 113  
 Steinke, Alexander: 196  
 Steyr-Daimler-Puch company: 49, 376f.  
 Stolz, Sylvia: 174f.
- Stro., Karl, defendant: 230  
 Stuhlpfarrer, Karl: 141  
 Sukkel: 58, 326, 331  
 Szablewski, Marian: 352  
 Szlamek, witness: 241, 262
- T —
- Teslya, Vasily I.: 107  
 Thompson, A.G.G.: 162  
 Tishchenko, Vladimir: 112, 116  
 Töben, Fredrick: 174  
 Tri., Kurt, defendant: 231  
 Trühe, SS-Hauptsturmführer: 58  
 Trunk, Achim: 26-28  
 Turnau, Richard: 25, 201  
 Turner, Harald: 39, 87-92, 221, 341f.
- U —
- U., Walter, witness: 221
- V —
- Verbeke, Siegfried: 174  
 Volodarsky, Boris: 108  
 Voslensky, Michael S.: 109
- W —
- Walch, Stephan G.: 21  
 Walendy, Udo: 75f., 107, 174
- Wasiczki, physician: 141  
 Wecker, Ingrid: 16, 40f., 63, 66f., 78-82, 130, 142, 198, 328  
 Wellers, Georges: 69  
 Wells, Tom: 127  
 Wentritt, Harry: 85, 207-214  
 Werner, Paul: 219  
 Wetzel, Erhard: 39, 94  
 Widmann, Albert: 15, 215-220, 230, 242f.  
 Wilhelm, Hans-Heinrich: 216  
 Win., Heinrich A., defendant: 232  
 Wipf, Hans Ulrich: 24  
 Wolff, Karl: 87, 341  
 Wüstinger, Emil: 96
- Z —
- Zamosc, Leon: 33  
 Zayas, Alfred de: 144  
 Ziereis, Franz: 139-142  
 Zündel, Ernst: 174f.  
 Żurawski, Mieczysław: 101, 154, 156, 159-161, 165-170, 267

# HOLOCAUST HANDBOOKS

This ambitious, growing series addresses various aspects of the “Holocaust” of the WWII era. Most of them are based on decades of research from archives all over the world. They are heavily referenced. In contrast to most other works on this issue, the tomes of this series approach its topic with profound academic scrutiny and a critical attitude. Any Holocaust researcher ignoring this series will remain oblivious to some of the most important research in the field. These books are designed to both convince the common reader as well as academics. The following books have appeared so far, or are about to be released. Compare hardcopy and eBook prices at [www.findbookprices.com](http://www.findbookprices.com).

## SECTION ONE:

### General Overviews of the Holocaust

#### **The First Holocaust. The Surprising Origin of the Six-Million Figure.**

By Don Heddesheimer. This compact but substantive study documents propaganda spread prior to, during and after the FIRST World War that claimed East European Jewry was on the brink of annihilation. The magic number of suffering and dying Jews was 6 million back then as well. The book details how these Jewish fundraising operations in America raised vast sums in the name of feeding suffering Polish and Russian Jews but actually funneled much of the money to Zionist and Communist groups. 5th ed., 200 pages, b&w illustrations, bibliography, index. (#6)

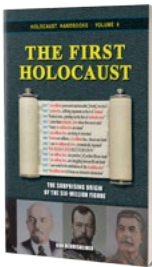

neled much of the money to Zionist and Communist groups. 5th ed., 200 pages, b&w illustrations, bibliography, index. (#6)

#### **Lectures on the Holocaust. Controversial Issues Cross Examined.**

By Germar Rudolf. This book first explains why “the Holocaust” is an important topic, and that it is well to keep an open mind about it. It then tells how many mainstream scholars expressed doubts and subsequently fell from grace. Next, the physical traces and documents about the various claimed crime scenes and murder weapons are discussed. After that, the reliability of witness testimony is examined. Finally, the author lobbies for a free exchange

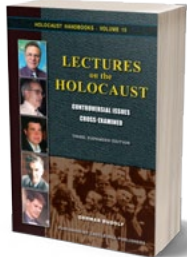

of ideas about this topic. This book gives the most-comprehensive and up-to-date overview of the critical research into the Holocaust. With its dialog style, it is pleasant to read, and it can even be used as an encyclopedic compendium. 3rd ed., 596 pages, b&w illustrations, bibliography, index. (#15)

#### **Breaking the Spell. The Holocaust, Myth & Reality.**

By Nicholas Kollerstrom. In 1941, British Intelligence analysts cracked the German “Enigma” code. Hence, in 1942 and 1943, encrypted radio communications between German concentration camps and the Berlin headquarters were decrypted. The intercepted data



Pictured above are all of the scientific studies that comprise the series *Holocaust Handbooks* published thus far or are about to be released. More volumes and new editions are constantly in the works. Check [www.HolocaustHandbooks.com](http://www.HolocaustHandbooks.com) for updates.

refutes the orthodox “Holocaust” narrative. It reveals that the Germans were desperate to reduce the death rate in their labor camps, which was caused by catastrophic typhus epidemics. Dr. Kollerstrom, a science historian, has taken these intercepts and a wide array of mostly unchallenged corroborating evidence to show that “witness statements” supporting the human gas chamber narrative clearly clash with the available scientific data. Kollerstrom concludes that the history of the Nazi “Holocaust” has been written by the victors with ulterior motives. It is distorted, exaggerated and largely wrong. With a foreword by Prof. Dr. James Fetzer. 5th ed., 282 pages, b&w ill., bibl., index. (#31)

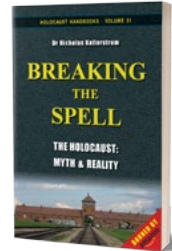

#### **Debating the Holocaust. A New Look at Both Sides.**

By Thomas Dalton. Mainstream historians insist that there cannot be, may not be, a debate about the Holocaust. But ignoring it does not make this controversy go away. Traditional scholars admit that there was neither a budget, a plan, nor an order for the Holocaust; that the key camps have all but vanished, and so have any human remains; that material and unequivocal documentary evidence is absent; and that there are serious problems with survivor testimonies. Dalton juxtaposes the traditional Holocaust narrative with revisionist challenges and then analyzes the mainstream’s responses to them. He reveals the weaknesses of both sides, while declaring revisionism

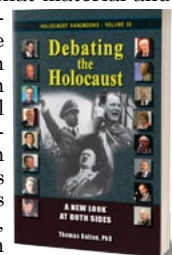



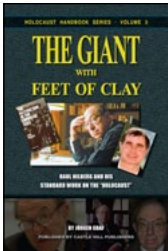
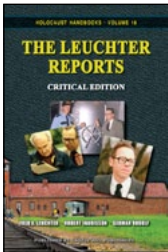
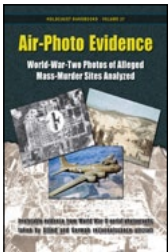
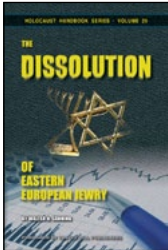
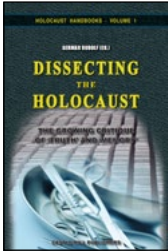
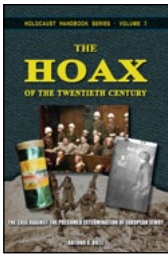

the winner of the current state of the debate. 2nd ed., 332 pages, b&w illustrations, bibliography, index. (#32)

**The Hoax of the Twentieth Century. The Case against the Presumed Extermination of European Jewry.** By Arthur R. Butz. The first writer to analyze the entire Holocaust complex in a precise scientific manner. This book exhibits the overwhelming force of arguments accumulated by the mid-1970s. Butz's two main arguments are: 1. All major entities hostile to Germany must have known what was happening to the Jews under German authority. They acted during the war as if no mass slaughter was occurring. 2. All the evidence adduced to proof any mass slaughter has a dual interpretation, while only the innocuous one can be proven to be correct. This book continues to be a major historical reference work, frequently cited by prominent personalities. This edition has numerous supplements with new information gathered over the last 35 years. 4th ed., 524 pages, b&w illustrations, bibliography, index. (#7)

**Dissecting the Holocaust. The Growing Critique of 'Truth' and 'Memory.'** Edited by Germar Rudolf. *Dissecting the Holocaust* applies state-of-the-art scientific technique and classic methods of detection to investigate the alleged murder of millions of Jews by Germans during World War II. In 22 contributions—each of some 30 pages—the 17 authors dissect generally accepted paradigms of the “Holocaust.” It reads as exciting as a crime novel: so many lies, forgeries and deceptions by politicians, historians and scientists are proven. This is the intellectual adventure of the 21st century. Be part of it! 3rd ed., ca. 630 pages, b&w illustrations, bibliography, index. (#1)

**The Dissolution of Eastern European Jewry.** By Walter N. Sanning. Six Million Jews died in the Holocaust. Sanning did not take that number at face value, but thoroughly explored European population developments and shifts mainly caused by emigration as well as deportations and evacuations conducted by both Nazis and the Soviets, among other things. The book is based mainly on Jewish, Zionist and mainstream sources. It concludes that a sizeable share of the Jews found missing during local censuses after the Second World War, which were so far counted as “Holocaust victims,” had either emigrated (mainly to Israel or the U.S.) or had been deported by Stalin to Siberian labor camps. 2nd ed., foreword by A.R. Butz, epilogue by Germar Rudolf containing important

updates; 224 pages, b&w illustrations, bibliography (#29).

**Air Photo Evidence: World War Two Photos of Alleged Mass Murder Sites Analyzed.** By Germar Rudolf (editor). During World War Two both German and Allied reconnaissance aircraft took countless air photos of places of tactical and strategic interest in Europe. These photos are prime evidence for the investigation of the Holocaust. Air photos of locations like Auschwitz, Majdanek, Treblinka, Babi Yar etc. permit an insight into what did or did not happen there. The author has unearthed many pertinent photos and has thoroughly analyzed them. This book is full of air photo reproductions and schematic drawings explaining them. According to the author, these images refute many of the atrocity claims made by witnesses in connection with events in the German sphere of influence. 5th edition; with a contribution by Carlo Mattogno. 168 pages, 8.5”x11”, b&w illustrations, bibliography, index (#27).

**The Leuchter Reports: Critical Edition.** By Fred Leuchter, Robert Faurisson and Germar Rudolf. Between 1988 and 1991, U.S. expert on execution technologies Fred Leuchter wrote four detailed reports addressing whether the Third Reich operated homicidal gas chambers. The first report on Auschwitz and Majdanek became world famous. Based on chemical analyses and various technical arguments, Leuchter concluded that the locations investigated “could not have then been, or now be, utilized or seriously considered to function as execution gas chambers.” The second report deals with gas-chamber claims for the camps Dachau, Mauthausen and Hartheim, while the third reviews design criteria and operation procedures of execution gas chambers in the U.S. The fourth report reviews Pressac's 1989 tome *Auschwitz*. 4th ed., 252 pages, b&w illustrations. (#16)

**The Giant with Feet of Clay: Raul Hilberg and His Standard Work on the "Holocaust."** By Jürgen Graf. Raul Hilberg's major work *The Destruction of European Jewry* is an orthodox standard work on the Holocaust. But what evidence does Hilberg provide to back his thesis that there was a German plan to exterminate Jews, carried out mainly in gas chambers? Jürgen Graf applies the methods of critical analysis to Hilberg's evidence and examines the results in light of modern historiography. The results of Graf's critical analysis are devastating for Hilberg.

2nd, corrected edition, 139 pages, b&w illustrations, bibliography, index. (#3)

**Jewish Emigration from the Third Reich.** By Ingrid Weckert. Current historical writings about the Third Reich claim state it was difficult for Jews to flee from Nazi persecution. The truth is that Jewish emigration was welcomed by the German authorities. Emigration was not some kind of wild flight, but rather a lawfully determined and regulated matter. Weckert's booklet elucidates the emigration process in law and policy. She shows that German and Jewish authorities worked closely together. Jews interested in emigrating received detailed advice and offers of help from both sides. 2nd ed., 130 pages, index. (#12)

**Inside the Gas Chambers: The Extermination of Mainstream Holocaust Historiography.** By Carlo Mattogno. Neither increased media propaganda or political pressure nor judicial persecution can stifle revisionism. Hence, in early 2011, the Holocaust Orthodoxy published a 400 pp. book (in German) claiming to refute "revisionist propaganda," trying again to prove "once and for all" that there were homicidal gas chambers at the camps of Dachau, Natzweiler, Sachsenhausen, Mauthausen, Ravensbrück, Neuengamme, Stutthof... you name them. Mattogno shows with his detailed analysis of this work of propaganda that mainstream Holocaust hagiography is beating around the bush rather than addressing revisionist research results. He exposes their myths, distortions and lies. 2nd ed., 280 pages, b&w illustrations, bibliography, index. (#25)

## SECTION TWO: Specific non-Auschwitz Studies

**Treblinka: Extermination Camp or Transit Camp?** By Carlo Mattogno and Jürgen Graf. It is alleged that at Treblinka in East Poland between 700,000 and 3,000,000 persons were murdered in 1942 and 1943. The weapons used were said to have been stationary and/or mobile gas chambers, fast-acting or slow-acting poison gas, unslaked lime, superheated steam, electricity, diesel exhaust fumes etc. Holocaust historians alleged that bodies were piled as high as multi-storied buildings and burned without a trace, using little or no fuel at all. Graf and Mattogno have now analyzed the origins, logic and technical feasibility of the official version of Treblinka. On the basis of numerous documents they reveal Treblinka's true identity as a mere transit

camp. 2nd ed., 372 pages, b&w illustrations, bibliography, index. (#8)

**Belzec in Propaganda, Testimonies, Archeological Research and History.** By Carlo Mattogno. Witnesses report that between 600,000 and 3 million Jews were murdered in the Belzec camp, located in Poland. Various murder weapons are claimed to have been used: diesel gas; unslaked lime in trains; high voltage; vacuum chambers; etc. The corpses were incinerated on huge pyres without leaving a trace. For those who know the stories about Treblinka this sounds familiar. Thus the author has restricted this study to the aspects which are new compared to Treblinka. In contrast to Treblinka, forensic drillings and excavations were performed at Belzec, the results of which are critically reviewed. 142 pages, b&w illustrations, bibliography, index. (#9)

**Sobibor: Holocaust Propaganda and Reality.** By Jürgen Graf, Thomas Kues and Carlo Mattogno. Between 25,000 and 2 million Jews are said to have been killed in gas chambers in the Sobibór camp in Poland. The corpses were allegedly buried in mass graves and later incinerated on pyres. This book investigates these claims and shows that they are based on the selective use of contradictory eyewitness testimony. Archeological surveys of the camp in 2000-2001 are analyzed, with fatal results for the extermination camp hypothesis. The book also documents the general National Socialist policy toward Jews, which never included a genocidal "final solution." 442 pages, b&w illustrations, bibliography, index. (#19)

**The "Extermination Camps" of "Aktion Reinhardt".** By Jürgen Graf, Thomas Kues and Carlo Mattogno. In late 2011, several members of the exterminationist *Holocaust Controversies* blog posted a study online which claims to refute three of our authors' monographs on the camps Belzec, Sobibor and Treblinka (see previous three entries). This tome is their point-by-point response, which makes "mincemeat" out of the bloggers' attempt at refutation. **Caution:** The two volumes of this work are an intellectual overkill for most people. They are recommended only for collectors, connoisseurs and professionals. These two books require familiarity with the above-mentioned books, of which they are a comprehensive update and expansion. 2nd ed., two volumes, total of 1396 pages, illustrations, bibliography. (#28)

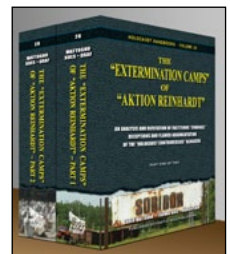
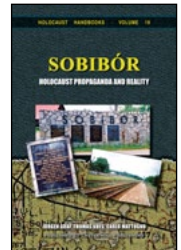
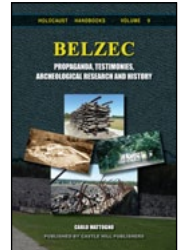
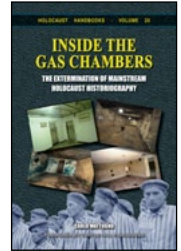
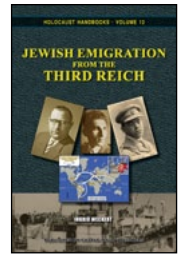

**Chelmno: A Camp in History & Propaganda.** By Carlo Mattogno. At Chelmno, huge masses of Jewish prisoners are said to have been gassed in “gas vans” or shot (claims vary from 10,000 to 1.3 million victims). This study covers the subject from every angle, undermining the orthodox claims about the camp with an overwhelmingly effective body of evidence. Eyewitness statements, gas wagons as extermination weapons, forensics reports and excavations, German documents—all come under Mattogno’s scrutiny. Here are the uncensored facts about Chelmno, not the propaganda. 2nd ed., 188 pages, indexed, illustrated, bibliography. (#23)

**The Gas Vans: A Critical Investigation.** By Santiago Alvarez and Pierre Marais. It is alleged that the Nazis used mobile gas chambers to exterminate 700,000 people. Up until 2011, no thorough monograph had appeared on the topic. Santiago Alvarez has remedied the situation. Are witness statements reliable? Are documents genuine? Where are the murder weapons? Could they have operated as claimed? Where are the corpses? In order to get to the truth of the matter, Alvarez has scrutinized all known wartime documents and photos about this topic; he has analyzed a huge amount of witness statements as published in the literature and as presented in more than 30 trials held over the decades in Germany, Poland and Israel; and he has examined the claims made in the pertinent mainstream literature. The result of his research is mind-boggling. Note: This book and Mattogno’s book on Chelmno were edited in parallel to make sure they are consistent and not repetitive. 398 pages, b&w illustrations, bibliography, index. (#26)

**The Einsatzgruppen in the Occupied Eastern Territories: Genesis, Missions and Actions.** By C. Mattogno. Before invading the Soviet Union, the German authorities set up special units meant to secure the area behind the German front. Orthodox historians claim that these units called *Einsatzgruppen* primarily engaged in rounding up and mass-murdering Jews. This study sheds a critical light into this topic by reviewing all the pertinent sources as well as material traces. It reveals on the one hand that original war-time documents do not fully support the orthodox genocidal narrative, and on the other that most post-“liberation” sources such as testimonies and forensic reports are steeped in Soviet atrocity propaganda and are thus utterly unreliable. In ad-

dition, material traces of the claimed massacres are rare due to an attitude of collusion by governments and Jewish lobby groups. 830 pp., b&w illustrations, bibliography, index. (#39)

**Concentration Camp Majdanek. A Historical and Technical Study.** By Carlo Mattogno and Jürgen Graf. At war’s end, the Soviets claimed that up to two million Jews were murdered at the Majdanek Camp in seven gas chambers. Over the decades, however, the Majdanek Museum reduced the death toll three times to currently 78,000, and admitted that there were “only” two gas chambers. By exhaustively researching primary sources, the authors expertly dissect and repudiate the myth of homicidal gas chambers at that camp. They also critically investigated the legend of mass executions of Jews in tank trenches and prove them groundless. Again they have produced a standard work of methodical investigation which authentic historiography cannot ignore. 3rd ed., 358 pages, b&w illustrations, bibliography, index. (#5)

**Concentration Camp Stutthof and Its Function in National Socialist Jewish Policy.** By Carlo Mattogno and Jürgen Graf. Orthodox historians claim that the Stutthof Camp served as a “make-shift” extermination camp in 1944. Based mainly on archival resources, this study thoroughly debunks this view and shows that Stutthof was in fact a center for the organization of German forced labor toward the end of World War II. 4th ed., 170 pages, b&w illustrations, bibliography, index. (#4)

### SECTION THREE: Auschwitz Studies

**The Making of the Auschwitz Myth: Auschwitz in British Intercepts, Polish Underground Reports and Post-war Testimonies (1941-1947).** By Carlo Mattogno. Using messages sent by the Polish underground to London, SS radio messages sent to and from Auschwitz that were intercepted and decrypted by the British, and a plethora of witness statements made during the war and in the immediate postwar period, the author shows how exactly the myth of mass murder in Auschwitz gas chambers was created, and how it was turned subsequently into “history” by intellectually corrupt scholars who cherry-picked claims that fit into their agenda and ignored or actively covered up literally thousands of lies of “witnesses” to make their narrative look credible. Ca. 300

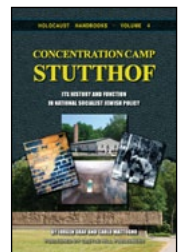
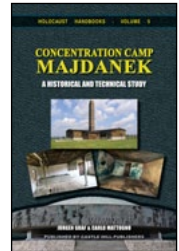
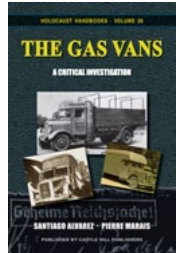
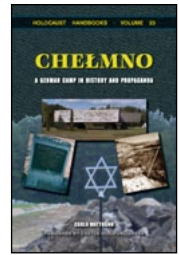



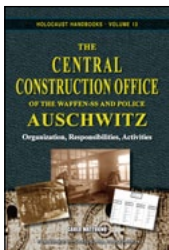
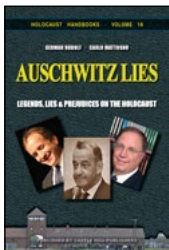
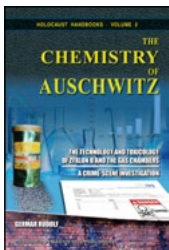
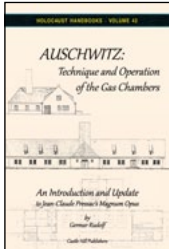
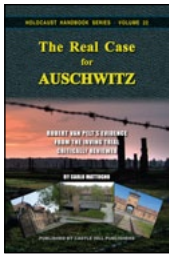

pp., b&w illustrations, bibliography, index. (Scheduled for mid-2020; #41)

**The Real Case of Auschwitz: Robert van Pelt's Evidence from the Irving Trial Critically Reviewed.** By Carlo Mattogno. Prof. Robert van Pelt is considered one of the best mainstream experts on Auschwitz. He became famous when appearing as an expert during the London libel trial of David Irving against Deborah Lipstadt. From it resulted a book titled *The Case for Auschwitz*, in which van Pelt laid out his case for the existence of homicidal gas chambers at that camp. This book is a scholarly response to Prof. van Pelt—and Jean-Claude Pressac, upon whose books van Pelt's study is largely based. Mattogno lists all the evidence van Pelt adduces, and shows one by one that van Pelt misrepresented and misinterpreted each single one of them. This is a book of prime political and scholarly importance to those looking for the truth about Auschwitz. 3rd ed., 692 pages, b&w illustrations, glossary, bibliography, index. (#22)

**Auschwitz: Plain Facts: A Response to Jean-Claude Pressac.** Edited by Germar Rudolf, with contributions by Serge Thion, Robert Faurisson and Carlo Mattogno. French pharmacist Jean-Claude Pressac tried to refute revisionist findings with the “technical” method. For this he was praised by the mainstream, and they proclaimed victory over the “revisionists.” In his book, Pressac's works and claims are shown to be unscientific in nature, as he never substantiate what he claims, and historically false, because he systematically misrepresents, misinterprets and misunderstands German wartime documents. 2nd ed., 226 pages, b&w illustrations, glossary bibliography, index. (#14)

**Auschwitz: Technique and Operation of the Gas Chambers: An Introduction and Update.** By Germar Rudolf. Pressac's 1989 oversize book of the same title was a trail blazer. Its many document reproductions are still valuable, but after decades of additional research, Pressac's annotations are outdated. This book summarizes the most pertinent research results on Auschwitz gained during the past 30 years. With many references to Pressac's epic tome, it serves as an update and correction to it, whether you own an original hard copy of it, read it online, borrow it from a library, purchase a reprint, or are just interested in such a summary in general. 144 pages, b&w illustrations, bibliography. (#42)

**The Chemistry of Auschwitz: The Technology and Toxicology of Zyklon B and the Gas Chambers – A Crime Scene Investigation.** By Germar Rudolf. This study documents forensic research on Auschwitz, where material traces and their interpretation reign supreme. Most of the claimed crime scenes – the claimed homicidal gas chambers – are still accessible to forensic examination to some degree. This book addresses questions such as: What did these gas chambers look like? How did they operate? In addition, the infamous Zyklon B can also be examined. What exactly was it? How does it kill? Does it leave traces in masonry that can be found still today? The author also discusses in depth similar forensic research conducted by other authors. 3rd ed., 442 pages, more than 120 color and almost 100 b&w illustrations, bibliography, index. (#2)

**Auschwitz Lies: Legends, Lies and Prejudices on the Holocaust.** By C. Mattogno and G. Rudolf. The fallacious research and alleged “refutation” of Revisionist scholars by French biochemist G. Wellers (attacking Leuchter's famous report), Polish chemist Dr. J. Markiewicz and U.S. chemist Dr. Richard Green (taking on Rudolf's chemical research), Dr. John Zimmerman (tackling Mattogno on cremation issues), Michael Shermer and Alex Grobman (trying to prove it all), as well as researchers Keren, McCarthy and Mazal (how turned cracks into architectural features), are exposed for what they are: blatant and easily exposed political lies created to ostracize dissident historians. 3rd ed., 398 pages, b&w illustrations, index. (#18)

**Auschwitz: The Central Construction Office.** By C. Mattogno. Based upon mostly unpublished German wartime documents, this study describes the history, organization, tasks and procedures of the one office which was responsible for the planning and construction of the Auschwitz camp complex, including the crematories which are said to have contained the “gas chambers.” 2nd ed., 188 pages, b&w illustrations, glossary, index. (#13)

**Garrison and Headquarters Orders of the Auschwitz Camp.** By C. Mattogno. A large number of all the orders ever issued by the various commanders of the infamous Auschwitz camp have been preserved. They reveal the true nature of the camp with all its daily events. There is not a trace in these orders pointing at anything sinister going on in this camp. Quite to the

contrary, many orders are in clear and insurmountable contradiction to claims that prisoners were mass murdered. This is a selection of the most pertinent of these orders together with comments putting them into their proper historical context. (Scheduled for late 2020; #34)

**Special Treatment in Auschwitz: Origin and Meaning of a Term.** By C. Mattogno. When appearing in German wartime documents, terms like “special treatment,” “special action,” and others have been interpreted as code words for mass murder. But that is not always true. This study focuses on documents about Auschwitz, showing that, while “special” had many different meanings, not a single one meant “execution.” Hence the practice of deciphering an alleged “code language” by assigning homicidal meaning to harmless documents – a key component of mainstream historiography – is untenable. 2nd ed., 166 pages, b&w illustrations, bibliography, index. (#10)

**Healthcare at Auschwitz.** By C. Mattogno. In extension of the above study on *Special Treatment in Auschwitz*, this study proves the extent to which the German authorities at Auschwitz tried to provide health care for the inmates. Part 1 of this book analyzes the inmates’ living conditions and the various sanitary and medical measures implemented. Part 2 explores what happened to registered inmates who were “selected” or subject to “special treatment” while disabled or sick. This study shows that a lot was tried to cure these inmates, especially under the aegis of Garrison Physician Dr. Wirths. Part 3 is dedicated to Dr. this very Wirths. His reality refutes the current stereotype of SS officers. 398 pages, b&w illustrations, bibliography, index. (#33)

**Debunking the Bunkers of Auschwitz: Black Propaganda vs. History.** By Carlo Mattogno. The bunkers at Auschwitz, two former farmhouses just outside the camp’s perimeter, are claimed to have been the first homicidal gas chambers at Auschwitz specifically equipped for this purpose. With the help of original German wartime files as well as revealing air photos taken by Allied reconnaissance aircraft in 1944, this study shows that these homicidal “bunkers” never existed, how the rumors about them evolved as black propaganda created by resistance groups in the camp, and how this propaganda was transformed into a false reality. 2nd ed., 292 pages, b&w ill., bibliography, index. (#11)

**Auschwitz: The First Gassing. Rumor and Reality.** By C. Mattogno. The first gassing in Auschwitz is claimed to have occurred on Sept. 3, 1941, in a basement room. The accounts reporting it are the archetypes for all later gassing accounts. This study analyzes all available sources about this alleged event. It shows that these sources contradict each other in location, date, victims etc, rendering it impossible to extract a consistent story. Original wartime documents inflict a final blow to this legend and prove without a shadow of a doubt that this legendary event never happened. 3rd ed., 190 pages, b&w illustrations, bibliography, index. (#20)

**Auschwitz: Crematorium I and the Alleged Homicidal Gassings.** By C. Mattogno. The morgue of Crematorium I in Auschwitz is said to be the first homicidal gas chamber there. This study investigates all statements by witnesses and analyzes hundreds of wartime documents to accurately write a history of that building. Where witnesses speak of gassings, they are either very vague or, if specific, contradict one another and are refuted by documented and material facts. The author also exposes the fraudulent attempts of mainstream historians to convert the witnesses’ black propaganda into “truth” by means of selective quotes, omissions, and distortions. Mattogno proves that this building’s morgue was never a homicidal gas chamber, nor could it have worked as such. 2nd ed., 152 pages, b&w illustrations, bibliography, index. (#21)

**Auschwitz: Open Air Incinerations.** By C. Mattogno. In spring and summer of 1944, 400,000 Hungarian Jews were deported to Auschwitz and allegedly murdered there in gas chambers. The Auschwitz crematoria are said to have been unable to cope with so many corpses. Therefore, every single day thousands of corpses are claimed to have been incinerated on huge pyres lit in deep trenches. The sky over Auschwitz was covered in thick smoke. This is what some witnesses want us to believe. This book examines the many testimonies regarding these incinerations and establishes whether these claims were even possible. Using air photos, physical evidence and wartime documents, the author shows that these claims are fiction. A new Appendix contains 3 papers on groundwater levels and cattle mass burnings. 2nd ed., 202 pages, b&w illustrations, bibliography, index. (#17)

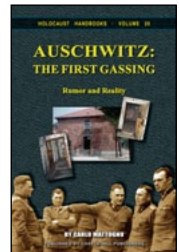
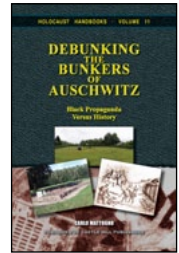
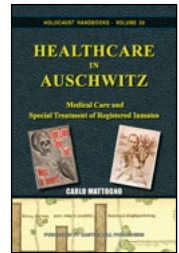
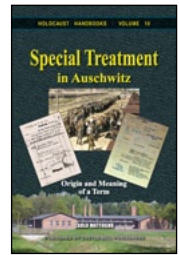

**The Cremation Furnaces of Auschwitz.** By Carlo Mattogno & Franco Deana. An exhaustive study of the history and technology of cremation in general and of the cremation furnaces of Auschwitz in particular. On a vast base of technical literature, extant wartime documents and material traces, the authors can establish the true nature and capacity of the Auschwitz cremation furnaces. They show that these devices were inferior make-shift versions of what was usually produced, and that their capacity to cremate corpses was lower than normal, too. 3 vols., 1198 pages, b&w and color illustrations (vols 2 & 3), bibliography, index, glossary. (#24)

**Curated Lies: The Auschwitz Museum's Misrepresentations, Distortions and Deceptions.** By Carlo Mattogno. Revisionist research results have put the Polish Auschwitz Museum under pressure to answer this challenge. They've answered. This book analyzes their answer and reveals the appallingly mendacious attitude of the Auschwitz Museum authorities when presenting documents from their archives. 248 pages, b&w illustrations, bibliography, index. (#38)

**Deliveries of Coke, Wood and Zyklon B to Auschwitz: Neither Proof Nor Trace for the Holocaust.** By Carlo Mattogno. Researchers from the Auschwitz Museum tried to prove the reality of mass extermination by pointing to documents about deliveries of wood and coke as well as Zyklon B to the Auschwitz Camp. If put into the actual historical and technical context, however, these documents prove the exact opposite of what these orthodox researchers claim. Ca. 250 pages, b&w illust., bibl., index. (Scheduled for 2021; #40)

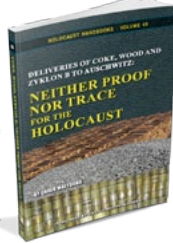

## SECTION FOUR: Witness Critique

**Holocaust High Priest: Elie Wiesel, Night, the Memory Cult, and the Rise of Revisionism.** By Warren B. Rutledge. The first unauthorized biography of Wiesel exposes both his personal deceptions and the whole myth of "the six million." It shows how Zi-

onist control has allowed Wiesel and his fellow extremists to force leaders of many nations, the U.N. and even popes to genuflect before Wiesel as symbolic acts of subordination to World Jewry, while at the same time forcing school children to submit to Holocaust brainwashing. 468 pages, b&w illust., bibliography, index. (#30)

**Auschwitz: Eyewitness Reports and Perpetrator Confessions.** By Jürgen Graf. The traditional narrative of what transpired at the infamous Auschwitz Camp during WWII rests almost exclusively on witness testimony. This study critically scrutinizes the 30 most important of them by checking them for internal coherence, and by comparing them with one another as well as with other evidence such as wartime documents, air photos, forensic research results, and material traces. The result is devastating for the traditional narrative. 372 pages, b&w illust., bibl., index. (#36)

**Commandant of Auschwitz: Rudolf Höss, His Torture and His Forced Confessions.** By Carlo Mattogno & Rudolf Höss. From 1940 to 1943, Rudolf Höss was the commandant of the infamous Auschwitz Camp. After the war, he was captured by the British. In the following 13 months until his execution, he made 85 depositions of various kinds in which he confessed his involvement in the "Holocaust." This study first reveals how the British tortured him to extract various "confessions." Next, all of Höss's depositions are analyzed by checking his claims for internal consistency and comparing them with established historical facts. The results are eye-opening... 402 pages, b&w illustrations, bibliography, index. (#35)

**An Auschwitz Doctor's Eyewitness Account: The Tall Tales of Dr. Mengele's Assistant Analyzed.** By Miklos Nyiszli & Carlo Mattogno. Nyiszli, a Hungarian physician, ended up at Auschwitz in 1944 as Dr. Mengele's assistant. After the war he wrote a book and several other writings describing what he claimed to have experienced. To this day some traditional historians take his accounts seriously, while others reject them as grotesque lies and exaggerations. This study presents and analyzes Nyiszli's writings and skillfully separates truth from fabulous fabrication. 484 pages, b&w illustrations, bibliography, index. (#37)

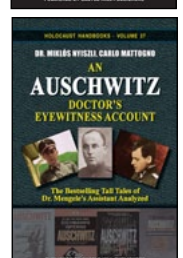
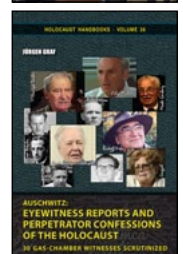
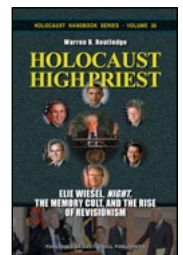
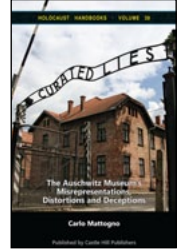
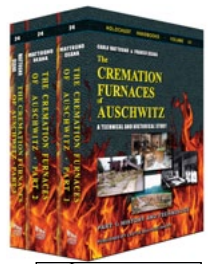

FOR CURRENT PRICES AND AVAILABILITY SEE BOOK FINDER SITES SUCH AS BOOKFINDER.COM, ADDALL.COM, BOOKFINDER4U.COM OR FINDBOOKPRICES.COM; LEARN MORE AT [WWW.HOLOCAUSTHANDBOOKS.COM](http://WWW.HOLOCAUSTHANDBOOKS.COM)  
PUBLISHED BY CASTLE HILL PUBLISHERS, PO Box 243, UCKFIELD, TN22 9AW, UK



# BOOKS BY AND FROM CASTLE HILL PUBLISHERS

Below please find some of the books published or distributed by Castle Hill Publishers in the United Kingdom. For our current and complete range of products visit our web store at [shop.codoh.com](http://shop.codoh.com).

## Thomas Dalton, *The Holocaust: An Introduction*

The Holocaust was perhaps the greatest crime of the 20th century. Six million Jews, we are told, died by gassing, shooting, and deprivation. But: Where did the six million figure come from? How, exactly, did the gas chambers work? Why do we have so little physical evidence from major death camps? Why haven't we found even a fraction of the six million bodies, or their ashes? Why has there been so much media suppression and governmental censorship on this topic? In a sense, the Holocaust is the greatest murder mystery in history. It is a topic of greatest importance for the present day. Let's explore the evidence, and see where it leads.

128 pp. pb, 5"×8", ill., bibl., index

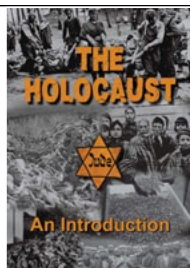

## Carlo Mattogno, *Auschwitz: A Three-Quarter Century of*

### *Propaganda: Origins, Development and Decline of the "Gas Chamber" Propaganda Lie*

During the war, wild rumors were circulating about Auschwitz: that the Germans were testing new war gases; that inmates were murdered in electrocution chambers, with gas showers or pneumatic hammer systems; that living people were sent on conveyor belts directly into cremation furnaces; that oils, grease and soap were made of the mass-murder victims. Nothing of it was true. When the Soviets captured Auschwitz in early 1945, they reported that 4 million inmates were killed on electrocution conveyor belts discharging their load directly into furnaces. That wasn't true either. After the war, "witnesses" and "experts" repeated these things and added more fantasies: mass murder with gas bombs, gas chambers made of canvas; carts driving living people into furnaces; that the crematoria of Auschwitz could have cremated 400 million victims... Again, none of it was true. This book gives an overview of the many rumors, myths and lies about Auschwitz which mainstream historians today reject as untrue. It then explains by which ridiculous methods some claims about Auschwitz were accepted as true and turned into "history," although they are just as untrue.

125 pp. pb, 5"×8", ill., bibl., index, b&w ill.

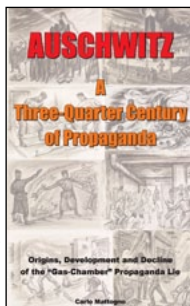

## Wilhelm Stäglich, *Auschwitz: A Judge Looks at the Evidence*

Auschwitz is the epicenter of the Holocaust, where more people are said to have been murdered than anywhere else. At this detention camp the industrialized Nazi mass murder is said to have reached its demonic pinnacle. This narrative is based on a wide range of evidence, the most important of which was presented during two trials: the International Military Tribunal of 1945/46, and the German Auschwitz Trial of 1963-1965 in Frankfurt.

The late Wilhelm Stäglich, until the mid-1970s a German judge, has so far been the only legal expert to critically analyze this evidence. His research reveals the incredibly scandalous way in which the Allied victors and later the German judicial authorities bent and broke the law in order to come to politically foregone conclusions. Stäglich also exposes the shockingly superficial way in which historians are dealing with the many incongruities and discrepancies of the historical record.

3rd edition 2015, 422 pp. pb, 6"×9", b&w ill.

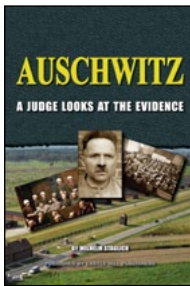

## Gerard Menuhin: *Tell the Truth & Shame the Devil*

A prominent Jew from a famous family says the "Holocaust" is a wartime propaganda myth which has turned into an extortion racket. Far from bearing the sole guilt for starting WWII as alleged at Nuremberg (for which many of the surviving German leaders were hanged) Germany is mostly innocent in this respect and made numerous attempts to avoid and later to end the confrontation. During the 1930s Germany was confronted by a powerful Jewish-dominated world plutocracy out to destroy it... Yes, a prominent Jew says all this. Accept it or reject it, but be sure to read it and judge for yourself!

The author is the son of the great American-born violinist Yehudi Menuhin, who, though from a long line of rabbinical ancestors, fiercely criticized the foreign policy of the state of Israel and its repression of the Palestinians in the Holy Land.

4th edition 2017, 432 pp. pb, 6"×9", b&w ill.

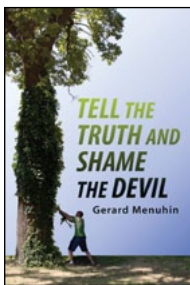

For prices and availability see [www.shop.codoh.com](http://www.shop.codoh.com) or write to: CHP, PO Box 243, Uckfield, TN22 9AW, UK

Robert H. Countess, Christian Lindtner, Germar Rudolf (eds.),

***Exactitude: Festschrift for Prof. Dr. Robert Faurisson***

On January 25, 1929, a man was born who probably deserves the title of the most courageous intellectual of the 20th century and the beginning of the 21st century: Robert Faurisson. With bravery and steadfastness, he challenged the dark forces of historical and political fraud with his unrelenting exposure of their lies and hoaxes surrounding the orthodox Holocaust narrative. This book describes and celebrates the man, who passed away on October 21, 2018, and his work dedicated to accuracy and marked by insubmission.

146 pp. pb, 6"×9", b&w ill.

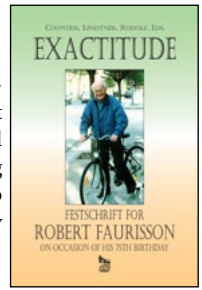

Cyrus Cox, ***Auschwitz – Forensically Examined***

It is amazing what modern forensic crime-scene investigations can find out. This is also true for the Holocaust. There are many big tomes about this, such as Rudolf's 400+ page book on the *Chemistry of Auschwitz*, or Mattogno's 1200-page work on the crematoria of Auschwitz. But who reads those doorstops? Here is a booklet that condenses the most-important findings of Auschwitz forensics into a nutshell, quick and easy to read. In the first section, the forensic investigations conducted so far are reviewed. In the second section, the most-important results of these studies are summarized, making them accessible to everyone. The main arguments focus on two topics. The first centers around the poison allegedly used at Auschwitz for mass murder: Zyklon B. Did it leave any traces in masonry where it was used? Can it be detected to this day? The second topic deals with mass cremations. Did the crematoria of Auschwitz have the claimed huge capacity claimed for them? Do air photos taken during the war confirm witness statements on huge smoking pyres? Find the answers to these questions in this booklet, together with many references to source material and further reading. The third section reports on how the establishment has reacted to these research results.

124 pp. pb., 5"×8", b&w ill., bibl., index

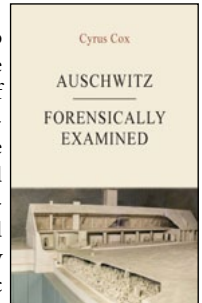

Steffen Werner, ***The Second Babylonian Captivity: The Fate of the Jews in Eastern Europe since 1941***

“But if they were not murdered, where did the six million deported Jews end up?” This is a standard objection to the revisionist thesis that the Jews were not killed in extermination camps. It demands a well-founded response. While researching an entirely different topic, Steffen Werner accidentally stumbled upon the most-peculiar demographic data of Byelorussia. Years of research subsequently revealed more and more evidence which eventually allowed him to substantiate a breathtaking and sensational proposition: The Third Reich did indeed deport many of the Jews of Europe to Eastern Europe in order to settle them there “in the swamp.” This book, first published in German in 1990, was the first well-founded work showing what really happened to the Jews deported to the East by the National Socialists, how they have fared since, and who, what and where they are “now” (1990). It provides context and purpose for hitherto-obscure and seemingly arbitrary historical events and quite obviates all need for paranormal events such as genocide, gas chambers, and all their attendant horrors. With a preface by Germar Rudolf with references to more-recent research results in this field of study confirming Werner's thesis.

190 pp. pb, 6"×9", b&w ill., bibl., index

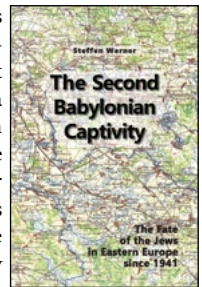

Germar Rudolf, ***Holocaust Skepticism: 20 Questions and Answers about Holocaust Revisionism***

This 15-page brochure introduces the novice to the concept of Holocaust revisionism, and answers 20 tough questions, among them: What does Holocaust revisionism claim? Why should I take Holocaust revisionism more seriously than the claim that the earth is flat? How about the testimonies by survivors and confessions by perpetrators? What about the pictures of corpse piles in the camps? Why does it matter how many Jews were killed by the Nazis, since even 1,000 would have been too many? ... Glossy full-color brochure. PDF file free of charge available at [www.HolocaustHandbooks.com](http://www.HolocaustHandbooks.com), [Option "Promotion"](#). This item is *not* copyright-protected. Hence, you can do with it whatever you want: download, post, email, print, multiply, hand out, sell...

15 pp., stapled, 8.5"×11", full-color throughout

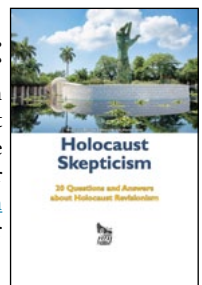

For prices and availability see [www.shop.codoh.com](http://www.shop.codoh.com) or write to: CHP, PO Box 243, Uckfield, TN22 9AW, UK



Germar Rudolf, **Bungled: "Denying the Holocaust"** How Deborah Lipstadt Botched Her Attempt to Demonstrate the Growing Assault on Truth and Memory

With her book *Denying the Holocaust*, Deborah Lipstadt tried to show the flawed methods and extremist motives of "Holocaust deniers." This book demonstrates that Dr. Lipstadt clearly has neither understood the principles of science and scholarship, nor has she any clue about the historical topics she is writing about. She misquotes, mistranslates, misrepresents, misinterprets, and makes a plethora of wild claims without backing them up with anything. Rather than dealing thoroughly with factual arguments, Lipstadt's book is full of *ad hominem* attacks on her opponents. It is an exercise in anti-intellectual pseudo-scientific arguments, an exhibition of ideological radicalism that rejects anything which contradicts its preset conclusions. **F for FAIL**

2nd ed., 224 pp. pb, 5"×8", bibl., index, b&w ill.

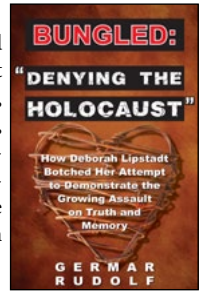

Carolus Magnus, **Bungled: "Denying History"**. How Michael Shermer and Alex Grobman Botched Their Attempt to Refute Those Who Say the Holocaust Never Happened

*Skeptic Magazine* editor Michael Shermer and Alex Grobman from the Simon Wiesenthal Center wrote a book in 2000 which they claim is "a thorough and thoughtful answer to all the claims of the Holocaust deniers." In 2009, a new "updated" edition appeared with the same ambitious goal. In the meantime, revisionists had published some 10,000 pages of archival and forensic research results. Would their updated edition indeed answer all the revisionist claims? In fact, Shermer and Grobman completely ignored the vast amount of recent scholarly studies and piled up a heap of falsifications, contortions, omissions, and fallacious interpretations of the evidence. Finally, what the authors claim to have demolished is not revisionism but a ridiculous parody of it. They ignored the known unreliability of their cherry-picked selection of evidence, utilizing unverified and incestuous sources, and obscuring the massive body of research and all the evidence that dooms their project to failure. **F for FAIL**

162 pp. pb, 5"×8", bibl., index, b&w ill.



Carolus Magnus, **Bungled: "Debunking Holocaust Denial Theories"**. How James and Lance Morcan Botched Their Attempt to Affirm the Historicity of the Nazi Genocide

The novelists and movie-makers James and Lance Morcan have produced a book "to end [Holocaust] denial once and for all." To do this, "no stone was left unturned" to verify historical assertions by presenting "a wide array of sources" meant "to shut down the debate deniers wish to create. One by one, the various arguments Holocaust deniers use to try to discredit wartime records are carefully scrutinized and then systematically disproven." It's a lie. First, the Morcans completely ignored the vast amount of recent scholarly studies published by revisionists; they didn't even identify them. Instead, they engaged in shadowboxing, creating some imaginary, bogus "revisionist" scarecrow which they then tore to pieces. In addition, their knowledge even of their own side's source material was dismal, and the way they backed up their misleading or false claims was pitifully inadequate. **F for FAIL.**

144 pp. pb, 5"×8", bibl., index, b&w ill.

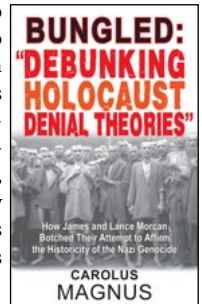

Joachim Hoffmann, **Stalin's War of Extermination 1941-1945**

A German government historian documents Stalin's murderous war against the German army and the German people. Based on the author's lifelong study of German and Russian military records, this book reveals the Red Army's grisly record of atrocities against soldiers and civilians, as ordered by Stalin. Since the 1920s, Stalin planned to invade Western Europe to initiate the "World Revolution." He prepared an attack which was unparalleled in history. The Germans noticed Stalin's aggressive intentions, but they underestimated the strength of the Red Army. What unfolded was the most-cruel war in history. This book shows how Stalin and his Bolshevik henchman used unimaginable violence and atrocities to break any resistance in the Red Army and to force their unwilling soldiers to fight against the Germans. The book explains how Soviet propagandists incited their soldiers to unlimited hatred against everything German, and he gives the reader a short but extremely unpleasant glimpse into what happened when these Soviet soldiers finally reached German soil in 1945: A gigantic wave of looting, arson, rape, torture, and mass murder...

428 pp. pb, 6"×9", bibl., index, b&w ill.

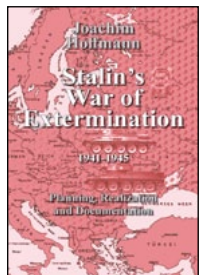

## Udo Walendy, *Who Started World War II: Truth for a War-Torn World*

For seven decades, mainstream historians have insisted that Germany was the main, if not the sole culprit for unleashing World War II in Europe. In the present book this myth is refuted. There is available to the public today a great number of documents on the foreign policies of the Great Powers before September 1939 as well as a wealth of literature in the form of memoirs of the persons directly involved in the decisions that led to the outbreak of World War II. Together, they made possible Walendy's present mosaic-like reconstruction of the events before the outbreak of the war in 1939. This book has been published only after an intensive study of sources, taking the greatest care to minimize speculation and inference. The present edition has been translated completely anew from the German original and has been slightly revised.

500 pp. pb, 6"×9", index, bibl., b&w ill.

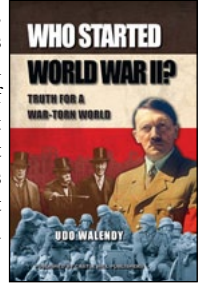

## Germar Rudolf: *Resistance is Obligatory!*

In 2005 Rudolf, a peaceful dissident and publisher of revisionist literature, was kidnapped by the U.S. government and deported to Germany. There the local lackey regime staged a show trial against him for his historical writings. Rudolf was not permitted to defend his historical opinions, as the German penal law prohibits this. Yet he defended himself anyway: 7 days long Rudolf held a speech in the court room, during which he proved systematically that only the revisionists are scholarly in their attitude, whereas the Holocaust orthodoxy is merely pseudo-scientific. He then explained in detail why it is everyone's obligation to resist, without violence, a government which throws peaceful dissident into dungeons. When Rudolf tried to publish his public defence speech as a book from his prison cell, the public prosecutor initiated a new criminal investigation against him. After his probation time ended in 2011, he dared publish this speech anyway...

2nd ed. 2016, 378 pp. pb, 6"×9", b&w ill.

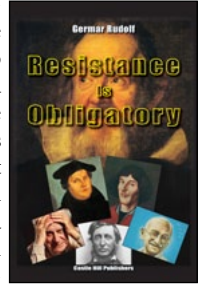

## Germar Rudolf, *Hunting Germar Rudolf: Essays on a Modern-Day Witch Hunt*

German-born revisionist activist, author and publisher Germar Rudolf describes which events made him convert from a Holocaust believer to a Holocaust skeptic, quickly rising to a leading personality within the revisionist movement. This in turn unleashed a tsunami of persecution against him: loss of his job, denied PhD exam, destruction of his family, driven into exile, slandered by the mass media, literally hunted, caught, put on a show trial where filing motions to introduce evidence is illegal under the threat of further prosecution, and finally locked up in prison for years for nothing else than his peaceful yet controversial scholarly writings. In several essays, Rudolf takes the reader on a journey through an absurd world of government and societal persecution which most of us could never even fathom actually exists...

304 pp. pb, 6"×9", bibl., index, b&w ill.

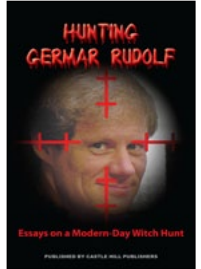

## Germar Rudolf, *The Day Amazon Murdered History*

Amazon is the world's biggest book retailer. They dominate the U.S. and several foreign markets. Pursuant to the 1998 declaration of Amazon's founder Jeff Bezos to offer "the good, the bad and the ugly," customers once could buy every book that was in print and was legal to sell. However, in early 2017, a series of anonymous bomb threats against Jewish community centers occurred in the U.S., fueling a campaign by Jewish groups to coax Amazon into banning revisionist writings, false portraying them as anti-Semitic. On March 6, 2017, Amazon caved in and banned more than 100 books with dissenting viewpoints on the Holocaust. In April 2017, an Israeli Jew was arrested for having placed the fake bomb threats, a paid "service" he had offered for years. But that did not change Amazon's mind. Its stores remain closed for history books Jewish lobby groups disapprove of. This book accompanies the documentary of the same title. Both reveal how revisionist publications had become so powerfully convincing that the powers that be resorted to what looks like a dirty false-flag operation in order to get these books banned from Amazon...

128 pp. pb, 5"×8", bibl., b&w ill.



FOR CURRENT PRICES AND AVAILABILITY SEE BOOK FINDER SITES SUCH AS WWW.BOOKFINDER.COM, WWW.ADDALL.COM, WWW.BOOKFINDER4U.COM OR WWW.FINDBOOKPRICES.COM; LEARN MORE AT SHOP.CODOH.COM. PUBLISHED BY CASTLE HILL PUBLISHERS, PO BOX 243, UCKFIELD, TN22 9AW, UK

## Thomas Dalton, *Hitler on the Jews*

That Adolf Hitler spoke out against the Jews is beyond obvious. But of the thousands of books and articles written on Hitler, virtually none quotes Hitler's exact words on the Jews. The reason for this is clear: Those in positions of influence have incentives to present a simplistic picture of Hitler as a blood-thirsty tyrant. However, Hitler's take on the Jews is far more complex and sophisticated. In this book, for the first time, you can make up your own mind by reading nearly every idea that Hitler put forth about the Jews, in considerable detail and in full context. This is the first book ever to compile his remarks on the Jews. As you will discover, Hitler's analysis of the Jews, though hostile, is erudite, detailed, and – surprise, surprise – largely aligns with events of recent decades. There are many lessons here for the modern-day world to learn.

200 pp. pb, 6"×9", index, bibl.



## Thomas Dalton, *Goebbels on the Jews*

From the age of 26 until his death in 1945, Joseph Goebbels kept a near-daily diary. From it, we get a detailed look at the attitudes of one of the highest-ranking men in Nazi Germany. Goebbels shared Hitler's dislike of the Jews, and likewise wanted them totally removed from the Reich territory. Ultimately, Goebbels and others sought to remove the Jews completely from the Eurasian land mass—perhaps to the island of Madagascar. This would be the “final solution” to the Jewish Question. Nowhere in the diary does Goebbels discuss any Hitler order to kill the Jews, nor is there any reference to extermination camps, gas chambers, or any methods of systematic mass-murder. Goebbels acknowledges that Jews did indeed die by the thousands; but the range and scope of killings evidently fall far short of the claimed figure of 6 million. This book contains, for the first time, every significant diary entry relating to the Jews or Jewish policy. Also included are partial or full citations of 10 major essays by Goebbels on the Jews.

274 pp. pb, 6"×9", index, bibl.



## Thomas Dalton, *The Jewish Hand in the World Wars*

For many centuries, Jews have had a negative reputation in many countries. The reasons given are plentiful, but less well known is their involvement in war. When we examine the causal factors for war, and look at its primary beneficiaries, we repeatedly find a Jewish presence. Throughout history, Jews have played an exceptionally active role in promoting and inciting war. With their long-notorious influence in government, we find recurrent instances of Jews promoting hardline stances, being uncompromising, and actively inciting people to hatred. Jewish misanthropy, rooted in Old Testament mandates, and combined with a ruthless materialism, has led them, time and again, to instigate warfare if it served their larger interests. This fact explains much about the present-day world. In this book, Thomas Dalton examines in detail the Jewish hand in the two world wars. Along the way, he dissects Jewish motives and Jewish strategies for maximizing gain amidst warfare, reaching back centuries.

197 pp. pb, 6"×9", index, bibl.



## Barbara Kulaszka (ed.), *The Second Zündel Trial: Excerpts from the Transcript*

In 1988, German-Canadian Ernst Zündel was for on trial a second time for allegedly spreading “false news” about the Holocaust. Zündel staged a magnificent defense in an attempt to prove that revisionist concepts of “the Holocaust” are essentially correct. Although many of the key players have since passed away, including Zündel, this historic trial keeps having an impact. It inspired major research efforts as expounded in the series *Holocaust Handbooks*. In contrast to the First Zündel Trial of 1985, the second trial had a much greater impact internationally, mainly due to the *Leuchter Report*, the first independent forensic research performed on Auschwitz, which was endorsed on the witness stand by British bestselling historian David Irving. The present book features the essential contents of this landmark trial with all the gripping, at-times-dramatic details. When Amazon.com decided to ban this 1992 book on a landmark trial about the “Holocaust”, we decided to put it back in print, lest censorship prevail...

498 pp. pb, 8.5"×11", bibl., index, b&w ill.

