

ASSORTED NASTIES



DAVID HARBER

Assorted Nasties

by

David Harber



Desert Publications
El Dorado, AR 71731-1751

Assorted Nasties

by

David Harber

1993 by David Harber

Published by Desert Publications
P.O.Box 1751
El Dorado, AR 71731-1751
501-862-2077

ISBN 0-87947231-6
10 9 8 7 6 5 4 3 2
Printed in U. S. A.

Desert Publication is a division of
The DELTA GROUP. Ltd.

Direct all inquiries & orders to the above address.

All rights reserved. Except for use in a review, no portion of this book may be reproduced by any means known or unknown without the express written permission of the publisher.

Neither the author nor the publisher assumes any responsibility for the use or misuse of the information contained in this book.

Introduction

In the late 1950's, the CIA was alleged to have commissioned a book which was to detail the construction and utilization of various chemical and biological weapons. Barry Rothman, the brilliant, if somewhat eccentric, scientist who developed the U.S. Army's Improvised Munitions Handbooks, was set to the task. The result is the now legendary "Devil's Diary". Though no copies are known to have survived the CIA purges of the mid- 1970's, this book is a humble effort to recreate the original work, using both the cryptic clues that Rothman left before his death, and a thorough search of the available literature. It is the culmination of five years research in the field, including items unavailable or undiscovered when the original was compiled. This book will cover a myriad of lethal materials, ranging from those which may be cooked up (literally) in the kitchen, to those requiring a sophisticated lab setup. Most, however, are not beyond the range of anyone familiar with proper laboratory technique. The only difference will be that there are no biological agents listed. They are of limited utility and too potentially dangerous to prepare without very special skills and equipment. Special attention must always be paid to safety. The substances you will be working with are lethal in the extreme. Some will penetrate the skin, emit noxious vapors, or are fatal in sub-milligram doses. A few require special chemicals which are known carcinogens or are pyrophoric (ignite spontaneously upon contact with air). All must be treated with the utmost caution and respect. The basic safety equipment for working with these materials

are surgical rubber gloves and a dust mask. These will provide protection against most of the toxins. In some cases, however, special equipment such as a chemical decontamination suit, military gas mask, or sealed glove box will be necessary. A well constructed glove box with an efficient filter and fume exhaust is an invaluable piece of equipment and well worth the expense of purchasing or trouble of construction.

Some commercially available examples also have a provision for working in an inert atmosphere. Just as important is a thorough knowledge of the hazards inherent to the chemicals involved. All should be checked out in the "Merck Index", as a *minimum* precaution. If the chemical are purchased from a chemical supply house, they can provide you with a "Product Safety Data Sheet", upon request. An excellent reference work for all things chemical is the "Chemical Technician's Ready Reference Handbook", available at most technical book stores. Careful study of this book, with a little lab practice, can teach *anyone* of average intelligence to perform the techniques necessary for all but the most complex chemical synthesis. It is highly recommended.

SPECIAL NOTE- No illustrations of the various toxic plants and fungi are provided. Black and white photographs or drawings are generally inadequate for proper identification. Any decent bookstore or library has books on poisonous plants with color illustrations. *Use* one of these as your guide.

Dedication

To the memory of my friend John A. Minnery.
The only one who thought that this book
would (or indeed, should) ever be published.

Warning

The information presented here has the potential of being extremely dangerous. Under no circumstances does the author or publisher advocate attempts to produce the products describe herein or the use thereof. The data is for educational purposes and should not be used otherwise. Neither the author or publisher assumes any responsibility for the use or misuse of the contents of this book.

Table of Contents

Toxins

| | |
|-----------------------------------|----|
| Aconitine..... | 1 |
| Aflatoxins..... | 5 |
| Amanita Toxins..... | 9 |
| Arsenic Trioxide..... | 11 |
| Arsine..... | 12 |
| Batrachotoxins..... | 13 |
| Chloracetorte..... | 17 |
| Colchicine..... | 21 |
| Coniine..... | 25 |
| Coyotoxin..... | 29 |
| Cyanides..... | 31 |
| Dimethyl Sufate..... | 41 |
| Dimethyl Sulfoxide..... | 43 |
| Fentanyl..... | 45 |
| Homebrew Nerve Gas..... | 47 |
| Mustard Gas..... | 49 |
| Nicotine..... | 57 |
| Ricin..... | 61 |
| Sarin..... | 67 |
| Sodium Pentothal, Thiopental..... | 71 |
| Telrodotoxin..... | 73 |
| VX..... | 77 |

| | | |
|---------------------------------|------------------|-----|
| | Delivery Systems | |
| Introduction..... | | 81 |
| Poison Bullet #1..... | | 85 |
| Poison Bullet #2..... | | 89 |
| Poison Bullet #3..... | | 93 |
| Toxic Smoke Grenade..... | | 97 |
| Contact Poison Applicator..... | | 101 |
| MiniFang..... | | 105 |
| HCN Projector..... | | 109 |
| Silent Sleeve Gun..... | | 115 |
| Capture Piston Pipe Pistol..... | | 125 |
| Pocket Crossbow..... | | 131 |
| Blowguns..... | | 135 |



SOURCE Roots of *Aconitum napellus*, *A. Columbianum*, *A. ferox*, and many others. Also present in seeds and, in small amounts, in all other parts of the plant.

MOLECULAR WEIGHT- (W)645.72

FORM- Yellowish-white amorphous powder with an intensely bitter taste.

HANDLING - Avoid inhalation, ingestion and skin contact. This alkaloid is percutaneous - it can be absorbed through the skin.

DOSAGE - 100mg would be sufficient for most people. Crystalline aconitine is 10 to 15 times more toxic than the amorphous form, with a lethal dose as low as 4mg.

SYMPTOMS - Taken orally, the symptoms usually begin within a few minutes, though they may be delayed an hour or so. There is first numbing and tingling of the face and mouth that later spreads to the entire body. Vomiting usually, but not always, occurs. There is dizziness, muscular weakness, loss of speech, cardiac irregularities, and finally heart failure. Large doses may cause quick death by shock, but death usually occurs between 8 minutes to 4 hours after ingestion.

DETAILS - The powdered root of the aconite plants have been used *as* a poison since the time of the ancient

Assorted Nasties

Greeks. The plant is known worldwide by a variety of names such as Wolfsbane, Monkshood, and Friar's Cap. The most potent variety is *A. ferox* or Indian Aconite, which grows only in northern India. This particular species is so poisonous that handling it with the bare hands can cause serious, though probably not fatal, poisoning.

Therefore, gloves should always be worn when harvesting any aconites. The plant is most poisonous just prior to flowering. The Delphinium or Larkspur plant also contains aconitine, along with delphinine, an alkaloid of similar toxicity. The Soviets used n .32 caliber bullet during WWII which contained 20 to 30 mg of aconitine. The Germans captured a number of these cartridges in 1944 and decided to test them, using their unlimited supply of condemned "criminals"*. Five prisoners were shot once in the upper thigh and their reactions observed. For 20 to 25 minutes nothing untoward happened, then they began experiencing heavy salivation and vomiting, progressing to convulsions and finally death about 2 hours after they were shot. These bullets contained the crystalline form which is the most deadly, especially when heated to high temperature as it is in a bullet. It also emits highly toxic fumes when heated.

Aconitine is soluble in alcohol, ether and chloroform. It is only slightly soluble in water.

Aconitine Production

1) Line the basket of a percolator with filter paper and fill with powdered aconite root until it is half full.

2) Fill the percolator itself half full of a mixture of one part amyl alcohol and three parts methanol. Percolate for 30 minutes. 'Do this in a well-ventilated area. Methanol fumes are both poisonous and flammable;.

3) Drain off the alcohol, add the same amount of fresh alcohol mixture to the percolator and repeat step 2.

4) Drain off the alcohol. Take a small pinch of the powder from the basket and allow it to dry thoroughly. When dry, taste a tiny amount of the powder. If it numbs the tongue, repeat the extraction. If not, discard the powder and proceed to step 5. (Tasting a small amount of the powder will not harm you, but be sure not to swallow it and rinse your mouth out several times afterwards).

5) Combine the alcohol extracts. Pour them into a distilling flask until it is about half full. Hook up an aspirator to provide vacuum and distill gently until the flask has only one quarter of the original volume left.

6) Add this to a bottle of 1% sulfuric acid and shake for several minutes. There should be at least five times as much acid solution as alcohol extract.

7) Add this liquid to a separatory funnel with an equal volume of ethyl ether and shake for several minutes.

8) Drain the bottom (water) layer and save. Discard the upper (ether) layer.

9) Add dilute ammonia until the pH is alkaline (8 or higher).

10) Add this liquid to a separatory funnel with an equal volume of ethyl ether and shake, for several minutes.

11) Drain the bottom (water) layer and discard. Add a small quantity of cold water to the funnel and shake. Drain the water and discard.

12) Evaporate the ether in a well-ventilated area away from any source of sparks. Ether fumes are explosive.

13) Add the residue to a small amount of hot water, filter, and place in a refrigerator overnight to crystallize.

14) Filter this solution and dry the powder. Store in an airtight bottle.



SOURCE - Extracted from mold cultures of *aspegillus flavus*.

FORM - Colorless crystals when pure.

HANDLING Should always be handled in a sealed glove box due to its extreme toxicity and carcinogenic nature.

DOSAGE - One milligram (depends on purity of compound).

SYMPTOMS - Loss of appetite, weakness in the limbs. Autopsy reveals hemorrhage and necrosis of the liver and engorgement of the kidneys. Identical to the progressive damage caused by excessive drinking.

DETAILS - Aflatoxins are the poisonous product of a group of polynuclear molds that grow on peanuts, corn and in cottonseed meal. They are responsible for the "Turkey X" disease which occasionally devastates the poultry industry. The presence of the mold doesn't always indicate presence of the toxin. Toxin production is dependent on various factors such as moisture and temperature. There are two basic types of aflatoxins, both of which are fluorescent under UV (black) light. Once the mold has been identified, the UV light is an excellent way to check for toxin production. Aflatoxin B glows blue, while Aflatoxin G glows

Assorted Nasties

green. If at all possible, aflatoxins should only be handled in liquid form, that is, dissolved in alcohol, when outside of the glove box. The pure toxin is fatal at a dosage of .0063 mg per kilogram of body weight and is a potent carcinogen in lower doses. Death usually occurs in about one week. Something this powerful should be treated with the utmost caution and respect. The hardest part of aflatoxin production is finding a suitable mold culture to use as a starter. A field expedition is in order. A good microbiology handbook will yield helpful hints on locating and identifying the mold.

Aflatoxin Production

- 1) Sterilize 150 grams of shredded wheat in a oven at 100 C for one hour. Take care to prevent scorching. At the same time, sterilize a one-gallon glass jug or 4 liter boiling flask. The latter is preferred.
- 2) Wear a dust mask, shower cap and clean clothes. Wash the work area down with disinfectant before starting work and make sure the room has no drafts.
- 3) When both are cool, stuff the shredded wheat into the jug or flask and wet with 1/3 cup of distilled water.
- 4) Inoculate with *A. flavus* culture, cap with a wad of sterile cotton, and incubate at 30 C° for 7 to 9 days. Be careful not to contaminate the media with any other organisms.
- 5) Add 750 ml of chloroform to the jug and swirl to rinse out the wheat and any mold formations. Reflux on a steam bath for 10 minutes. Take care to avoid contaminating the work area with spores. Always wear your dust mask. Note - if a 4 liter boiling flask is used to grow the culture it may be refluxed in same. If not, then remove the culture in portions and reflux in a smaller flask. This, however, exposes you to unnecessary danger and should be avoided if at all possible.
- 6) Cool to room temperature and filter through two coffee filters.

7) Refilter through a coffee filter containing 400 grams of anhydrous (totally dry) sodium sulfate.

8) Repeat extraction with two more 750 ml portions of chloroform.

9) Combine extracts and evaporate to a volume of approximately 10 ml on a steam bath under a stream of nitrogen.

10) Add residue to 200 ml of petroleum ether, slowly, with vigorous stirring to precipitate the toxin.

11) Cool to 5 C° and filter through a small Buchner funnel. Yield is about 500 mg of crude aflatoxins with a purity of 50 to 60 %. It may be used as is or further purified using liquid chromatography. This, however, is generally unnecessary for most users of the toxin.



SOURCE - Certain mushrooms of the Amanita family.

FORM Yellowish-white powder or crystals. Soluble in water, ethanol, and methanol.

HANDLING - Avoid ingestion and inhalation.

DOSAGE - 100mg, ingested.

SYMPTOMS - Onset varies from 30 minutes to 24 hours. They begin with vomiting, diarrhea, stomach pain, and cold sweats. The victim begins to weaken, heartbeat becomes irregular, and after 2 to 3 days, he lapses into a coma. Death usually follows in 5 to 10 days, depending on the dosage. If he improves on the third day, recovery is likely. If he remains the same or worsens, death will soon occur.

DETAILS - The toxicity of certain amanita mushrooms has been well known for centuries. The main toxic species in the United States are Amanita phalloides (Deathcup or Destroying Angel), A. verna, and A. virosa. They contain a mixture of the toxins amanitin, phalloidin, and phalloin. Heat weakens or destroys the toxins, as evidenced by the fact that fresh pressed Amanita juice is three times more toxic than the boiled juice. There is no antidote for these toxins - treatment is largely symptomatic. The liver is the main target and is virtually destroyed upon short

exposure. Lately there has been some success with using liver transplants to repair amanita damage. You win some, you lose some. The fatality rate in naturally occurring cases is 55%. The most vital piece of information to a doctor treating a poison victim is what toxin was ingested. If a victim is known to have eaten wild mushrooms, it makes their job a lot easier. An unknown toxin introduced by unknown means is very difficult to treat. Since you will have to gather the mushrooms in the wild, a good handbook with color pictures is invaluable. Simon and Schuster's "Mushroom Field Guide", is one of the best and highly recommended.

Amanita Toxin Extraction

1) Place fresh mushrooms on a screen rack and either air dry, or dry in an oven at the lowest temperature. Make sure you don't scorch them.

2) Place the dried mushrooms in a blender and grind into a powder.

3) Cover the powder with five times as much methanol and blend for five minutes. Allow the powder to soak in the blender for about three days, turning on the machine for five minutes every twelve hours or so.

4) Filter the solution and discard the solids.

5) Place the solution in a shallow dish and allow the alcohol to evaporate.

6) Scrape the gummy residue off the dish and dissolve in the minimum amount of pentane.

7) Filter this solution and discard the solids.

8) Place the solution in a shallow dish and evaporate the pentane. The crystals recovered are a mixture of the main three toxins. Steps 7 and 8 may be repeated, if desired, for further purification.

Note - Remember to perform all evaporation in a well-ventilated area, as both pentane and methanol have fumes which are hazardous and flammable.



SOURCE - Chemical supply house in pure form. Also available in some insecticides at various strengths.

MOLECULAR WEIGHT- (197.82)

FORM - White crystalline powder. Odorless and tasteless, but seems to have a somewhat gritty texture in the mouth. The more finely powdered, the more effective it is.

DOSAGE - Varies with the individual, between 100 mg and 1 gram for most people.

SYMPTOMS - Painful vomiting and diarrhea, after a delay of up to an hour or so, eventual collapse of the central nervous system. Ingestion of a large quantity of arsenic, which is rapidly absorbed, and especially if alcohol is also consumed, produces paralytic poisoning, the most dangerous form of arsenic intoxication. This causes depression of the CNS and quick death. Caution should be used as large doses may cause vomiting before it can be absorbed.

DETAILS - Arsenic has been in use for centuries. It was a special favorite of the great Renaissance poisoners of the Venetian school. Cesare Borgia's favorite tool was an arsenic compound he called "La Cantarella". First he poisoned a sow with a heavy dose of arsenic, removed its internal organs, and

covered them with more arsenic. As the organs putrefied, a liquid flowed from them which was collected and evaporated. The white powder left over was La Cantarella, a biologically concentrated arsenic compound. Although it has been possible to detect arsenic in an autopsy since the early 1800's, it still occasionally slips by the coroner. This usually occurs when small doses have been administered over a period of time, which can simulate several progressive illnesses. Surprisingly, it is difficult to detect arsenic in a living person.

Toxin • Arsine Gets

SOURCE - High temperature decomposition of arsenic trioxide. Also used in some industrial chemical processes.

FORM Colorless gas with a strong garlic odor.

HANDLING - Avoid inhalation.

DOSEAGE - 300 ppm (parts per million - a measure of gas concentration in the air) causes death in 5 to 10 minutes. Heavier concentrations are quicker.

SYMPTOMS - First there is a vague feeling of discomfort, faintness, burning sensation in the face, severe headache and nausea, continuous vomiting, choking, and severe pain. Death is due to depression of the central nervous system.

DETAILS - Arsine is a common by-product of many chemical industries. The Lewisite gas used in WW1 was a form of arsine. The weapons section has a gas grenade which generates arsine. Arsine is at its best when used in enclosed areas in heavy concentration. Death from this type of exposure is remarkably quick as the *gas* shuts down the central nervous system in a matter of seconds.

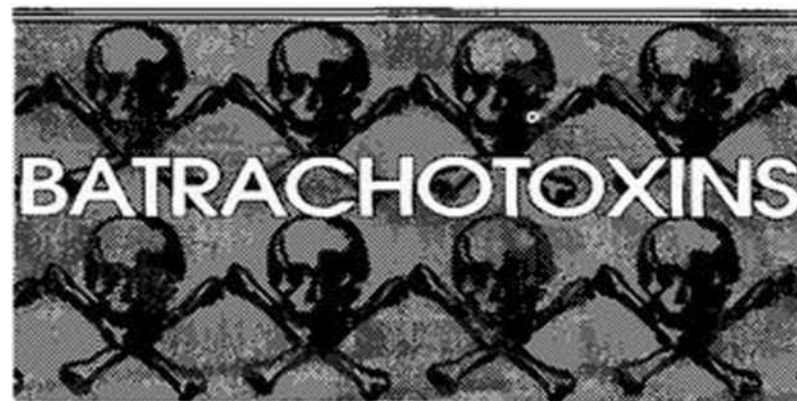

SOURCE - Extracted from skins of various species of South American and Central American frogs.

FORM - Pure: colorless crystals. Crude: Whitish powder.

HANDLING - Avoid unnecessary contact.

DOSAGE Pure - 0.2mg IV. Crude - 2mg IV. Harmless orally, unless ulcers are present or there are sores in the mouth.

SYMPTOMS - Salivation, constricted throat, spasms, paralysis, and death.

DETAILS - Batrachotoxins are the powerful steroid venoms extracted from the skin of various species of frogs (*Phyllobates terribilis*, *P. aurotaenia*, *P. bicolor*, *Dendrobates pumilio*, etc.). It is the most powerful animal venom known, being almost ten times as deadly as Tetrodotoxin. It is used by various Indian tribes as an arrow poison. The poison is exuded by the frog when under stress of heat or pain. The Indians would impale the frog on a stick and hold it over a fire. The venom would form droplets, like sweat beads, on its skin, which would then be either scraped off and stored, or they would roll the points of their darts in it. One frog was said to provide enough poison for up to 50 hunting darts. For some unknown reason, possibly the lack of natural en-

emies, specimens kept in captivity slowly lose their toxicity over time and their *offspring* may exhibit no toxicity at all. It has been observed that a frog suffering from extreme stress before dying regained the full potency of its venom. The venom must be extracted while the frog is alive or soon after death, as enzyme action begins to destroy the toxin. The Japanese use a technique of placing toads in an electric cage to produce their highly prized aphrodisiac "sweat of toad". Due to the scarcity of the frogs and their possibly limited supply, this should be investigated. Toxicity varies with the species of frog, the most poisonous being the bright yellow "Phyllobatesterribilis", which lives in a small area near the Saija river in western Columbia. It is at least 20 times more toxic than any other species.

NOTE - An excellent reference on the frogs is the February 1983 issue of Scientific American, which contains the article "Dart-Poison Frogs", by Charles W. Myers and John W. Daly. It includes color plates of the frogs and maps showing their various habitats.

Batrachotoxin Extraction

1) The frogs are killed with ether and carefully skinned using forceps and scissors. The skin is then cut into small pieces and soaked in methanol at a proportion of 500 ml per 250 frog skins.

2) Place the methanol and skins in a blender and blend at high speed for 5 minutes. Filter the solution and repeat twice more with fresh methanol. Discard the skins when done.

3) Concentrate the methanol extracts under vacuum at 30 * C until they are one-third their original volume.

4) Chill the solution to 5 * C and dilute with three times as much distilled water. All subsequent extractions will be done at 5 ' C.

5) Extract the aqueous methanol solution three times with equal volumes of chloroform. This is done by shaking in a separatory funnel.

6) The chloroform solutions are combined and extracted four times with one-half volumes of cold 0.1N hydrochloric acid (HCl).

7) These acidic extracts are adjusted to pH 9-10 using 1.0N ammonium hydroxide and extracted three times with equal volume of chloroform.

8) The chloroform extracts are combined, dried over sodium sulfate, and concentrated under vacuum until dry. The residue will be crude, a mixture of about three different alkaloids. Yield will depend on the species of the frogs used. In one test, 5000 adult *Phyllobates aurotaenia* yielded 157 mg of mixed alkaloids, while 750 adult *Dendrobates tricolor* yielded 80 mg.



SOURCE - Chemical synthesis.

FORM - Clear liquid with pungent odor like hydrogen chloride. Very volatile.

HANDLING - Keep container tightly closed and avoid contact with vapor.

DOSAGE - Causes severe tearing in the eyes at a concentration as low as 0.018 mg/liter. 0.10 mg/L is intolerable after one minute and exposure to 2.30 mg/L is lethal after ten minutes.

SYMPTOMS - Lachrimator (tear gas) - severe tearing and burning of the eyes.

DETAILS - Chloracetone is one of the early tear gases used in WWI. Though extremely effective, it has a tendency to polymerize (break down into inert substances) on long storage and so has fallen into disuse. Addition of a small percentage of hydroquinone (a common photographic chemical) may help to prevent this. Barring this, it should be freshly prepared to prevent breakdown. As it is so easy to make and the materials so widely available, it should find many uses in tactical planning. Any gas mask containing charcoal will efficiently filter it out. Sealed bottles which will burst on impact are the easiest way to use this material. Attaching a firecracker with a delay fuse (a cigarette slipped

over the fuse, for instance) to the bottle will provide getaway time during harassment actions.

Chloracetone Production

1) Set up a gas generation bottle containing 100 grams of calcium hypochlorite (HTH) Attach the gas tube to an aerator placed in the bottom of a 250 ml flask of acetone (see drawing).

2) Begin addition of a mixture of half muriatic acid **and** half water into the gas jar in a slow stream. A total of 200 grams of this acid mix will be needed. The yellowish-green chlorine gas will begin generating. If not, a gentle application of heat to the generating flask should *got* things going.

3) When all of the gas has been generated, check the specific gravity of the acetone with a hydrometer. If it reads at least 1.16 then the process is complete. If not, repeat the gas generation step with about 1/4 of the amount previously used. Recheck with the hydrometer.

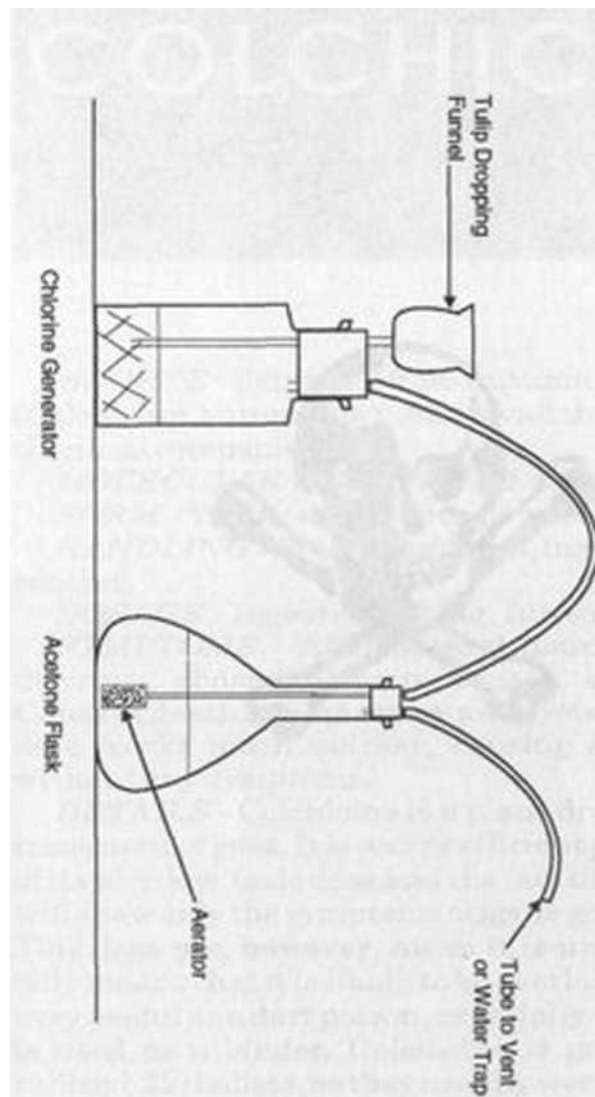

Chloracetone Production



SOURCE - Extracted from Autumn Crocus flower (*Colchicum autumnale*). Also available from many chemical companies.

MOLECULAR WEIGHT - 399.43

FORM - Yellow amorphous powder.

HANDLING - Avoid inhalation, ingestion, or skin contact.

DOSAGE - Ingested - 20 mg. Intravenous - 2 mg.

SYMPTOMS - After several hours (ingested) - diarrhea, abdominal pain, nausea, and vomiting. Cause of death is respiratory paralysis. Intravenous dose works much quicker, causing sudden death without any symptoms.

DETAILS - Colchicine is a plant drug used in the treatment of gout. It is a very efficient poison in view of its very low toxic dose and the fact that an autopsy will show only the symptoms of acute gastroenteritis. This does not, however, mean it is undetectable. It only means that it is likely to be overlooked. It is also very useful as a dart poison, especially when nicotine is used as a binder. Colchicine is great for small caliber (.22) bullets, as they usually won't hold enough of most other poisons to do any good. It dissolves slowly in water, but faster in dilute ethanol (liquor). As with any plant alkaloid, it is best to harvest the

Autumn Crocus just before flowering, when the alkaloid content is at its highest. If you do not choose the extraction route, any decent chemical supply house will carry it. I had a chemical house refuse to sell me potassium cyanide but who had no problems with selling me all the colchicine I wanted (at \$30.00 a gram). Colchicine is at least 5 times as deadly as cyanide. It's a funny world.

Colchicine has also been used by the drug culture to induce genetic mutations in the cannabis plant and thus, increase its potency. The seeds from the mutated plants are harvested and sown to grow a new and more potent crop. If marijuana from the original plant is smoked, fatalities are possible and, indeed, likely to occur. At least a dozen cases of colchicine poisoning from this source are on record. The fatal dose is unknown but is certainly less than the 20 mg oral dose. To utilize this induction route, dissolve the dose of colchicine in the minimum amount of alcohol and drip it into the open end of a cigarette. Care should be taken to avoid discoloring or altering the appearance of the cigarette in any way. It is best to use a hypodermic syringe or similar apparatus to place the dose midway in the cigarette rather than at the tip. This is because the first few puffs are usually not inhaled. Do not pierce the cigarette paper.

Colchicine Production

1) Dried and ground plant material are percolated with 80% ethanol for several hours. Be sure to do this in a well-ventilated area.

2) Filter the solution in the percolator and heat on a water bath to reduce volume to about 20%.

3) Add molten wax (about 1/2 of the volume) to the still hot solution, stir briskly and allow to cool. This removes fats and tars.

4) Filter to remove the wax and add three times its volume of cold water. Stir briskly. This will remove more tar.

5. The water solution is filtered and added to a separatory funnel with an equal amount of chloroform. Shake for several minutes.

6) Drain the lower (water) layer and discard it.

7) Heat chloroform solution on a hot water bath to remove all of the solvent. Do this in a well-ventilated area as chloroform fumes are narcotic.

8) Dissolve the residue in hot alcohol and filter.

9) Evaporate alcohol on a hot water bath. You now have colchicine.

If you wish to further purify your colchicine, dissolve it in the minimum amount of hot ethyl acetate. Upon cooling the colchicine will re-crystallize from the solvent.



SOURCE - Extracted from Poisonous Hemlock (conium maculatum).

FORM - Colorless oily liquid with a mousy odor.

MOLECULAR WEIGHT- 127.22

DOSAGE - 300 mg (8 to 10 drops).

HANDLING - Avoid skin contact or ingestion.

SYMPTOMS - Weakness, drowsiness, nausea, vomiting, labored breathing, paralysis, and asphyxia. Death is due to paralysis of the central nervous system.

DETAILS - A crude extract of hemlock was used by the ancient Greeks to execute enemies of the state. Plato's description of the death of Socrates is a very detailed account of the symptoms and their progression. Pure coniine has a burning taste similar to low-grade hot sauce and a characteristic odor which should be masked. Hard liquor or pungent spicy foods are best for this. Coniine poisoning is a relatively painless process, but takes several hours and the victim is conscious and aware to the very end.

Coniine Production

1) Coarsely chop one pound of fresh hemlock and macerate in a blender for 5 minutes with a mixture of 2 liters of chloroform and 200 ml of a 5% sodium hydroxide solution.

Assorted Nasties

- 2) Filter and discard solids.
- 3) Place the liquid in a separatory funnel, allow **the** layers to separate, and draw off the bottom layer. Discard this.
- 4) Add 200 ml of 2N hydrochloric acid solution to the chloroform layer, shake well, and evaporate on a hot water bath. Be sure to have adequate ventilation.
- 5) A pale green solution remains which is filtered through activated charcoal or cellite to remove the tar.
- 6) Add sodium hydroxide until the pH of this solution is basic (9 or more).
- 7) Add 200 ml of chloroform and shake well. Separate the layers in the separatory funnel. Repeat extraction for a total of five 200ml portions of chloroform, then discard water layer.
- 8) Combine the chloroform extracts and evaporate solution until no more chloroform can be smelled. The result is crude coniine. It may be converted to the hydrochloride form by passing dry hydrogen chloride gas through the solution but this is usually unnecessary.

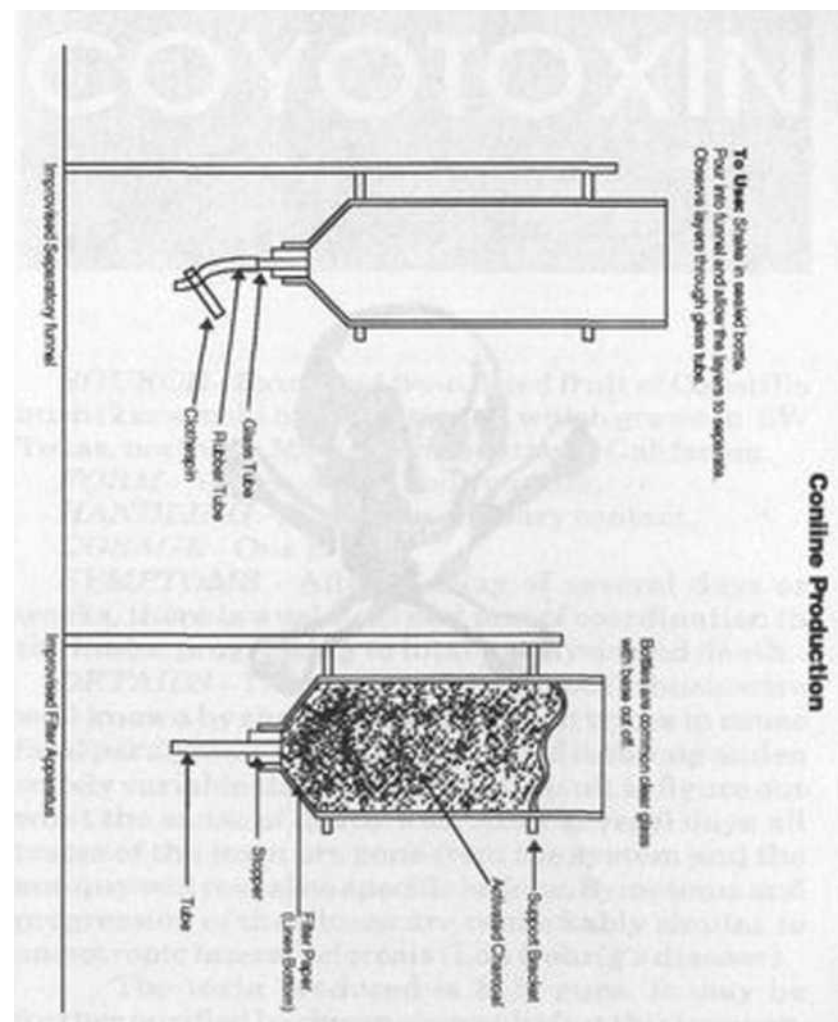

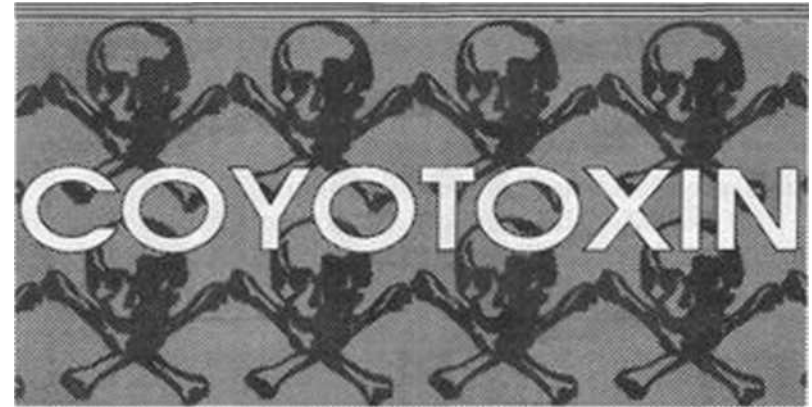

SOURCE - Extracted from dried fruit of Coyotillo bush(kar\vinski humboldtiana), which grows in SW Texas, northern Mexico, and southern California.

FORM - Yellow amorphous powder.

HANDLING - Avoid unnecessary contact.

DOSAGE - One gram.

SYMPTOMS - After a delay of several days or weeks, there is weakness and loss of coordination in the limbs, progressing to total paralysis and death.

DETAILS - The berries of the coyotillo bush were well known by the indigenous Indian tribes to cause fatal paralysis. The lag time involved is so long and so widely variable that it would be difficult to figure out what the cause of death was. After several days all traces of the toxin are gone from the system and the autopsy will reveal no specific lesions. Symptoms and progression of the illness are remarkably similar to amyotrophic lateral sclerosis (Lou Gehrig's disease).

The toxin produced is 85% pure. It may be further purified by chromatography but this is generally unnecessary for field use.

Coyotoxin Production

1) Grind the dried berries in a blender until finely powdered.

2) Add chloroform to the powder on a one for one basis, by weight, and blend for one hour at high speed.

3) Filter powder and repeat step 2 twice more at high speed, using fresh chloroform.

4) Combine the chloroform extracts and heat on a water bath until concentrated to about 20% of their original volume. Be sure to do this in a well-ventilated area, as chloroform fumes are narcotic.

5) Add this concentrate to a blender containing about 12 times as much hexane. Blend at medium speed for 5 minutes.

6) The toxin will precipitate as a dull yellow powder. Filter the precipitate and re-dissolve in the smallest amount of chloroform. Repeat steps 5 & 6.

7) Filter and dry powder.

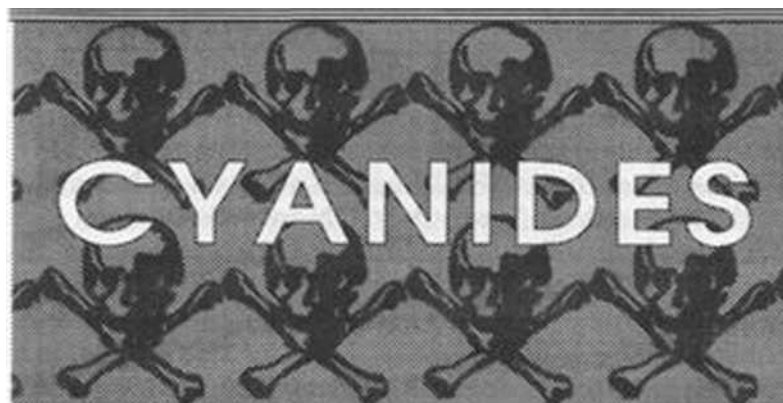

Potassium cyanide (KCN). Sodium cyanide (NaCN). Hydrogen cyanide (HCN).

SOURCE - Chemical or industrial supply. Home synthesis. Cyanides are widely used in the plastics industry for the production of materials such as nylon.

FORM - KCN - white lumps or crystals; NaCN - white powder; HCN - volatile colorless liquid with odor of bitter almonds.

HANDLING - Avoid ingestion or contact with skin. Do not inhale vapors, especially from HCN.

DOSAGE - KCN or NaCN - 300mg. HCN - 150mg.

Symptoms • Nausea, salivation, headache, rapid and deep respiration, collapse, convulsions, and death. Speed is dependent on dosage - large doses work quickly. When ingested the onset is dependent on the contents of the stomach. If it is basically empty, the symptoms will occur faster.

DETAILS - Long a staple item of assassins and mystery writers, cyanides are actually overrated for the most part. There are many poisons which are much more toxic than they are - aconitine, nicotine, and colchicine being just a few. Cyanide has one strong advantage over the others, however - when used in a moderately large dose (as listed above) they

have an awesome knockdown speed. One good breath of HCN causes almost instant unconsciousness, and death in 90 seconds. The fastest death on record for HCN is 10 seconds. KCN and NaCN usually cause death in less than 5 minutes. CN interferes with the enzyme which allows the cells to absorb oxygen, in effect causing suffocation on a cellular level. It also paralyzes the respiratory centers of the brain and constricts the blood vessels. During the 1950s the KGB employed at least 3 types of projectors that delivered an HCN mist. The weapon simulated a heart attack, but was not 100% undetectable. Few weapons are. Bogdan Stashinsky, a KGB assassin who used the HCN projector in 2 murders, described its effects as follows : "The effect of the poisonous vapors is such that the arteries which feed blood to the brain become paralyzed almost immediately. Absence of blood in the brain precipitates a normal paralysis of the brain or a heart attack, as a result of which the victim dies. The victim is clinically dead within 90 seconds after inhaling the poisonous vapors. After about 5 minutes the effect of the poison wears off entirely, permitting the arteries to return to their normal condition, leaving no trace of the killing agent which precipitated the paralysis or heart attack".

Both Goering and Himmler committed suicide by biting down on a fragile glass vial, 9 mm in diameter and 35 mm long, containing 1 cc of HCN. The vials were produced at Sachsenhausen concentration camp under SS auspices, and were housed in a small brass capsule made from 2 cartridge cases. Ironically, the HCN used was synthesized by one of the inmates, a Jewish doctor named Kramer. I can think of few jobs which would give as much satisfaction.

Cyanides are fairly easy to produce at home but have a tendency to deteriorate if not properly stored in airtight containers.

Sodium Cyanide Production

This process works equally well for the production of potassium cyanide by simply substituting potassium carbonate for the sodium carbonate. The cyanide itself is made in two steps. 1) converting the carbonate to ferrocyanide, and 2) converting the ferrocyanide to cyanide. Always wear gloves and goggles.

Step One - Sodium ferrocyanide. Three materials are used:

Sodium carbonate • common washing soda, available at any supermarket. Grind to powder in blender.

Charcoal - Get briquettes from the supermarket. Place several in a bag made of coarse cloth and place over several layers of newspaper on a bench top or concrete floor. Beat the hell out of the bag with a hammer. Charcoal powder will filter through the cloth and deposit on the newspaper.

Ferric (iron) oxide • This is plain old rust. Take a trip to the dump or junkyard with a file and paper cup. Scrape the rust off of any old iron or steel object.

Production

1) Heat a crucible to full red heat by placing it on a stand and mounting a propane torch underneath. A number of items may be used as crucibles, such as a short length of steel pipe with cap, an old oil filter housing, or a small cast iron skillet. The latter is my personal choice.

2) Pour 10 parts (by weight) carbonate, 10 parts charcoal, and 5 parts rust into a jar and shake well to mix.

3) Pour the mix into the crucible. It will soon begin to redden and fuse, generating small jets of purple flame. Stir with a fork or similar implement until the flaming ceases.

4) Turn off the heat and let the crucible cool. Pour the contents into about ten times as much hot water and stir briskly. Filter through a coffee filter and discard the solids, which are mostly unabsorbed iron.

5) Boil the liquid in a pan on the stove until most of the water is gone. Transfer it to an iron skillet and heat until all of the water has evaporated. Stir with a metal spatula while this occurs to obtain a good grade of powdered ferrocyanide.

Step Two - Cyanide Production

1) Heat the crucible to full red heat.

2) Pour 8 parts ferrocyanide and 3 parts carbonate into a jar and shake to mix.

3) Pour the powders into the crucible. The contents will melt and bubble. After a short time it will separate into two portions - solid and liquid. When bubbling ceases, pour the liquid portion onto a smooth, hard surface such as a marble countertop. The cyanide will solidify and should be broken up while still warm and stored in an airtight container.

Note - It is a good idea to have a supply of cyanide antidote ready in case you are affected by the fumes. These are sodium thiosulfate, a common photographic chemical, and amyl nitrite, a heart drug. Butyl nitrite is available in some "sex" shops as a room odorant, and may be substituted for the amyl nitrite. A few hours before beginning production of the actual cyanide, take a capsule containing 500 mg of sodium thiosulfate. It is comparatively non-toxic, but may cause a small bout of "egg burps".

This is due to hydrogen sulfide gas being generated in the stomach. It is a bit unpleasant, but not dangerous. If you feel yourself developing the symptoms of cyanide poisoning, break an ampoule of amyl nitrite and inhale its contents. Seek medical attention. The foregoing does not mean that with the antidotes you can inhale fumes with impunity, only that you prob-

ably will not die from it. Even a sub-lethal dose of cyanide is extremely unpleasant. The best way to avoid this is to always make cyanide in a well-ventilated area.

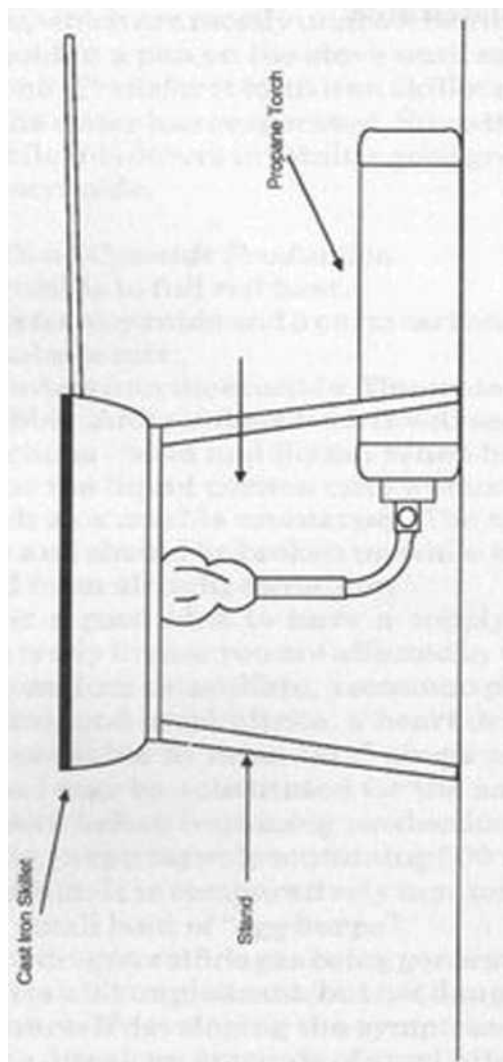

Hydrogen Cyanide (HCN) Production

HCN is the most toxic of the various cyanide compounds. Unfortunately, it also has its own special problems. The most apparent of these is that it is extremely volatile due to its low boiling point (79 * F). An open container in a warm room will evaporate in a short period of time, filling the area with deadly fumes. Its other problem is that it has a tendency to deteriorate during storage. This can be prevented by adding phosphoric acid, in a proportion of 0.5 cc per liter of HCN. This acts as a stabilizer. It also helps to keep it stored in dark glass bottles in a cool place. You may wish to wear a gas mask, as an added precaution when making HCN, but be warned, one exposure to HCN will inactivate the filter. The next time you need it, it won't work. That is why the Soviets are believed to still have HCN shells in their inventory, even though it is not very effective outside of enclosed areas.

Production (Consult illustration)

- 1) Place 6 ounces of sodium cyanide into the gallon jug.
- 2) Prepare 80 fluid ounces of an acid/water mix in a separate container by carefully pouring 25 fluid ounces of concentrated sulfuric acid into 55 fluid ounces of distilled water. Add the acid slowly to avoid spattering and allow the mixture to cool.
- 3) Begin pouring the acid mix into the dropping funnel at a slow steady rate. When the addition is complete, plug the funnel.

The HCN vapors will pass into the condenser where they will become liquid. This liquid will drip into the cooled receptacle and solidify. HCN has a high freezing point (14° C). When all of the HCN has been generated, remove the flask from the ice bath, seal tightly, and allow to warm until it again becomes liquid. Add the phosphoric acid stabilizer and reseal.

Assorted Nasties

NOTTS • Use cool, but not very cold water in the condenser. Due to the high freezing point of HCN the use of cold water may cause it to crystallize in the condenser. This process is an improvement over the old method using ferrocyanide in that it results in a product of greater purity. Commercial HCN is currently produced by reacting ammonia and methane gases in an arc furnace. While extremely cheap and effective, it is not very suitable for small scale production.

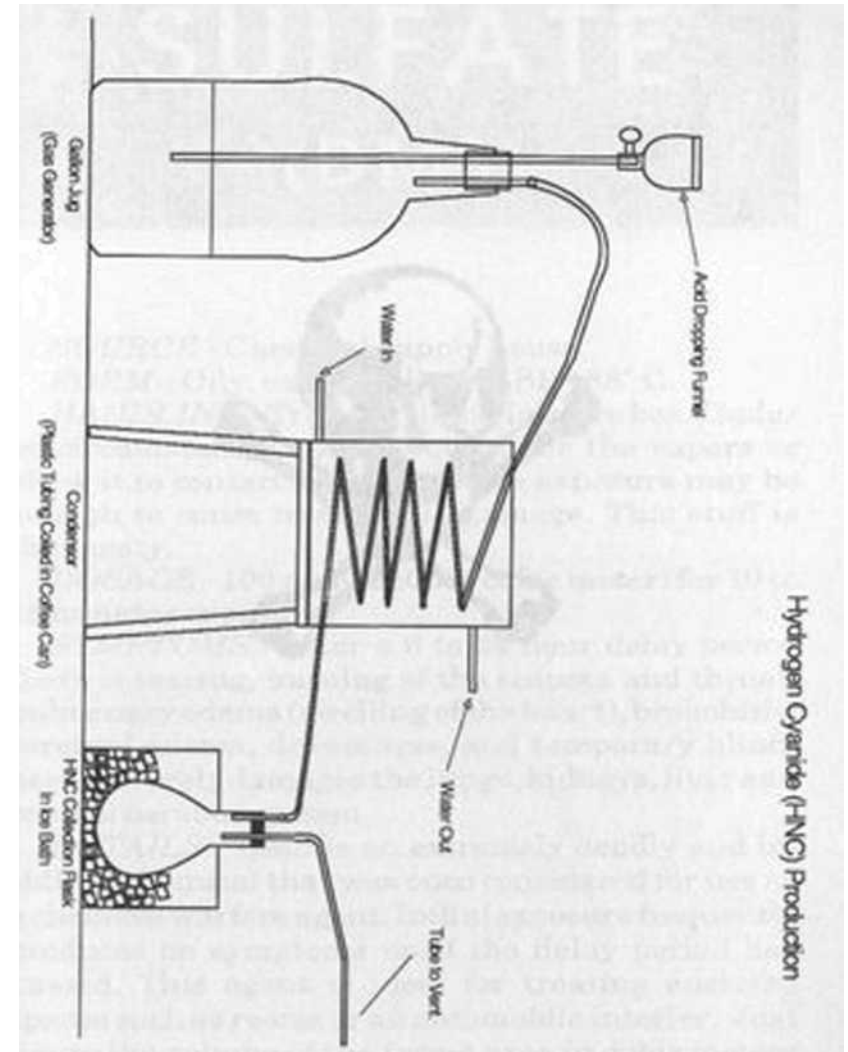

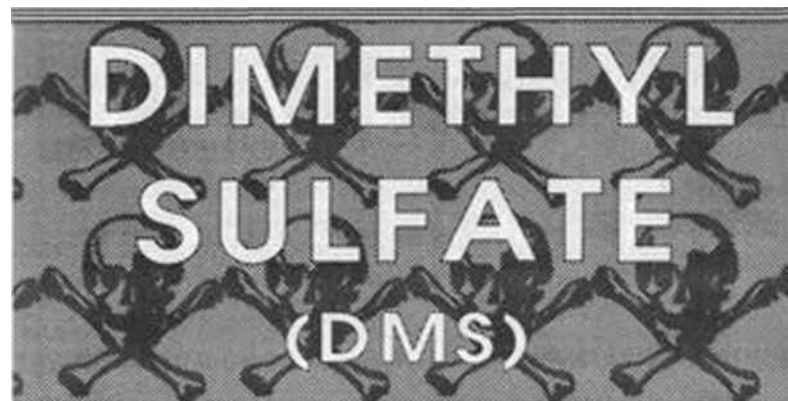

SOURCE - Chemical supply house.

FORM - Oily, colorless liquid, BP 188C.°

HANDLING - Transfer liquid in glove box. Under no circumstances should you inhale the vapors or allow it to contact your skin. One exposure may be enough to cause irreparable damage. This stuff is that nasty.

DOSAGE - 100 ppm (550mg/cubic meter) for 10 to 15 minutes exposure.

SYMPTOMS - After a 6 to 24 hour delay period there is tearing, burning of the sinuses and throat, pulmonary edema (swelling of the heart), bronchitis, cerebral edema, drowsiness, and temporary blindness. Severely damages the lungs, kidneys, liver and central nervous system.

DETAILS • DMS is an extremely deadly and insidious chemical that was once considered for use as a chemical warfare agent. Initial exposure frequently produces no symptoms until the delay period has passed. This agent is ideal for treating enclosed spaces such as rooms or an automobile interior. Just figure the volume of the target area in cubic meters and double this amount to be sure. For example, a standard sized automobile has an interior volume of about five cubic meters. Therefore, five grams would

be used. The best spot would be in or near the heating *system*, as the heat would aid evaporation. If not, simply pour it under the front seat. Winter would be the best time to use DMS, as the windows are normally closed, allowing maximum vapor concentration. This also holds true for most other CW agents when used in enclosed areas.

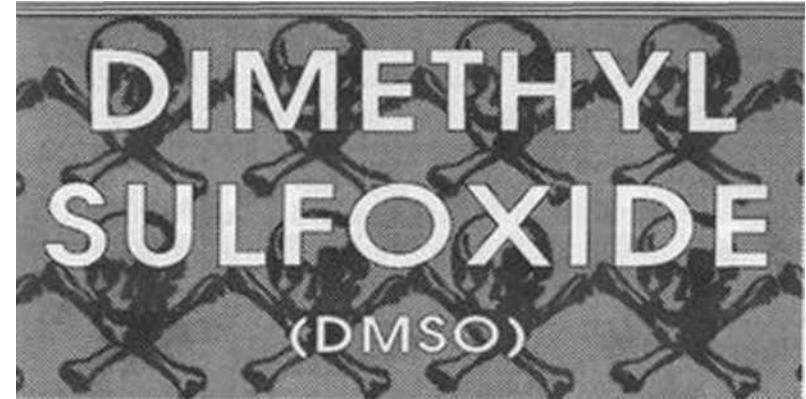

SOURCE - Chemical supply, veterinarian supply, some health food stores.

FORM - Clear liquid with consistency of light vegetable oil. Slight odor and taste of garlic or sour milk (Perception varies with individuals).

HANDLING - No special handling is needed when in pure form. Protect from freezing and contamination.

DOSAGE- Variable (See details).

SYMPTOMS - Variable (See details).

DETAILS - DMSO is a common solvent derived from wood pulp. It is unique among the items in this book in that it is essentially non-toxic by itself. Its value lies in the fact that it is an exceptionally fine intradermal penetration and carrier agent; it soaks through the intact skin in minutes, taking whatever it is mixed with into the bloodstream and leaving no external marks. The rate of absorption varies with the toxin it is mixed with and the condition of the skin. For example, the hands of one accustomed to hard physical labor would be more resistant than those of one who pushes paper at a desk all day. By itself it is an analgesic and anti-inflammatory drug, working particularly well for arthritis and muscle sprains. Mixed with other drugs or chemicals it can enhance or

reduce their effect, depending on the drug. Organophosphorus compounds such as insecticides and nerve gases, for example, exhibit a six-fold increase in toxicity when mixed with DMSO.

Ricin mixed with DMSO would be an outstanding weapon, both subtle and deadly. The problem is that ricin doesn't dissolve properly in DMSO. Some success has been achieved with ricin dissolved in a slightly acid solution (pH4) and then mixed with DMSO, but further experimentation is needed. For some reason that is not yet clearly understood, 90% DMSO and 10% water works better as a carrier agent than 100% DMSO. In fact, concentrations as low as 70% will work almost as well as 90%.

To Use DMSO As a Contact Poison

Place a measured dose of the toxin in a test tube and slowly add DMSO drop by drop, with stirring, until all of the toxin is dissolved. This unit is your full dose. Whenever possible, use twice as much toxin as necessary.

This solution may be painted on an area the subject will touch, such as a doorknob or chair seat. In a crowd situation, it could be squirted on the back of his shirt or trousers. Any attempt to wipe it off will only serve to increase its rate of absorption. Any accidental spills should be quickly blotted off, using blotting paper or absorbent tissues. Do not rub the area.

Contact poisons work best when they contact relatively soft, uncalloused skin. Taken orally, it increases the speed of absorption through the stomach lining.

Extreme caution is necessary when using contact poisons. They do not distinguish the difference between your skin or the target's. The result is the same.



ANALOGS - 3-Methyl Fentaoyl. many others

SOURCE - RX, chemical synthesis. Controlled substance.

FORM- White crystalline powder. (MW-336.46)

HANDLING - Avoid inhalation or ingest ion. Extremely low toxic dose.

DOSE - One milligram.

SYMPTOMS - Unconsciousness and rapid death.

DETAILS - Fentanyl is an intravenous anesthetic agent used in surgery. It produces the same effects as opiates but at a much lower dosage. This is typically no more than 200 micrograms maximum. It is so fast acting that there are cases of addicts who didn't have time to remove the needle from their arms before dying. [In one case, the victim was discovered by the police standing next to his truck, leaning in the door. He had been dead for several hours. One milligram is more than enough to cause rapid death when given intravenously. Some of Fentanyl's analogs (drugs of similar chemical structure and effect) are even more powerful than this. Definitely a "Dangerous Drug". It is marketed under the trade name "Sublimaze" in ampoules of 50 micrograms per milliliter concentration.

Fentanyl and its analogs are produced in clandestine laboratories and sold on the street as synthetic

heroin. It may be possible to obtain it from this source, but at a high price - it sells for about 5,000 dollars a gram. If you find such a chemist, he may prove useful in producing other needed compounds, if approached correctly. When making or using fentanyl it is important to keep in mind that these are controlled substances. Most normal toxic substances are not illegal to make or possess. Your story that you only need it to kill someone and are not an illicit drug manufacturer will not impress the authorities. Also note that a dose the size of one or two grains of salt is enough to OD on, so extreme caution in handling is needed.

Fentanyl Production

- 1) Prepare 2 solutions as follows - (A) Dissolve 5 parts N-(4-piperidyl) propionanilide, 6.85 parts sodium carbonate, 0.05 parts potassium iodide in 120 parts hexane. (B) Dissolve 3.8 parts B-phenylethylchloride in 24 parts 4-methyl-2-pentanone.
- 2) Place solution A in a 3 necked flask equipped with a dropper, a mechanical stirrer, and a reflux head. Turn on the stirrer and add solution B slowly dropwise until all is added. Plug the dropper neck, turn on the heating mantle, and reflux for 27 hours, with constant stirring.
- 3) Filter the mixture while hot and evaporate the liquid on a steam bath.
- 4) An oily residue remains which is dissolved in 160 parts diisopropyl ether and filtered several times until clear.
- 5) Concentrate this solution to a volume of about 70 parts.
- 6) Cool liquid for about two hours at a temperature of about 0°C to yield the fentanyl.

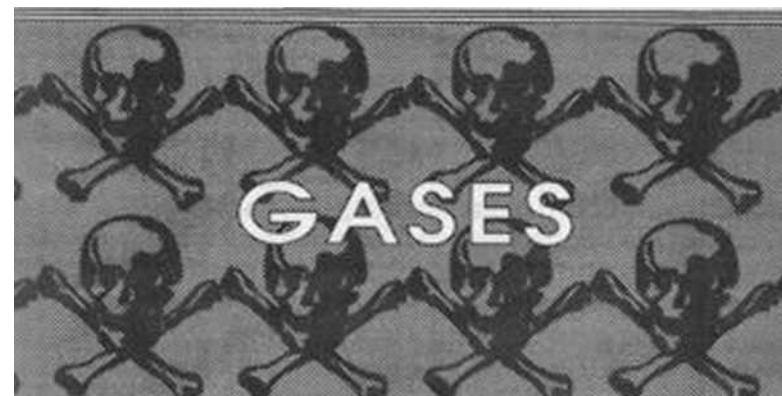

Home-Brew Nerve Gas, HNG

SOURCE - Combination of commercially available materials.

FORM - Liquid, variable color and consistency (See details).

HANDLING - Avoid all contact with the skin or inhalation of vapor.

DOSAGE - Variable (See chart).

SYMPTOMS - Pinpoint pupils, dim vision, runny nose, tightness in chest, nausea, convulsions, coma, and respiratory failure.

DETAILS - Conventional nerve gases such as Sarin or VX are particularly valuable because of their high toxicity and fast action. However, their desirability is decreased by the comparative difficulty of production. HNG is an acceptable substitute in most cases. It is not, strictly speaking, a gas, but rather an aerosol and topical poison similar to VX in those respects. It is simple to make, requiring only that you mix the active ingredient (certain insecticides), with DMSO in equal amounts. Most of the products listed are commercially available anticholinesterase agents, very similar to nerve gases in structure and function. The pure forms of these agents are used in the formulation of various insecticides. Therefore this is

the best place to acquire them. Dilute solutions are available at retail level, but are less desirable due to the increased dosages required. Use the same caution in handling that you would with any contact poison. Do not be deceived into thinking that because they are so easy to make that you can be sloppy or careless with them. Nothing is further from the truth. They are very close to conventional nerve gases in toxicity. In fact I would recommend that they not be made up until needed. That helps alleviate the storage problem.

Home-brew Nerve Gas
Toxicity / Dosage Chart

All listings are for toxins already mixed with DMSO on a 50/50 ratio. Dosages are expressed in milligrams of solution per kilogram of body weight (mg/kg) for topical application. All listings are trade names.

| Toxin | mg/kg |
|--------------------|---------|
| Fensulphothion | 0.8 |
| Mipafox.Isopestox | 1.2 |
| Dimefox | 0.4-0.8 |
| Phorate.Thimet | 0.5 |
| TEPP | 0.4 |
| Systox, Demeton | 1.0 |
| Terbuphos, Counter | 1.2 |

Note - TEPP decomposes in about 6 hours in a moist environment. The rest will remain stable for about one week to one month, depending on the weather conditions.

Toxin - Mustard Gas. Dichloroethyl Sulflde, H.
SOURCE - Chemical synthesis.

FORM - Transparent amber oily liquid. Odor resembles horseradish or mustard (hence the name). Solidifies at 14C. (MW-159.08).

HANDLING - Avoid all contact with liquid or its vapors. A good military gas mask and decontamination suit are required. If kept cold it is reasonably safe to transport but if warm the vapors can penetrate the rubber seals on the containers. This property makes it very difficult to store safely.

DOSAGE - 0.15 mg per liter is fatal on 10 minutes exposure and 0.07 mg per liter on 30 minutes exposure. Concentrations as low as 0.001mg per liter on 1 hours exposure will attack the eyes.

SYMPTOMS - After 4 to 6 hours, inflammation of the eyes, blistered or ulcerated skin, inflamed nose, throat and lungs. Temporary blindness which may last for weeks. Blisters are very slow healing.

DETAILS - Mustard gas (H) is one of the older chemical warfare agents. Known as the "King of War Gases", it was responsible for 25% of the total casualties in WWI. While not excessively deadly (average 2% mortality rate) unless in strong concentration or long exposure, it is unsurpassed for area denial and will cause large numbers of casualties. Symptoms occur in low concentrations and it can remain active for several weeks in the open. It is classified as a -persistent" agent.

H is reasonably safe to handle if kept cold, but anything coming into contact with the liquid or its vapors should be washed thoroughly with a bleach solution. H may be prepared in two ways - by adding hydrochloric acid to thiodiglycol or by bubbling ethylene gas through liquid sulfur dichloride (Levinstein process). The latter is the route we will take. While a simple process, the manufacture of H is extremely hazardous due both to the nature of the sulfur

dichloride used and the completed product. H made by the Levinstein process contains about 30% impurities, but these have proved to be of no consequence in its field use. It will generate gases on storage which can build pressures and cause explosions if not vented properly. These should be bubbled through a bleach solution to decontaminate them. H can be destroyed by adding the liquid to about five times its volume of bleach solution. After 30 minutes it may be safely disposed of.

Both ethylene and sulfur dichloride are commercially available. If they can be obtained from this source you can eliminate steps A and B and combine them as covered in step C.

Preparation of Mustard Gas (H)

Step A - Preparation of sulfur dichloride.

1) Place 100 grams of powdered sulfur in a 500 ml boiling flask.

2) Heat the flask in an oil bath until the sulfur melts (approx. 215°C).

3) Place a 2 hole stopper which has been fitted with a length of stainless steel tube in one hole and a length of plastic tube in the other. The stainless steel tube must extend to near the bottom of the sulfur.

4) The plastic tube is attached to a 500ml flask which is cooled in an ice/salt cooling bath. A second plastic tube is run from this to a water trap.

5) A gas generation bottle is set up containing 100 grams of calcium hypochlorite. Begin addition of a mixture of half muriatic acid and half water in a slow dribble. A total of 200 grams of this acid mix will be needed. The yellowish-green chlorine gas should begin generating. If not, then a gentle application of heat should get things going.

6) As the sulfur absorbs the chlorine it will begin to liquefy into sulfur dichloride. This will vaporize and collect in the cooled flask.

7) When all of the liquid has come over into the collection flask it should be cooled and filtered through 2 coffee filters.

NOTE - Sulfur dichloride is a hazardous chemical which is very corrosive and irritating to the eyes, nose and throat. Handle accordingly.

Step B - Preparation of Ethylene

1) Place a mixture of 4 parts concentrated sulfuric acid and one part denatured ethanol in a flask containing enough clean, dry sand to form a thin paste.

2) Heat the flask to about 170°C in an oil bath. The gas which is generated is bubbled through a water washer, then through a weak lye washer. This will purify the gas.

Step C - Preparation of Mustard Gas

A tube is run from the last washer bottle in Step B, attached to an aerator, and placed in the flask of sulfur dichloride which is cooling in an ice/salt bath. The gas is bubbled through until the generator no longer produces. The specific gravity is then checked by placing the flask in a glove box. Draw off about 10ml into a test tube and check with a hydrometer. It should be at least 1.27. If so, pour the sample back into the flask and decant into storage bottles. Seal tightly and wax dip the tops. If the specific gravity is not correct, repeat the gas generation step until it is. Place test tube and hydrometer into a beaker of bleach solution to decontaminate them.

Purifying Mustard Gas

If, for some reason, you need a highly pure sample of II, possibly for some special device, here is the lab purification process. Be sure to carry it out at low temperature. In the process you will lose at least half of your H. so it's not really practical for large scale use, especially considering the solvents and equipment needed.

Assorted Nasties

1) Set up a distillation rig for fractional distillation at high temperature. The flask is placed in an oil bath containing a high temperature silicone oil.

2) Filter your sample of H and fill the flask about half full.

3) Distill and collect the fraction that comes over at 215° - 217°C . The collection flask must be cooled in an ice bath.

This is a very good grade of H and entirely suitable for most purposes. If you need it even purer, proceed to step 4.

4) A 13 gram sample is dissolved in 200cc of absolute ethanol, which has been cooling in an ice bath. The flask is then tightly stoppered and further cooled in a dry ice/acetone bath (-75° to -80°C) for 30 minutes.

5) Carefully pour off the liquid from the crystals and repeat step 4 twice more with additional new alcohol.

6) Carefully pour off the liquid from the crystals and dissolve in 200cc of precooled petroleum ether. The H will re-crystallize into large crystals.

7) Pour off the liquid and evaporate the remaining solvent from the crystals under vacuum at 5°C . Yield is approximately 7-8 grams.

Remember - It is very important to keep the H and solvents at 5°C or lower. This is the only safe way to handle H.

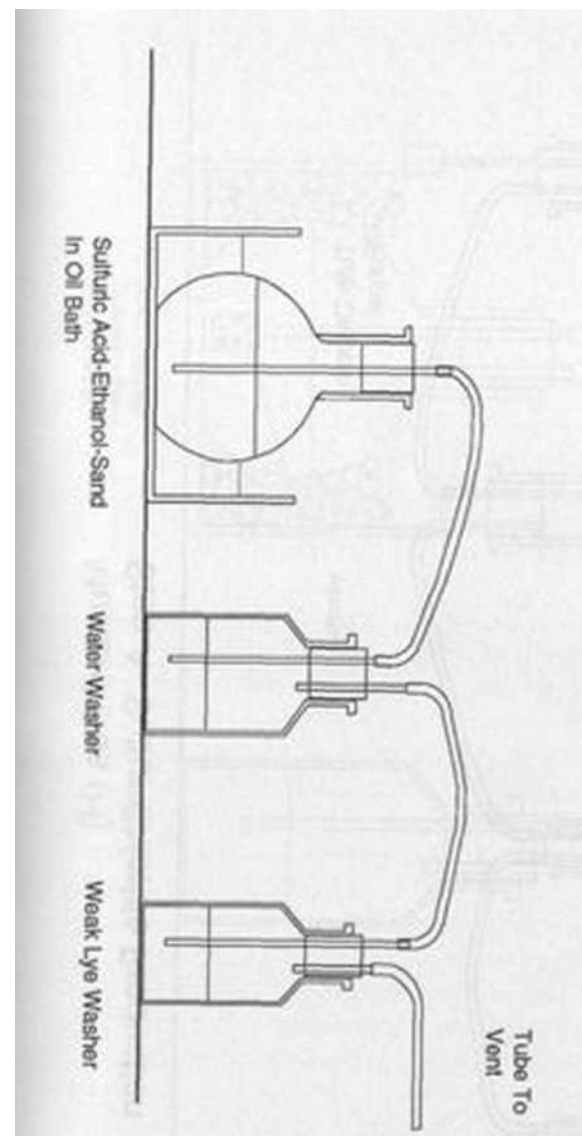

Mustard Gas (H)
Step B- Sulfur Ethylene Production

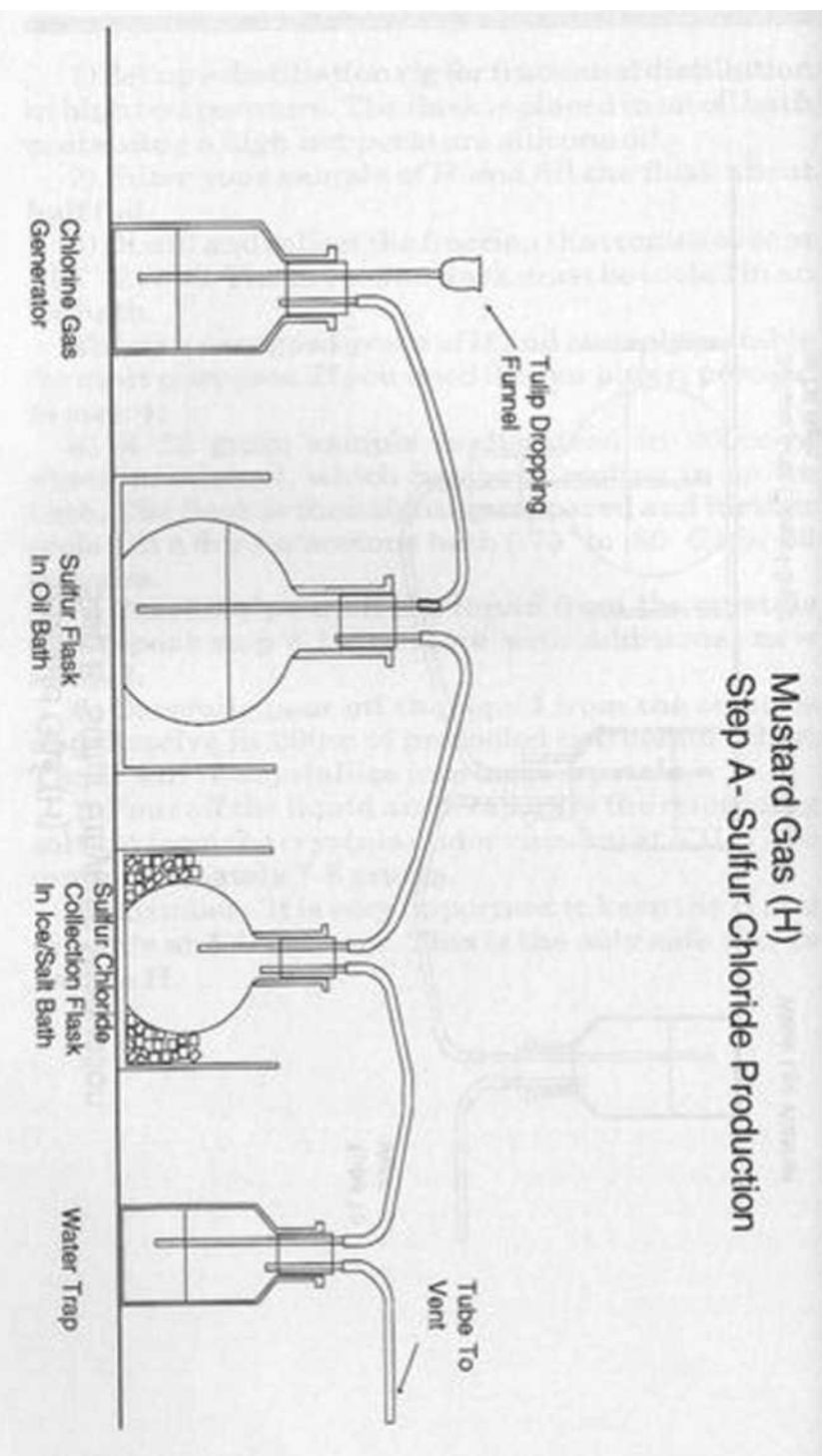
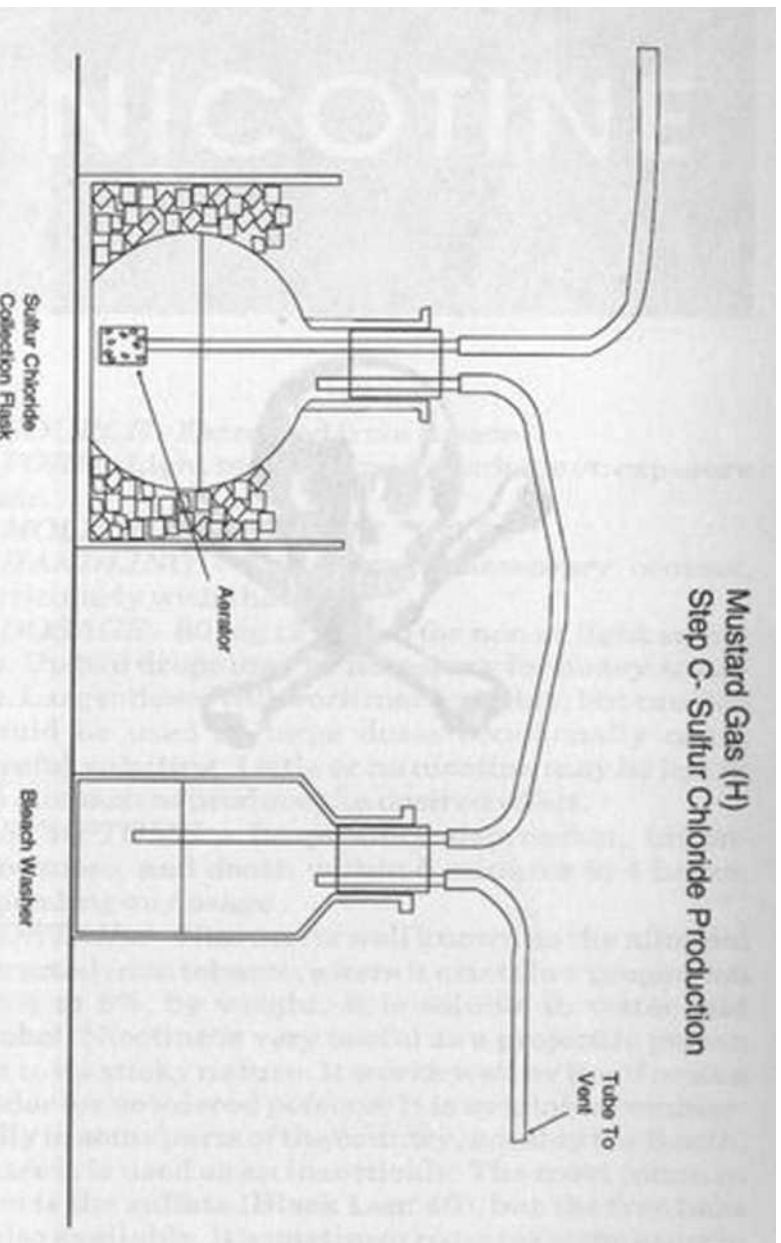



SOURCE - Extracted from tobacco.

FORM- Light tan oily liquid. Darkens on exposure to air.

MOLECULAR WEIGHT- 162.23

HANDLING - Avoid any unnecessary contact, particularly with the skin.

DOSAGE - 80 mg (2 drops) for non or light smokers. Up to 6 drops may be necessary for heavy smokers. Larger doses will work more quickly, but caution should be used as large doses occasionally cause forceful vomiting. Little or no nicotine may be left in the stomach to produce the desired effect.

SYMPTOMS - Respiratory depression, unconsciousness, and death within 5 minutes to 4 hours, depending on dosage.

DETAILS - Nicotine is well known as the alkaloid extracted from tobacco, where it exists in a proportion of 2% to 8%, by weight. It is soluble in water and alcohol. Nicotine is very useful as a projectile poison due to its sticky nature. It works well by itself or as a binder for powdered poisons. It is available commercially in some parts of the country, notably the South, where it is used as an insecticide. The most common form is the sulfate (Black Leaf 40), but the free base is also available. It sometimes requires some search-

ing to find the lab grade (98%) but is worth it. Some chemical retailers are accommodating enough to order it for you, as it is usually not a stock item. I got 250ml this way. You would be surprised at what is available on the open market, if you approach the retailer in the right way (that is, don't look like anything other than a normal person and do a little background research on the chemical you wish to purchase, so as to be able to intelligently discuss it if needed). The prices may make you choke, but there is a chemical company which supplies everything from saxitoxin to botulin, for a high price.

Nicotine Production

1) Preheat an oven to 250°F for ten minutes. Turn off. Place the tobacco on a cookie sheet and dry for about 10 minutes. Leave the oven door cracked and make sure you don't scorch it.

2) When dry grind the tobacco into a fine powder. Place this in a jar and cover it with twice as much lime water, by volume.

3) Heat almost to a boil for 5 minutes, remove from heat and let sit overnight. Shake occasionally.

4) Reheat to boiling and filter to remove tobacco particles.

5) Fill a still 1/3 to 1/2 full of the liquid, add a few boiling stones, and distill until the liquid is almost gone. A brownish-black residue will remain which is mostly tars.

6) Cool the distillate to room temperature. Add to a separatory funnel with an equal volume of ethyl ether and shake for several minutes.

7) Allow the layers to separate. Draw off the bottom (water) layer and discard.

8) Place the upper (ether) layer in flask with a vent hose running to the outside. Place the flask in a pan filled with hot water (Do not directly heat the pan or flask! Ether is highly explosive). Boil off the ether. Add more hot water to the pan if needed.

9) What remains is a *very* good grade of nicotine. Store in a well sealed bottle.

Note - AH mentioned before, ether fumes are explosive. Never work with it around an open flame or heating element. Never allow its fumes to build up in the work area. Even the spark from a light switch can ignite the fumes. Also use care when venting the fumes as this is one of the chief ways that the authorities uncover illicit drug laboratories.



SOURCE - Seeds of Castor bean bush (*ricinus communis*).

FORM - White amorphous powder.

MOLECULAR WEIGHT - 65,000.

HANDLING - Always wear dust mask and gloves.

DOSAGE - Type #1-10 mg orally. Type #2-2 mg orally. Inhalation dosage is about 10 times less than oral. Injection dosage is approximately the same as inhalation.

SYMPTOMS - Oral - After a delay of several days there is vomiting and high fever. Death can occur up to 14 days after onset of symptoms. Injected or inhaled - same as oral, but they begin within several hours and death occurs in a few days.

DETAILS • Ricin is a toxic protein extracted from the castor bean seed. This bush is a common sight in the southwest United States where it can be found growing wild or cultivated as an ornamental shrub. The seeds are contained in a small spiny green seed pod about 5/8 inch in diameter. This pod is split open to reveal three small hard seeds.

Ricin is the deadliest plant toxin known. It also has the advantage of being impossible to detect at an autopsy. (Note - Work is currently being done at the University of Leeds in England to develop a means of

detecting ricin and other toxic proteins. This test is quite complex and will probably only be used when there is a strong suspicion that one of these toxins has been used). Bulgarian dissident Georgi Markov was assassinated in London in 1978 with an umbrella gun firing a ricin filled pellet. Within a few hours he developed a high fever and vomiting. In three days he was dead. It was thought at the time that he had died of blood poisoning, but during the autopsy a tiny platinum pellet was found imbedded in his upper thigh. Microscopic examination revealed two holes in the pellet drilled at 90° angles to each other. No trace of the toxin was found during examination at Porton Down chemical warfare center, but it was discovered that by injecting pigs with a ricin solution identical symptoms were produced. (Pigs have a physiology remarkably similar to a human's in many respects. The dose that would kill a pig would correspond to that which would kill a human of the weight).

Ricin is insoluble in normal water solutions, but combines well with slightly acidic water or lemon juice. It may be dissolved in water at a pH of 3.8 to 4.0 for injection or finely powdered for ingestion or inhalation. Its only drawback is that it is heat labile—meaning it will be inactivated by heating to over 100° C when in solid form or 60° C to 70° C in solution. The heat of grinding will also destroy the toxin, but if you gently crush it on a glass surface, using the back of a spoon or similar instrument, no deactivation should occur. Even with this limitation it is as close to a perfect poison as is available. It is odorless, tasteless, undetectable, untreatable, and fatal in minute dose. Gram for gram ricin is deadlier than most nerve gases. Anything with this much power should be handled with the utmost caution and respect.

We will examine two methods of production:

Type # 1 (Field grade) - Using acetone, table salt,

Epsom salts, and water. By far the easiest method for producing gram or smaller quantities. The only drawback is that the ricin produced is not as pure as the second method.

Type # 2 (Blender method) - Using acetone, dilute sulfuric acid, sodium hydroxide (lye), sodium carbonate (washing soda), sodium sulfate, and carbon tetrachloride. Uses more chemicals and equipment but produces an article of much greater purity. All chemicals used are cheaply and readily available. Geared to the production of larger quantities than field grade, this method was actually developed to produce ricin (for use by the Chemical Warfare Branch of the Army).

Type # 1 (Field Grade) Ricin Production

Materials needed: Approximately 1/2 cup castor bean seeds, 2 one-pint jars, one filter funnel, coffee filters, one pint acetone, table salt, water, and a pair of pliers.

1) Crack the seeds gently with the pliers and remove the hard outer shells. Deposit the seed pulps <• of the jars.

2) When all of the seeds are shelled, cover the pulps in the jar with six times as much acetone. Mash the beans with a spoon or stick until they are broken up. Let this sit overnight. Periodically, the mush in the bottom should be poked and stirred to keep lumps from forming and to remove as much of the oil as possible

3) Line the funnel with one of the coffee filters and pour the acetone/bean pulp slurry through it. When drained, spread the filter on a newspaper and dry overnight. Discard the acetone/oil solution in the jar. Feel the powder. If it clumps when dry it still has too much oil in it. If so, repeat step # 3 until a fine dry powder is produced.

4) Scrape the powder off the filter into the second jar and fill it with a lukewarm (not hot) salt solution

(10 prams of salt per 100 milliliters of solution). Let this sit overnight, shaking the jar occasionally.

5) Filter this solution and discard the solids caught on the filter.

6) Add an equal volume of saturated solution of Epsom salts, shake briskly, and let sit. After a short time a fine white powder will precipitate from the solution. This is ricin. When precipitation has ceased, as much of the liquid as possible is carefully poured off, taking care not to disturb the powder on the bottom. The remainder is then filtered and allowed to dry overnight at room temperature. When the filtrate is dry put on rubber gloves and a good dust mask. Carefully scrape the ricin off the filter and store in a well-sealed container.

Note: The optimum temperature for this process is 25° C. If the solution is cold it will be difficult, if not impossible to cause precipitation. If necessary, warm the jar in a basin of warm water. Do not allow it to become hot or the toxin will be destroyed.

Type # 2 Ricin Production (Blender Method)

1) Pour the whole beans into the blender. Add just enough acetone to cover them and grind for one minute. Check to make sure that all beans are ground up and that the temperature has not risen too much.

2) Add four times as much acetone as bean pulp to the blender and liquefy for several minutes.

3) Pour off the acetone and replace with an equal amount. Liquefy again for several minutes. Discard the used acetone.

4) Filter the slurry and allow the filtrate to dry thoroughly.

5) Add filtrate to blender with four times as much distilled water at a pH of 3.8 and a temperature of 25°

C. Liquefy for several minutes. Note: the preferred pH range is 3.5 to 4.0. 3.8 is optimal. 5% sulfuric acid is preferred for pH adjustment, although dilute hydrochloric acid can be used.

6) Filter slurry and discard filtrate.

7) Raise pH of this solution to pH 7 to 8, using 5% sodium hydroxide or 12% sodium carbonate.

8) Treat the solution with a 16.7% solution of sodium sulfate (2 pounds of salt to 10 pounds of water) to precipitate the toxin. Add a little at a time and cease additions when no more toxin is precipitated. Allow up to 5 minutes between additions..

9) Filter solution and discard the liquid. Wash filtrate with some of the sodium sulfate solution. This will remove an additional 15% non-toxic nitrogen.

10) The filtrate is dried and slurried with carbon tetrachloride to separate the ricin by flotation. Use caution handling carbon tet as it is a suspected carcinogen and has toxic fumes. The ricin is skimmed off the top. Dry and grind carefully.

11) Ricin is added to three times its weight of distilled water and brought to a pH of 3.8, using 5% sulfuric acid.

12) Filter the slurry and neutralize the pH by adding 12% sodium carbonate solution, a little at a time, until a pH of 7 to 8 is reached.

13) A second precipitation is brought about by adding the sodium sulfate solution. A precipitation time of 45 minutes is required.

14) The solution is filtered and the ricin is washed on the filter with sodium sulfate solution to remove additional non-toxic nitrogen.

15) The filtrate is dried, ground carefully, and slurried with five times its weight of carbon tetrachloride to separate the sodium sulfate by flotation. Skim the ricin off the surface. The nitrogen content is then reduced from 40 to 50%, to 15 to 18%.

Assorted Nasties

16) Dry and carefully grind into a fine powder. Store in a well-sealed container and protect from heat.

NOTE: The grinding steps are the Achilles heel of this operation. The heat generated by grinding can easily deactivate the toxin. An air grinder was developed that eliminated this problem and may be available commercially. For best results the ricin should be as fine as possible.



GB Isopropyl Methyl Phosphonofluoridate

SOURCE - Synthesis in good chemical laboratory.

FORM - Thin oily liquid, clear to amber in color, odorless. BP 158°C.

MOLECULAR WEIGHT - 140.9

HANDLING - Avoid inhalation, ingestion, or skin contact. Handle only in a glove box equipped with decontamination apparatus. A good military gas mask should be available.

DOSAGE - Very low through all routes. Inhalation dosage is 10 mg. Oral dose is about half of that. Skin absorption dose is about 1500 mg due to the volatility of the compound. If GB is mixed with an equal amount of DMSO it will absorb through the skin before it can evaporate. If pure GB comes into contact with a cutor abrasion on the skin, absorption will be rapid.

SYMPTOMS - Pinpoint pupils, dim vision, runny nose, tightness in the chest, nausea, diarrhea, coma, and respiratory failure. Death usually occurs in from 1 to 10 minutes, depending on the concentration. Non-lethal doses are usually followed by complete recovery in from 1 to 3 days. However, doses are cumulative if received over a period of a few days.

DETAILS • GB is the second of the nerve gases developed by the Germans in WWII. It is now the standard nerve agent of the United States, being stored both in bulk and loaded into various munitions. The synthesis of GB is fairly straightforward, but extremely dangerous for anyone not intimately familiar with organic chemistry procedure. Many of the chemicals used are hazardous in their own right. One explodes on contact with water, another is an anesthetic gas at normal temperatures. All chemicals and processes should be thoroughly investigated before synthesis is attempted. All safety measures must be strictly adhered to if explosion or accidental poisoning are to be avoided. Frankly, there are safer toxins of greater power available. A good mixture which approaches GB in toxicity is a 50/50 mix of the insecticide Parathion and DMSO. This is more practical for small scale applications and penetrates the skin much faster than pure GB.

Sarin Production

1) 133.3 grams of anhydrous aluminum chloride and 137.4 grams of phosphorus trichloride together in a Pyrex glass pressure bottle, seal and shake mechanically for one hour or until all of the aluminum chloride is dissolved.

2) Heat to 60* C in a hot water bath.

3) Cool the flask in a dry ice/acetone bath and add 50.5 grams of precooled methyl chloride, seal as before and place in a heavy walled steel pipe with screw caps (this is important, as explosions occasionally occur during this step). Allow to come to room temperature.

4) Place the pipe in a mechanical shaker for one minute. When it is removed and opened the reaction mixture should have solidified into a colorless cake.

5) Dissolve the cake in 700 cc of methylene dichloride and cool to -20 * C in a dry ice/acetone bath. Add ten 5 cc portions of water, shaking vigorously between additions.

6) Filter out the solids.

7) Add mixture to a separatory funnel and drain off the lower (water) layer.

8) Place the liquid in an evaporating dish on a hot water bath and drive off the solvent. Add the resulting crystals to a minimum amount of hot methylene dichloride. Let cool and the crystals will come out of the solvent producing methylphosphonodichloridate (dichlor), which has a melting point of 33 " C.

9) 60% of the dichlor is placed in a flask containing enough methylene dichloride to dissolve it. A gas (diffusion tube is installed and dry hydrogen fluoride gas is passed through for approximately one hour. In this manner the dichlor is converted in methylphosphonodifluoridate (difluor). Remove the solvent on a hot water bath.

10) Equimolar quantities of dichlor (MW 132.91) and difluor (MW 100.01) are dissolved in methylene dichloride and heated to reflux temperature in a three-necked flask equipped with a reflux head, a stir motor, and a dropper. An equimolar quantity of isopropanol (MW 60.11) is added dropwise with stirring at a rate sufficient to keep the mixture boiling gently. Reflux for one hour after the last of the isopropanol is added.

11) Remove the reflux head, hook up a vacuum Hourse with solvent trap and evaporate the solvent under reduced pressure. Warning - The product is now crude Sarin and must be handled accordingly.

12) Set up a distillation rig for fractional distillation under vacuum and distill the liquid at 11 mm of pressure. Sarin is the fraction collected at 49.5 * C. Yield is roughly 70 grams.

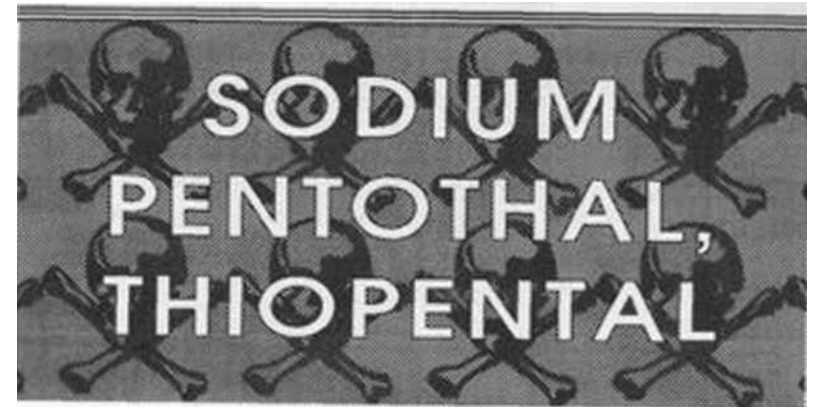

SOURCE - Medical supply. Controlled substance.

FORM - Yellowish white powder.

HANDLING - No special handling required but avoid unnecessary contact.

DOSAGE - One gram, intravenously.

SYMPTOMS • Unconsciousness within one minute. Death occurs shortly thereafter.

DETAILS - Sodium pentothal is one of the most widely used anesthetics in medical and dental practice. It is also the drug of choice for suicidal doctors, so its lethal potential is well proven. It is an ultra-short acting depressant of the central nervous system. It induces hypnosis and anesthesia, but not analgesia (pain relief) Hypnosis is produced within 30 to 40 seconds of injection.

To use - The powder is weighed and placed in a test tube. Distilled water is added drop by drop, with stirring, until all of the powder is in solution and the liquid is clear. If the water is slightly alkaline the mix will keep better, but the solution should be freshly prepared for best results. Pentothal also has the distinction of being the fastest acting poison known. An injection directly into the heart causes death within 2 seconds. This requires a # 20, 3 1/2 inch cardiac needle to be inserted into the intracostal

space between the ribs, directly into the heart. The syringe plunger is withdrawn slightly to check for the blood which will verify that the needle is in the heart. The syringe is then emptied in a smooth rapid stroke. Pentothal is a very specialized substance for use when it is desired that the death be as painless as possible.

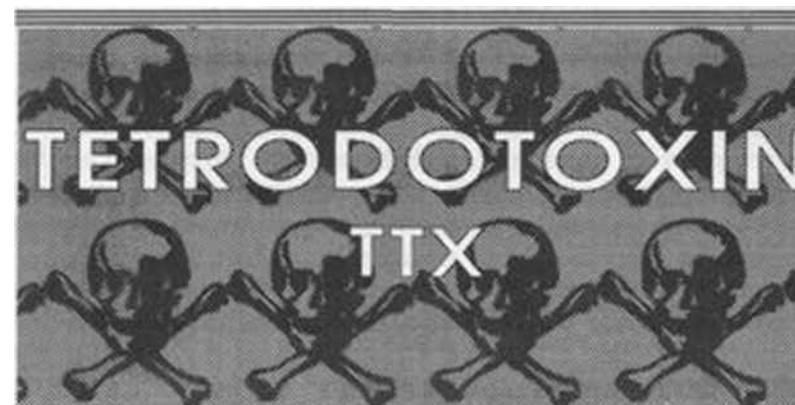

SOURCES - Extracted from viscera of various species of marine life. Synthesis is possible, but the process is extremely long and difficult.

MOLECULAR WEIGHT 319.28

FORM - Pure - colorless crystals. Crude - yellowish powder.

HANDLING - Avoid unnecessary contact.

SYMPTOMS - Tingling of the tongue and lips that gradually spreads to the entire body, weakness, collapse, paralysis, and death due to respiratory paralysis and collapse of the central nervous system.

DETAILS - TTX is the potent toxin extracted from the liver, intestines, and gonads of the puffer fish, members of the tetraodontidae order. It has also been isolated from the California newt (*Taricha torosa*), certain frogs of the *Atelopus* order in Central America, the Taiwanese Goby fish, and the Australian Blue-ringed octopus. At least 15 species of puffer have been found to be toxic, most of them from the genus *Spherooides*. The puffer has a worldwide equatorial distribution and is mentioned in many ancient texts, ranging from the Egyptian medical books, Chinese herbals, and the Bible itself. The Japanese have used a crude extract of TTX for many years as an analgesic and in various folk remedies. As late as 1967 you could

buy this extract in Tokyo for less than six dollars a gram. The flesh of the puffer, called "Fugu" in Japan, is regarded as a great delicacy. It is prepared by specially trained chefs who must pass a rigorous examination before receiving their license. At least 50 people a year die from eating fugu that they prepare themselves. In the western hemisphere, some of the best sources of TTX are the "botete" fish (*Spheoroides lobatus*), found off Baja California, and several species of puffer found in the Caribbean (*S. testudineus*, *S. spengleri*). Puffers are most toxic during peak, mating season, usually around June. TTX is both fast-acting and powerful, but has one flaw - it takes a lot of raw material to get a usable amount of pure toxins. Researchers under contract for the U. S. Army processed 100 pounds of livers and ovaries from the Japanese puffer (*Spheoroides rubripes*) to get 100 milligrams of pure TTX. This corresponds to about 2,000 pounds of raw fish. The book "Poisonous and Venomous Marine Animals of the World", by Dr. Bruce W. Halstead, is the most complete reference on the fishes, their breeding cycles, their habitat, and their toxins. It also contains the extraction process developed for the Army should you have a surplus of puffer fish and want the absolutely pure toxin. We will opt for an older method which produces a crude, but still quite deadly grade of toxin.

Preparation of the Toxin

When cleaning the fish, always wear good rubber gloves. Cut off the head and carefully peel back the skin, like a glove, from neck to tail. The internal organs will drop out. Pick out the liver, intestines and gonads (see illustration) and discard the rest of the fish.

Crude Extract

1) Grind the organs in a blender, place in a percolator, and extract for 5 hours, adding more water as needed.

-
- 2) Concentrate the liquid extract under vacuum.
 - 3) Dissolve the residue in the minimum amount of hot alcohol and filter while hot.
 - 4) Cool the alcohol in a refrigerator overnight. The toxin will precipitate as a yellow powder.

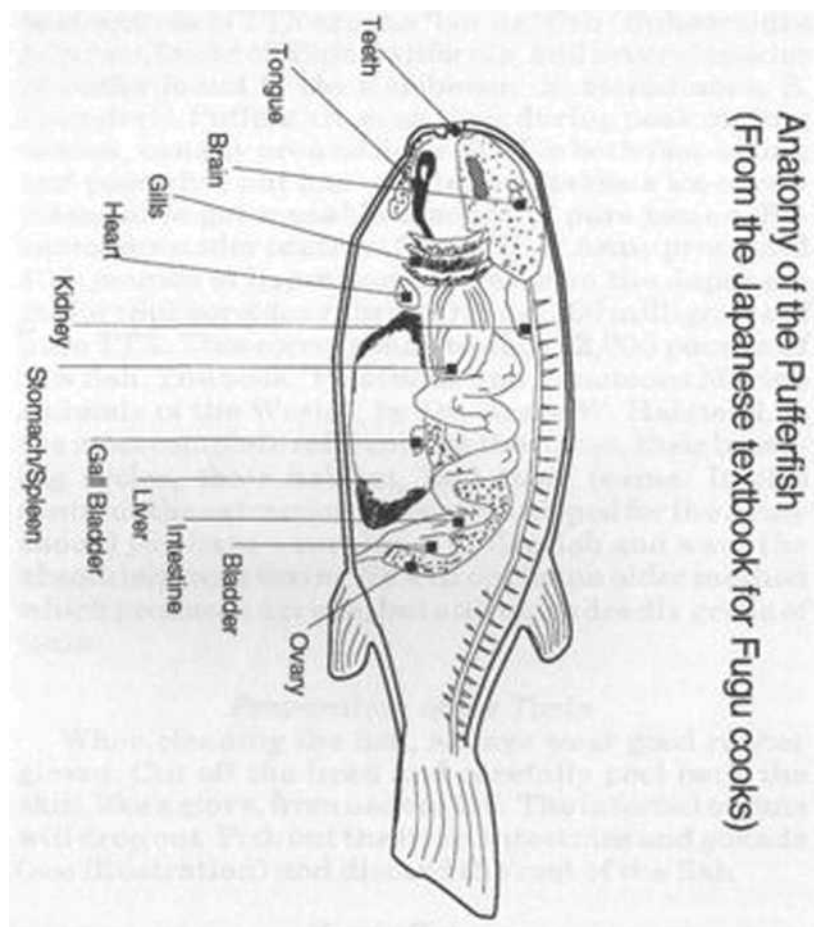

Anatomy of the Pufferfish
(From the Japanese textbook for Fugu cooks)



S-(2diisopropylaminoethyl)0- ethylmethylphosphorothiolate.

SOURCE - Chemical synthesis.

FORM - Heavy, oily liquid like motor oil; Odorless. Clear to straw in color. BP 300° C.

HANDLING - Avoid inhalation, ingestion, or skin contact. Handle only in a sealed glove box with decontamination apparatus. A good military mask and decontamination suit should be available.

DOSAGE - Skin - 10mg. Orally -2mg. Inhalation - 10mg.min/cubic meter. VX has a very low vapor pressure and therefore is very slow to evaporate. The primary danger is from skin contact or ingestion, though it is very toxic as an aerosol.

SYMPTOMS - Dim vision, pinpoint pupils (may not occur from skin absorption), runny nose, tightness of chest, sweating, muscular twitching, nausea, vomiting, weakness and coma. Vapor inhalation or absorption of vapor through the eyes causes quickest onset of symptoms. Skin absorption generally takes about 10 minutes.

DETAILS - VX, like most other nerve gases, originated from insecticide research, which in this case, was done in Britain in the late 1950's. Unlike Sarin, VX is a persistent agent - meaning it can stay on target

and active for weeks at a time (assuming proper weather conditions). This property also gives VX a much lower skin dosage than Sarin, as it will not evaporate before being absorbed. Mixing 50/50 VX and DMSO gives a liquid which absorbs through the skin in 2 to 3 minutes. DMSO both accelerates absorption and increases toxicity in organophosphorus compounds such as nerve gas. In the 1950's the Soviets experimented with a 50/50 mixture of DMSO and Soman (their standard nerve agent). They found the dose to be 1/6th as much as the pure agent.

Preparation of VX

1) 1000ml of anhydrous ethyl ether and 234 grams of re-distilled dichloromethylphosphine are added to a 3 liter reaction flask which has been previously flushed with dry nitrogen.

2) A mixture of 152.4ml (193.2g) of absolute ethanol and 583.1ml (627g) n, n-diethylaniline are placed in a dropping funnel and added dropwise with stirring to the mixture from step 1. During this addition maintain the reaction temperature at 20° to 30° C by use of an ice bath, and flush dry nitrogen through the system. The exit gas line from the condenser is connected to a mercury bubbler.

3) After the alcohol addition is completed, continue stirring for an additional 3 hours.

4) Remove the flask from the reaction apparatus and flush with nitrogen.

5) Pour the contents of the flask into a Buchner funnel and rinse the flask with 300 ml of anhydrous ethyl ether. Pour this into the funnel. Filter with vacuum from an aspirator equipped with a dry ice/acetone trap. Wash the filter cake with two 300ml portions of anhydrous ethyl ether. The filter cake is X, n-diethylaniline hydrochloride and is not used in this process. It may be saved and converted back to its original form for reuse.

6) The liquid reaction product is transferred to a 2 liter flask which has been previously flushed with dry

nitrogen. Connect the flask to a 10 inch packed column with a stripping head and distill off the ethyl ether at a temperature of about 60° C. The exit gas line is sealed with a mercury bubbler to preclude the entrance of atmospheric oxygen into the system.

7) The remaining liquid is transferred to a 500ml flask and distilled in vacuum at 47°C/50mm. Yield is about 223.2 grams of diethyl methyl phosphonite.

8) The 223.2 grams of diethylmethylphosphonite is placed in a 1 liter flask fitted with a thermometer and a condenser, and mixed with 119.6 grams of 2-diisopropylaminoethanol.

9) Flush the flask with dry nitrogen and slowly heat from 23° to 110°C over the course of 55 minutes. Ethanol will begin distilling at 75° to 78.5° C. Continue a further 65 minutes to remove all ethanol. The temperature will reach 150°C at completion. Yield should be about 37.4 grams of ethanol.

10) Discontinue heating and flush dry nitrogen through the system while it cools to 50°C.

11) Fractionally distill under vacuum. The desired product, ethyl 2-diisopropylaminoethyl methylphosphonite, will distill at 54°C/100. Yield is about 136.8g. (Note - One of the original feed-stocks, diethylmethylphosphonite distills at 48°C/50mm. This fraction should be saved for reuse. Almost half (45%) may be recovered in this way.

12) Equip a 3 neck 1 liter flask with an agitator, a thermocouple well, an addition tube for the sulfur with a vibrating feed, and an addition line for nitrogen. The flask is immersed in a bath of ethylene glycol contained in a battery jar. Cooling is controlled by adding dry ice to the bath and heating, by a submerged electric heat coil.

13) Pour the 136.8 grams of ethyl 2-diisopropylaminoethylmethylphosphonite into the flask and start a nitrogen purge to maintain an inert atmosphere.

Assorted Nasties

14) Use the vibrating feeder to slowly add 18.5 grams of ground rhombic sulfur. Allow 60 minutes to feed the sulfur. The reaction is kept at about 30°C with the dry ice/glycol bath.

15) 10 minutes after the last of the sulfur has been added, heat the flask as quickly as possible to 120°C, using the heating coil. and maintain at this temperature for 90 minutes.

You now have about 155 grams of S-(2-diisopropylaminoethyl)-0-ethyl methylphosphonite (VX) of 97.6% purity. Use it wisely.

NOTE - Do not attempt this process unless you are well versed and experienced in conducting reactions and distillations in inert atmospheres, and aware of the natures of the chemicals used. If you do not, you are courting disaster.



The most potent toxin in the world is of little value without an efficient delivery system. If you can't get what you have where you want it, in a form which will take maximum advantage of its lethal properties, your ultra-potent substance is worthless. The type of delivery system utilized may be as simple or as complex as operational conditions and your level of technology allows. On one end of the spectrum is the technique formerly used by the Ottomac Indians in Guiana, who would grow their thumbnails long, sharpen them and coat them with curare. It made a formidable close-quarters weapon. At the other end of the spectrum is the CIA silent dart gun, which fired a tiny, hair sized dart that dissolved in the body. The type of target would also influence the choice of delivery system to use, as would the nature of the chemical toxin. Volatile liquids, such as chloracetone or HCN can be delivered by hand-thrown glass bottles if intended as an area weapon, or by squirt bottle for individual contamination. The war gases, such as Sarin, VX, or Mustard may be delivered by the technique of explosive dissemination, if meant as an area weapon. This technique is the fastest way to rapidly contaminate an area with toxin. The explosion causes the filling to break up almost instantaneously, thereby

causing it to vaporize more quickly. The U. S. Army M-1 chemical mine is a simple 1-gallon can containing VX or Mustard gas. Dissemination is achieved by a 5-foot long piece of detonating cord coiled under the can. In this case, little of the chemical agent is actually vaporized; instead it is spread over the area as a contact contaminant and evaporation hazard. Persistent agents, such as the aforementioned two, can contaminate an area for weeks or even months at a time, if the weather is cold enough to retard evaporation and there has been no rain. The common hypodermic syringe can be a very versatile tool for delivering toxins. Stock hypos may be carried in the pocket disguised as pens. A Ice tuberculin syringe is the easiest to modify, as it is thin enough to fit most common pen caps over the end of its plunger. Some shimming may be necessary.

One of the simplest ways of delivering volatile liquid toxins is to use a nasal spray squeeze bottle. They are readily available, cheap, and pocket sized. Robert Mainhardt, one of the main designers of the legendary Gyrojet rocket gun as well as the CIA dart gun, patented a squeeze bottle tear gas weapon with an attached squeezer flashlight for night encounters. After filling the bottle you should plug the nozzle with a dab of Vaseline to prevent leakage. The kind of bottle with the flip-top cap is preferred, as it can be put into operation with one hand.

Another simple delivery system is a common child's water gun. A big problem is the fact that most of the samples on the market are, quite simply, junk. The newer motorized ones would be nice, but they are either just too large or look too much like firearms. That just wouldn't do. The main points to consider when choosing a water-gun are -

DLeakage - The only place liquid should come out is the nozzle. You can seal up the loading port after filling, but any other leakage is totally unacceptable.

2) Volume of delivery - This is how much liquid

squirts out per trigger pull. The volume is more important than the range of the squirt, since they are usually employed at point blank range, directly into the face of the victim. More than one pull of the trigger will likely be needed.

3) Is priming required? Some models require several pulls of the trigger or other manipulations before delivery begins. For obvious reasons, this is unacceptable.

As with the squeeze bottle, the nozzle should be lightly plugged with Vaseline. A handy pocket-sized squirt gun can be made from a common syringe and a few household items. Cut a slot into each of the finger tabs on the sides big enough for a wide rubber band. The rubber band is stretched across the end of the plunger and secured to both tabs. A notch is cut into the plunger for the trigger lever. This lever is made from flat stock, about 3/8" wide. It is held to the syringe body by a couple of turns of mechanic's wire. This will also act as a pivot for the trigger. No details of construction are really necessary, just consult the illustration. Test to see if the nozzle is of the proper size to deliver your intended load. You can ream it out to unload more quickly, or constrict it if a longer range is desired. Plug as before with Vaseline.

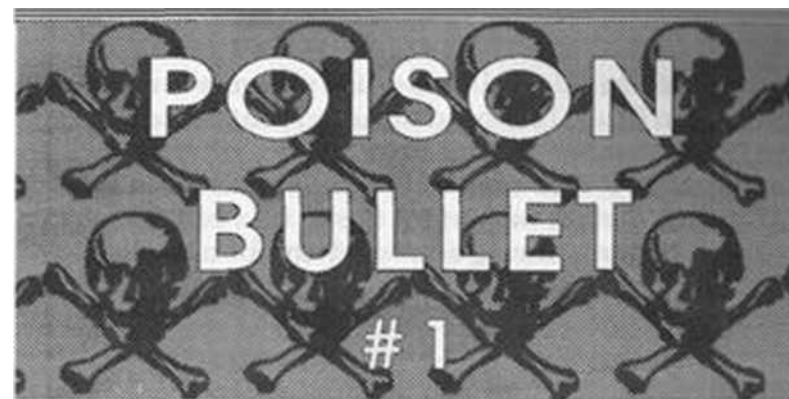
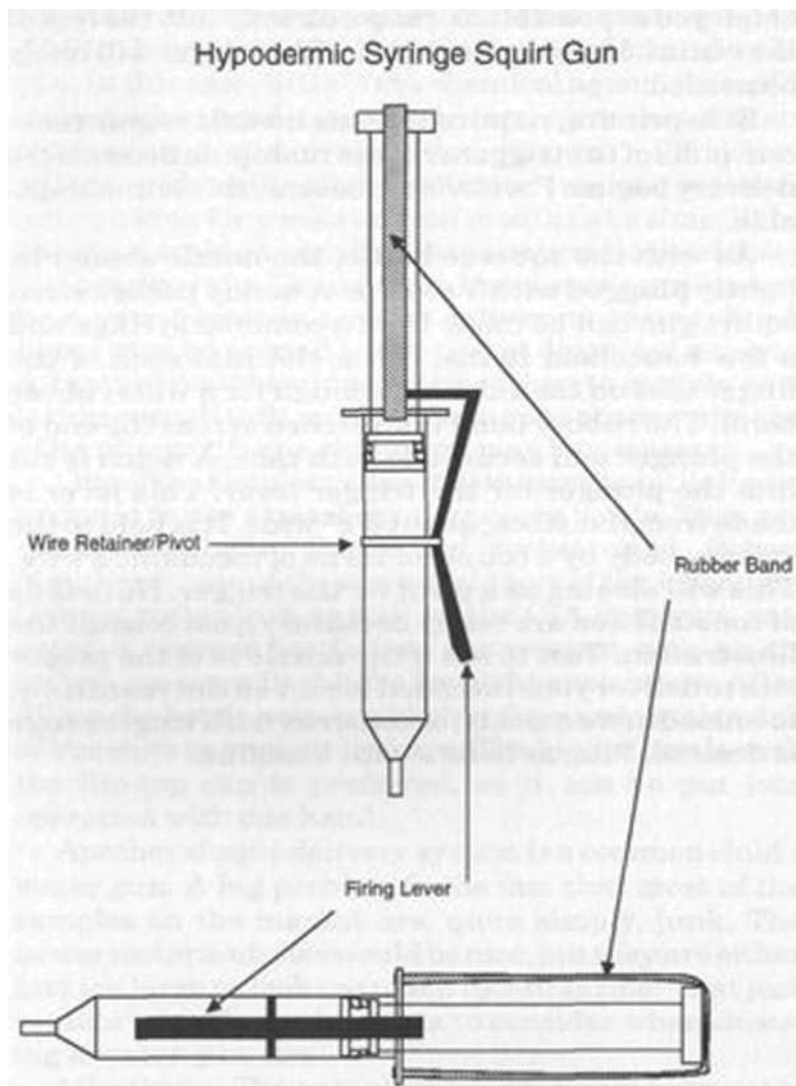

An efficient toxic projectile may be made with a few simple modifications of a commercial jacketed hollow-point round. This is a simplified version of a similar round used by the Soviets in WWII. It is designed for the .38/9mm cartridge but will work on most others with adjustments for size.

Step One • Enlarge the hollow point of the bullet using a 1/8th inch drill bit. Drill until the bottom of the jacket is reached. Take care not to pierce the jacket.

Step Two-Using a 1/4th inch ball grinder bit, drill a hemispherical seat into the nose of the bullet.

Step three - Use a jeweler's saw with a fine blade to divide the jacket into quarters. Cut all the way down the bullet to the cartridge case. Take care not to nick the case. Seal these cuts with lacquer.

Step Four - Pack the hollow under the hemispherical seat with the toxin of choice.

Step Five- Carefully paint the inside of the seat with adhesive.

Step Six - Seat a 1/4th inch ball bearing in place and seal around the edges with lacquer when dry.

NOTE - On impact the ball will slam back into its seat, forcing the four quarters of the nose jacket to open and spreading the payload throughout the wound. The sharp edges of the jacket will cause additional

Assorted Nasties

damage since this bullet is quite potent even without the poison filler. It should be noted that poison bullets are illegal under federal law.

The BATF has also ruled that since this type of bullet has a steel ball in its nose, it is considered an armor-piercing handgun round and hence, illegal. It is unlikely that this bullet is capable of piercing body armor.

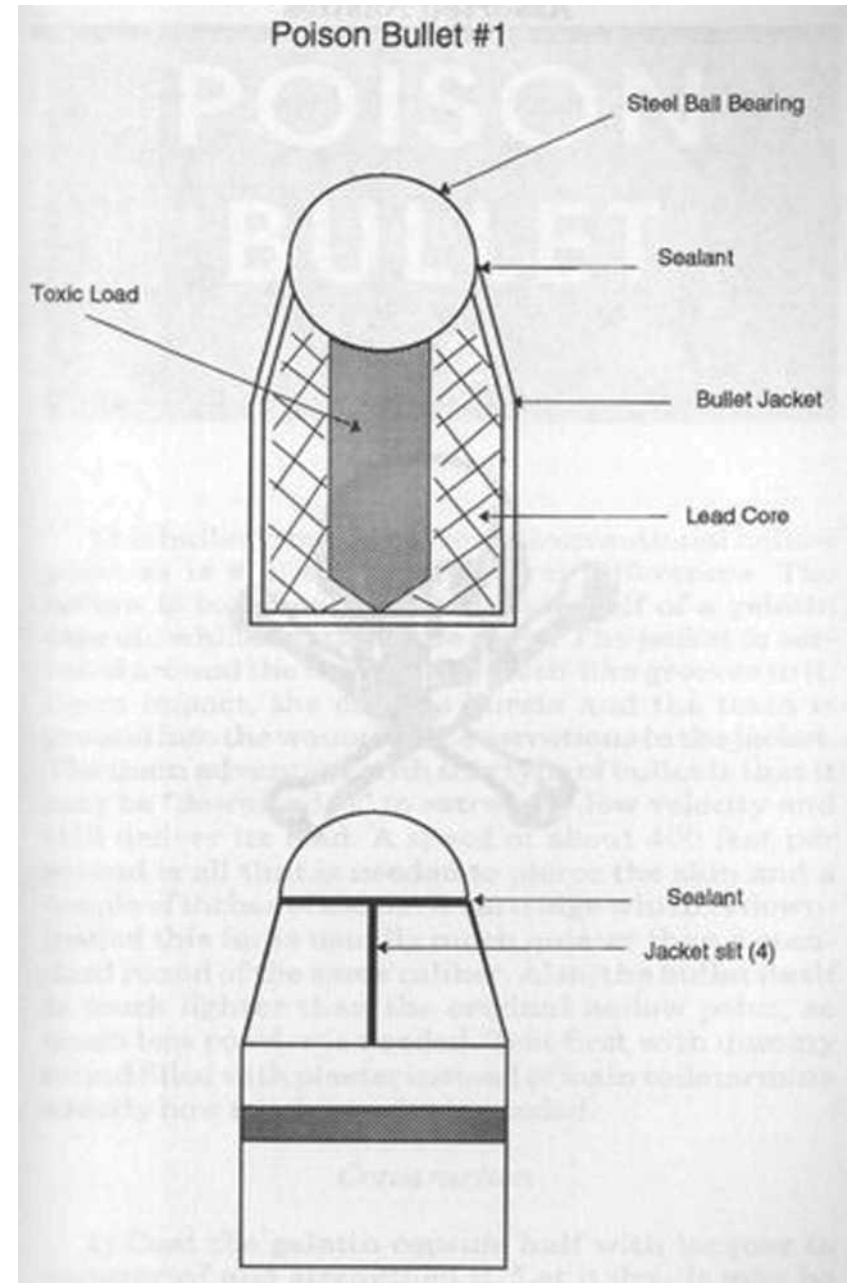

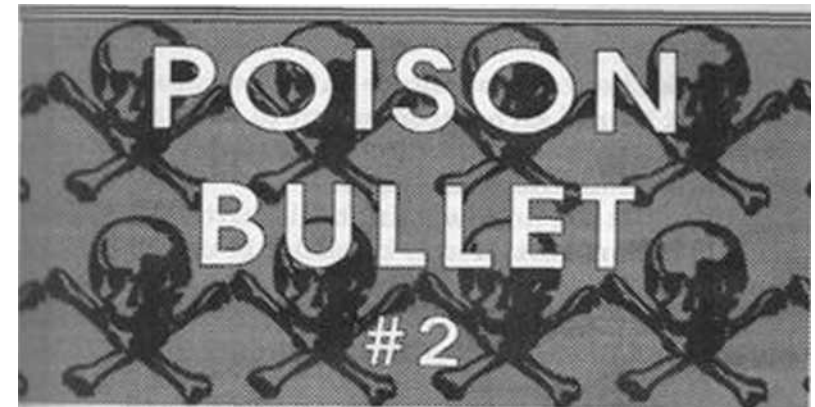

This bullet is modified from a conventional hollow point as is # 1, but with several differences. The hollow is bored out to receive one half of a gelatin capsule which contains the toxin. The jacket is serrated around the top by filing teeth-like grooves in it. Upon impact, the capsule bursts and the toxin is ground into the wound by the serrations in the jacket. The main advantage with this type of bullet is that it may be "downloaded" to extremely low velocity and "till deliver its load. A speed of about 400 feet per second is all that is needed to pierce the skin and a couple of inches of tissue. A cartridge which is downloaded this far is usually much quieter than a standard round of the same caliber. Also, the bullet itself is much lighter than the original hollow point, so much less powder is needed. Test first with dummy round filled with plaster instead of toxin to determine exactly how much powder is needed.

Construction

1) Coat the gelatin capsule half with lacquer to waterproof and strengthen it. Let it dry. It may be necessary to trim its length a bit. Measure the diameter of the coated capsule.

Assorted Nasties

2) Pack the toxin of choice into the capsule. You may want to add an anticoagulant to keep the blood flowing. It may help to dampen the powder slightly to aid compaction, then dry it out.

3) Bore out the hollow point bullet with the appropriate sized drill bit. It may be easier to use a smaller bit at first, then work your way up to the proper size.

4) Hold the drilled bullet upside down and slide the capsule into place. Seal with epoxy.

Note - It is usually best to load the bullet into the cartridge case before modifying it. The completed poison bullet may be damaged if you try to load it in the loading press. For very large capsules, you may want to use one of the "half jackets" used by handloaders who swage their own bullets. The completed bullet will be extremely light, since there will be no lead at all in the jacket. These cartridges will not function in an autoloading pistol because of the tiny powder charge. They are best used in revolvers or derringer-type pistols.

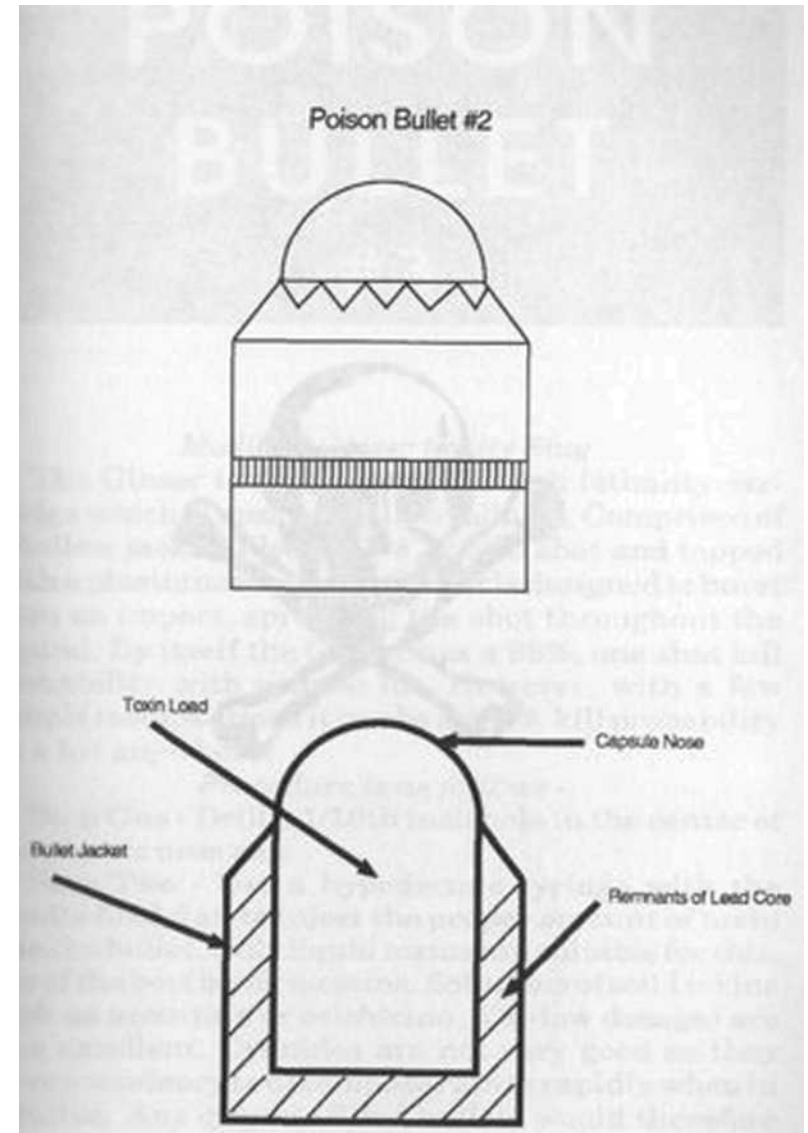

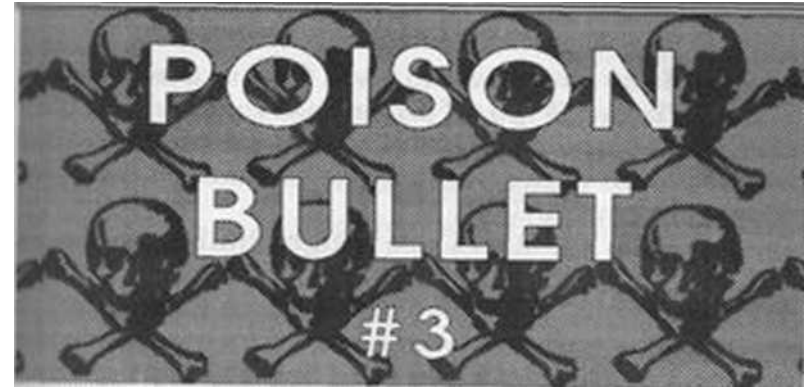

Modified Glaser Safety Slug

The Glaser is a high velocity, high lethality cartridge which is commercially available. Comprised of hollow jacket filled with # 12 bird shot and topped with a plastic nose cap, the Glaser is designed to burst open on impact, spreading the shot throughout the wound. By itself the Glaser has a 98%, one shot kill probability with a torso hit. However, with a few simple modifications it can be a 100% kill probability on a hit anywhere.

Procedure is as follows -

Step One - Drill a 1/16th inch hole in the center of the plastic nose cap.

Step Two - Use a hypodermic syringe with the needle filed flat, to inject the proper amount of toxin into the bullet. Only liquid toxins are suitable for this, one of the best being nicotine. Solutions of solid toxins also as aconitine or colchicine (i.e.-low dosage) are also excellent. Cyanides are not very good as they have a tendency to decompose rather rapidly when in solution. Any cyanide-filled bullets would therefore have an uncertain shelf life. To make the solutions needed from a powdered poison, measure the dose of powder into a test tube and add the appropriate solvent drop by drop until all of the powder is dis-

Assorted Nasties

solved. Make sure that this will fit into the bullet.

Step Three - Wipe off any excess toxin which may have spilled and seal the hole with a drop of lacquer or nail polish (Note - Red is the customary color for poisoned ammunition).

NOTE - Glasers use a light bullet driven at high velocity. Any significant increase in weight could cause excessive chamber pressure to develop. Use caution. The only one I can recommend as safe is the modified .38 Special when fired in the .357 Magnum, The .357 will easily handle the pressures developed by the .38 cartridge.

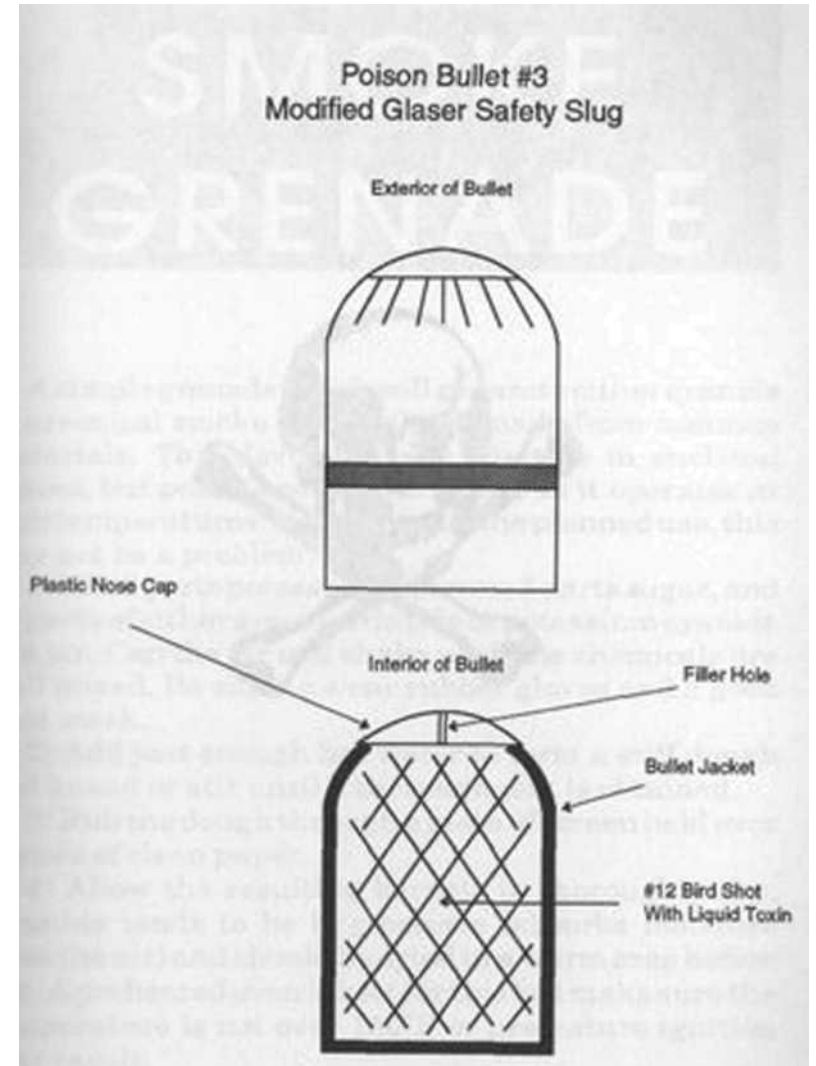

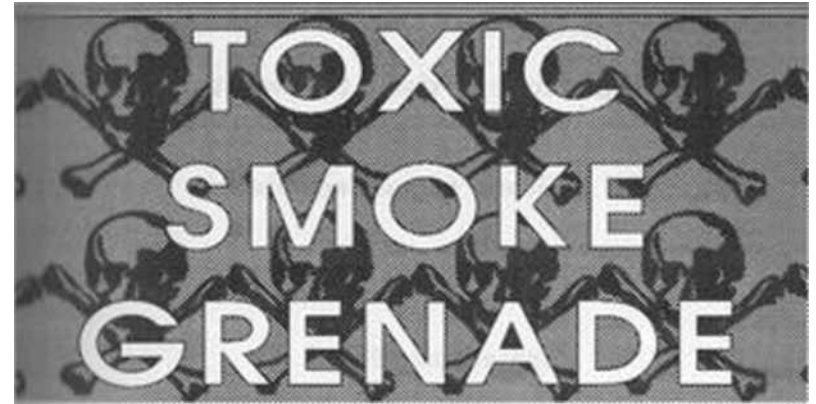

A simple grenade which will generate either cyanide or arsenical smoke can easily be made from common materials. This device is very effective in enclosed spaces, but poses a serious fire risk, as it operates at high temperatures. Depending on the planned use, this may not be a problem.

1) Mix 5 parts potassium chlorate, 5 parts sugar, and 10 parts of either arsenic trioxide or potassium cyanide in a jar. Cap the jar and shake until the chemicals are well mixed. Be sure to wear rubber gloves and a good dust mask.

2) Add just enough hot water to form a stiff dough and knead or stir until a thorough mix is obtained.

3) Hub the dough through a piece of screen held over a piece of clean paper.

4) Allow the resulting kernels to thoroughly dry. Cyanide tends to be hygroscopic (absorbs moisture from the air) and should be dried in a warm area before use. A preheated oven is best for this but make sure the temperature is not over 150°F or premature ignition may result.

5) Pack the dry kernels into a suitable tin can, add the ignition packet (a small bag containing a few grams of 50/50 potassium chlorate and sugar, and a fuse cord), and close the top with a cardboard disk. Seal with tape.

**Toxic
Smoke Grenades**

Assorted Nasties

To use - Light fuse cord and throw into target. May also be ignited by a few drops of concentrated sulfuric acid.

NOTE - Store in sealed plastic bags until needed.

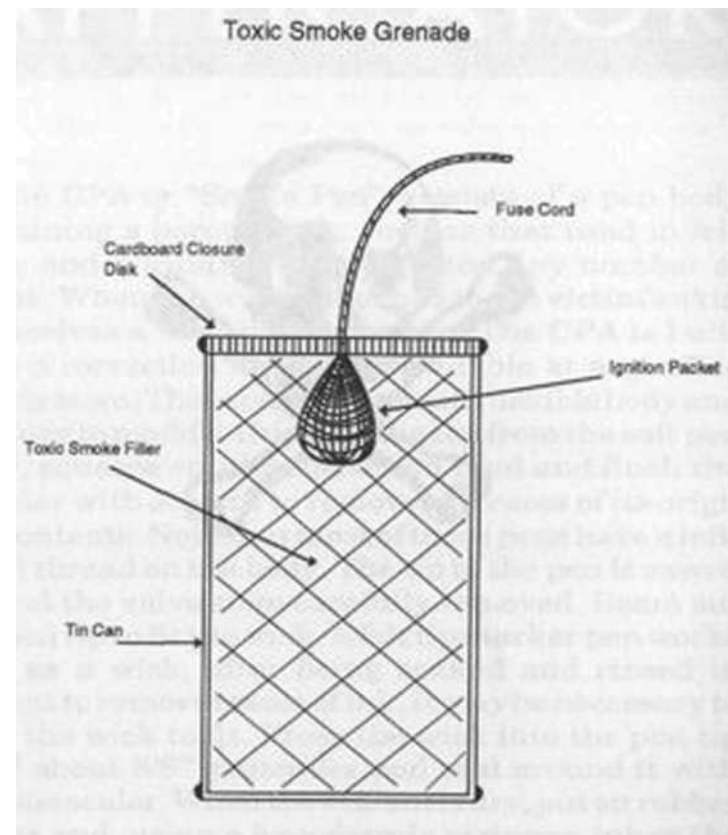

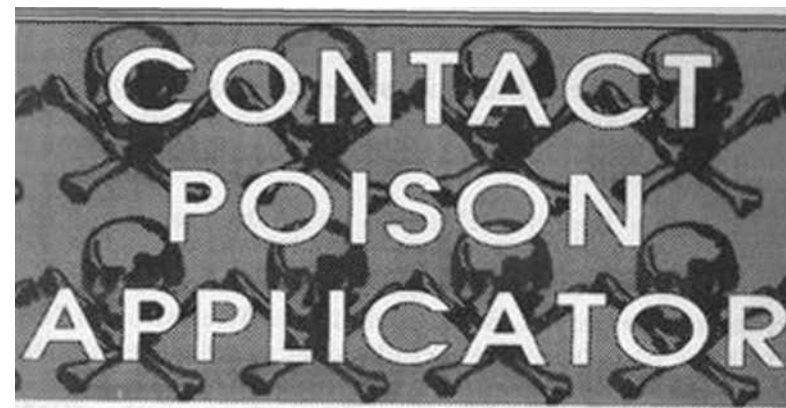

The CPA or "Snake Pen" consists of a pen body containing a porous wick, such as that used in felt pens, and a solution of DMSO and any number of toxins. When the wick is touched to the victim's skin he receives a fatal dose of poison. The CPA is built from a correction fluid pen, available at any office supply store. These pens have a soft, flexible body and are easy to modify. Unscrew the top from the soft pen body, squeeze out the correction fluid and flush the interior with solvent to remove all traces of its original contents. Note that most of these pens have a left-hand thread on the body. The tip of the pen is sawed off and the valve stem carefully removed. Ream out the pen tip to fit the wick. A felt tip marker pen works well as a wick, after being soaked and rinsed in solvent to remove traces of ink. It may be necessary to trim the wick to fit. Press the wick into the pen tip until about 3/8" protrudes and seal around it with silicone sealer. When the sealant is dry, put on rubber gloves and, using a hypodermic syring, inject the DMSO solution into the pen barrel until it is about 3/4 full. Be sure not to squeeze the pen while accomplishing this. Coat the barrel threads with a little silicone sealer, screw on the cap and allow the pen to dry in a vertical position. Line the inside of the cap

Assorted Nasties

with a cylinder of blotter paper to absorb any minor leaks. Since the pen will normally be carried with the wick in an upright position, leakage should be minimal.

To use - Remove the cap with the pen pointing away from your body. Do not squeeze the barrel. Place the tip of the wick on or near the victim's body and squeeze the barrel. Several drops of filler should drip from the wick onto the target. After administering the dose, carefully shake off any loose drops, taking care not to shake them on yourself, and recap the CPA. Dispose of the pen as soon as possible after use, preferably by dropping down a sewer.

NOTE - Be sure to test the completed unit for leakage before using on an operation. The wick should fit snugly, but not leak when held upside down. Place the pen on a sheet of paper in a hot box (body temperature) and leave for a couple of hours. Do this with the pen in several different attitudes. Observe carefully for leaks. It is best to keep the pen stored in a glass cigar tube until it is needed. Remember - any leaks with this weapon while you are carrying it will likely be fatal.

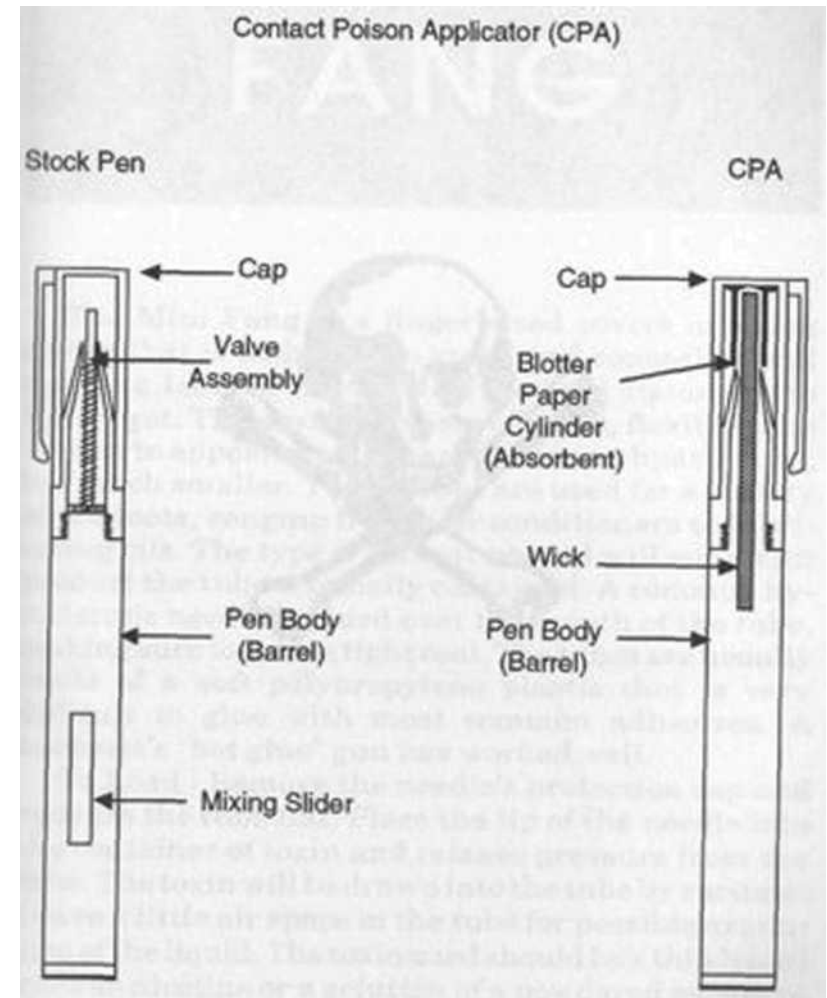



The Mini Fang is a finger-sized covert injection device that is both easy to make and conceal. It will deliver a Ice load of toxin with minimal discomfort to the target. The device consists of a soft, flexible tube similar in appearance to the common toothpaste tube, but much smaller. These tubes are used for a variety of products, ranging from hair conditioners to lubricating oils. The type of solvent needed will vary with product the tube originally contained. A common hypodermic needle is glued over the mouth of the tube, making sure to have a tight seal. The tubes are usually made of a soft polypropylene plastic that is very difficult to glue with most common adhesives. A hobbyist's "hot glue" gun has worked well.

To Load - Remove the needle's protection cap and squeeze the tube flat. Place the tip of the needle into the container of toxin and release pressure from the tube. The toxin will be drawn into the tube by vacuum. Leave a little airspace in the tube for possible expansion of the liquid. The toxin used should be a thin liquid such as nicotine or a solution of a powdered poison in the appropriate solvent. Avoid alcohol, if possible, since this will probably sting quite a bit upon injection.

To Use - Remove the cap from the needle. Jab into the victim's body, possibly using a bump or stumbling

Assorted Nasties

ruse. Immediately squeeze the tube to inject the toxin. Withdraw the needle. Do not release pressure on the tube until the needle is withdrawn to eliminate the possibility of sucking the toxin back in. Dispose of the device as soon as possible, preferably by dropping down a sewer.

NOTE - Being of such small size, the Mini Fang is easy to smuggle into restricted areas. It can be hidden almost anywhere on the body or in commonly carried objects such as a cigarette pack.

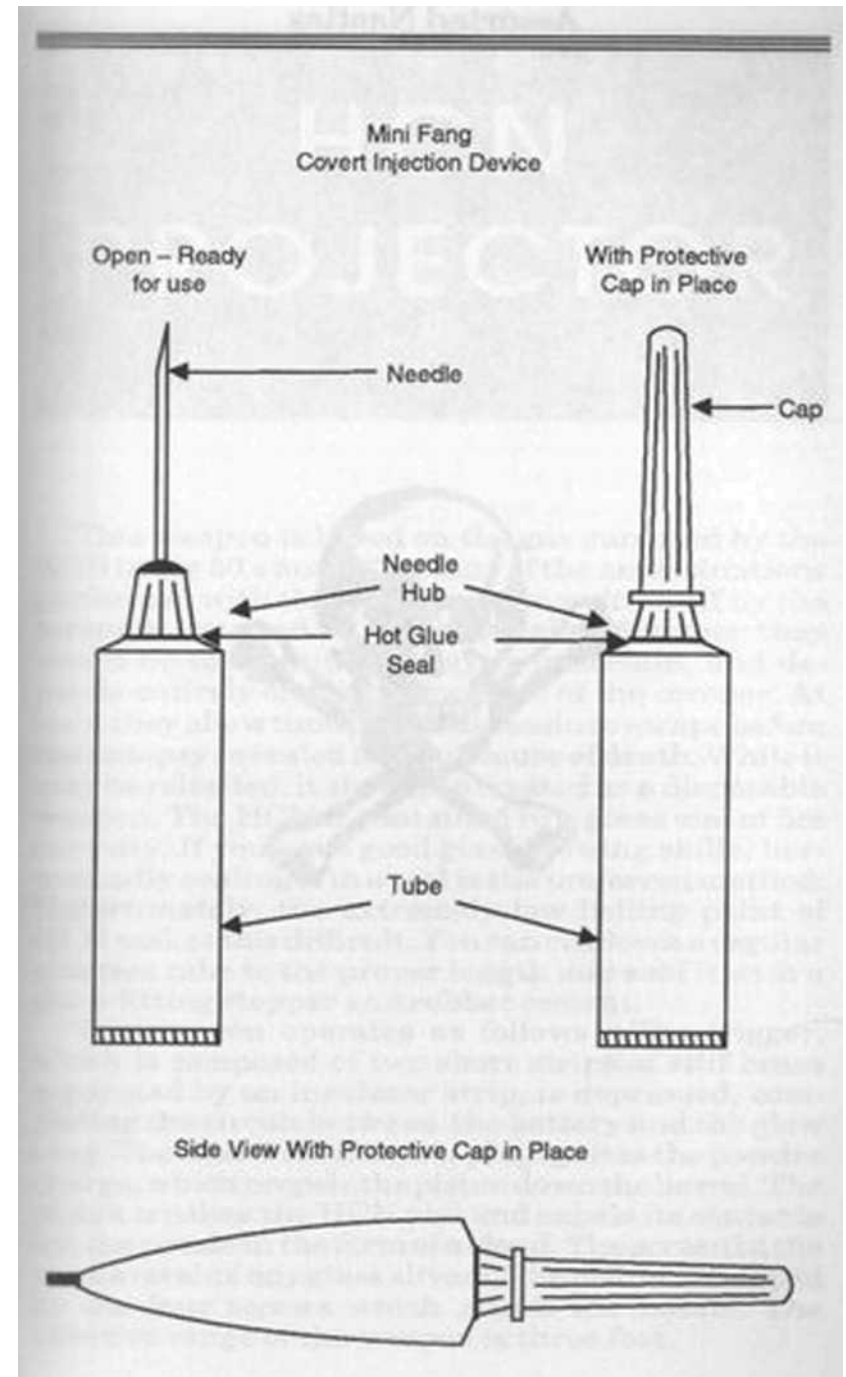



This weapon is based on the gas gun used by the KGB in the 50's and 60's. Many of the assassinations performed with this weapon were written off by the coroners involved as heart attacks. Whether they would be so identified today is uncertain, and depends entirely on the competence of the coroner. At least they allow time for the assassin to escape before the autopsy revealed the true cause of death. While it may be reloaded, it should be treated as a disposable weapon. The HCN is contained in a glass vial of 5cc capacity. If you have good glass blowing skills, hermetically sealing it in a vial is the preferred method. Unfortunately, the extremely low boiling point of HCN makes this difficult. You can cut down a regular size test tube to the proper length and seal it with a close-fitting stopper and rubber cement.

The weapon operates as follows - The trigger, which is composed of two short strips of stiff brass separated by an insulator strip, is depressed, completing the circuit between the battery and the glow plug. The heat from the glow plug ignites the powder charge, which propels the piston down the barrel. The piston crushes the HCN vial and expels its contents but the nozzle in the form of a cloud. The screen in the nozzle retains any glass slivers. The piston is stopped by the four screws which attach the nozzle. The effective range of the weapon is three feet.

Parts list

- 1/2" copper pipe, 8 inches long (projector body)
- 1/8" nominal size steel water pipe, about 2 1/4" long (barrel)
- 1/4" bolt, about 2" long (piston)
- Inner tube rubber (piston pads)
- Model airplane glow-plug (ignitor)
- 6-volt "N" cell battery and battery box
- 1/2" to 3/4" copper pipe reducer (nozzle)
- Small disk of metal screen (nozzle screen)
- 4 small screws (nozzle retainers/break shoulders)
- 1/2" copper pipe cap (end cap)
- 1/4" wide brass strip (trigger wire)
- flash-powder
- double base pistol powder
- Epoxy casting resin
- tape

Construction

Projector Body

- 1) Cut a piece of 1/2" copper pipe to 8" in length. Deburr the ends.
- 2) Fit the 1/2" to 3/4" reducer onto one end of the pipe. Drill four holes at 90° angles to each other through the reducer and the pipe. Their size depends on the size of the screws employed.
- 3) Remove the reducer and press the screen disk into its mouth. Solder in place.

Barrel Unit

- 1) Cut the piece of 1/8" nominal size water pipe to about 2 1/4" long. Square off the ends with a file and ream the inside with a 1/4" drill bit.
- 2) Using a torch and plumbers solder, solder the glow plug into the end of the pipe.
- 3) Solder two wires to the tip and body of the glow plug. Do not allow the wires to touch.
- 4) Check the glow plug by touching the wires to a 1 1/2 volt battery. By looking down the bore of the

pipe, you should be able to see the glow of the filament after a brief delay. This shows that your connections are good. With the 6-volt battery, the filament will light up instantaneously. If left on for more than a moment, it may burn out. All testing should be done with the 11/2-volt, leaving the 6-volt for operational use only.

5) Pour a small quantity of flash-powder into the bore to cover the glow plug. Tap the barrel lightly to make sure that the powder flows into contact with the filament. This is the primer charge. Pour about one grain of pistol powder to cover the primer charge. Tamp in place with a small wad of cotton.

6) Prepare the piston by sawing off the 1/4" bolt to the proper length. With the powder charge and wad in place, the bolt head should extend about 1/4" out of the barrel. Cut four rubber disks from an old inner tube. They should be of the same diameter as the interior of the projector body. Glue them together with rubber cement to form a thick rubber pad. When dry, glue them to the bolt head to form a sort of plunger.

7) Slide the piston into the barrel and tack it into place with a drop of rubber cement.

8) Twist the glow plug wires together. Wrap electrical tape around the end of the barrel until it is the same diameter as the interior of the projector tube. Push the barrel/piston assembly into the projector tube until the tip of the glow plug is about 2" in from the end. It may help to lubricate the plunger and tape with glycerin.

9) Pour epoxy resin into the projector until the glow plug is covered with a layer about 1/2" deep. Make sure the resin flows to completely fill the space around the barrel. Let harden.

10) Solder one of the wires to one of the terminals on the battery box. Solder an additional length of wire to the other terminal.

11) Drill a 1/8" hole through the center of the copper pipe cap and thread the two wires through it.

12) Prepare the trigger switch. This will be made

Assorted Nasties

from two 1/4" wide strips of stiff brass. Glue a strip of 1/8" plastic between them to act as an insulator. Leave about a 1/4" overhang on one end to act as the trigger and about 1/8" overhang on the other end to solder the wires to.

13) Solder the switch to the glow plug wires. Make sure that they do not touch each other.

14) Paint all connections with a thick coat of nail polish. This will insulate them. Spray paint the outside of the projector body for this reason also.

Assembly

1) Tape the switch to the top of the tube. Wrap an additional tape strip between the brass contacts of the switch. Leave a small tab so that you can tear it off quickly. This will function as a safety.

2) Install the 6-volt battery into the battery box. Wrap a strip of tape around the box to hold it in place.

3) Stuff the battery box and any excess wire into the tube and press the cap in place.

4) Slide the HCN vial into the other end. Glue it to the inside of the projector body with a single drop of rubber cement. This will keep it from rattling around. Let the glue dry.

5) Press on the nozzle and screw in the 4 screws. They should protrude into the bore of the tube about 1/8". The weapon is now ready to use.

Operation

1) Remove the tape strip safety.

2) Aim the projector directly into the target's face if you are within 6" to 18" range.

Aim lower for longer ranges. You must be within 3 feet (range from nozzle to the target's face) to be effective. Hold your breath.

3) Press the brass strip trigger to fire.

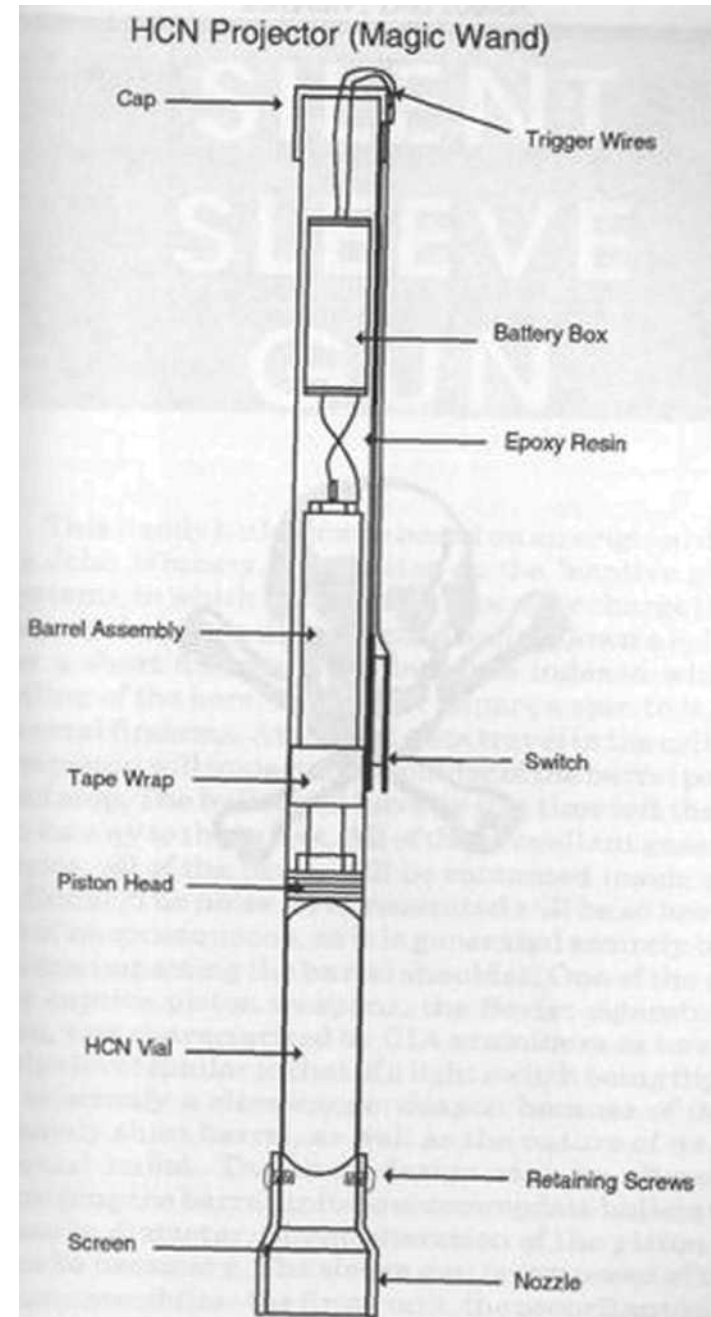



This handy little item is based on an original design by John Minnery. It operates on the "captive piston" systems, in which a fast-burning powder charge is used to propel a piston and attached bullet, down a cylinder for a short distance. The bullet is indexed with the rifling of the bore, which will impart a spin to it, as in normal firearms. At the end of its travel in the cylinder, the piston will impact the shoulder of the barrel portion and stop. The bullet will have by this time left the bore on its way to the target. All of the propellant gases and hence, all of the noise, will be contained inside of the cylinder. The noise level generated will be so low as to be of no consequence, as it is generated entirely by the piston impacting the barrel shoulder. One of the earliest captive piston weapons, the Soviet cigarette box gun, was characterized by CIA examiners as having a noise level similar to that of a light switch being flipped. It is strictly a close-range weapon because of its extremely short barrel, as well as the nature of its very special bullet. The basic design may be altered by changing the barrel units to accommodate bullets up to 9mm in diameter. Slight alteration of the piston may also be necessary. The sleeve gun is composed of three main assemblies - the firing unit, the propellant/piston unit, and the barrel unit.

Firing Unit - This contains a spring-powered striker and trigger lever. It is cocked by drawing back the striker knob until it is engaged by the trigger lever. Pressure on the lever fires the weapon.

Propellant/Piston Unit - This contains the powder charge and piston. One end is bored to fit the powder charge, which is contained in a sawed-off .38 case. The powder charge is poured into the case and a disk of cardboard or plastic is pressed over it to act as a wad. This disk is then covered with epoxy to seal the cartridge. This will allow the pressure within the cartridge to build up before the piston begins its travel. Any size cartridge case which will hold the powder charge may be used, provided it is of smaller diameter than the piston. The amount of powder used will depend upon the weight of the piston/bullet combination. The 7.62 x 88mm cartridge, used in the Soviet two-shot assassination derringer, uses 2.6 grains of a fast-burning powder to propel an aluminum piston and standard 123 grain AK bullet at a velocity of 500 feet per second (estimated). A home-grown 12 gauge cartridge used 6 grains of bullseye to propel a nylon piston/240 grain finned projectile combination to a velocity of 525 feet per second. John's original used about 1 1/2 - 2 grains to propel a modified #4 buckshot at an estimated velocity of 1000 feet per second. This would be a good starting point. You'll need to test the performance of your particular piston/bullet combination. The piston should be as light as possible, while still providing the strength necessary to withstand the gas pressure without fracturing. Aluminum has been used successfully in several variants. I prefer Nylon 6, which may be purchased at any good plastics supplier in 1/2" rod form. It is easily turned on a lathe to the proper dimensions, is light in weight, and has a very low friction coefficient. It is pressed into the large end of the propellant/piston unit, using a close-fitting load-

ing rod. The piston's bottom edge should be chamfered for easy loading and it should fit tightly into the bore of the unit.

Barrel Unit - This portion should be slightly longer than the bullet you are using if a rifle bullet is employed, or twice as long if a pistol bullet is used. The bore is chamfered to insure easy loading of the projectile. The bullet is first tapped through the bore with a close-fitting rod to pre-engage the rifling on it. I used a 69 grain .223 bullet in the test model. Its jacket was extremely thin and would constantly deform at the base when I attempted to tap it through. Success was finally achieved by honing the bore slightly with a piece of emery paper chucked on a rod in a drill. The bore was then cleaned and lubricated, the bullet seated at the mouth, and then slowly pressed through in a vise. When it was completely in the barrel it was tapped out with a rod. The bullet is then ready to modify. A hole is drilled down the point to the base, using a 1/8 " or larger drill bit, depending on the caliber. The toxin is then packed in place and covered with a bit of damp gelatin sheet cut from a capsule. The point should be concave.

Loading and Firing

1) Wipe the bore with a cotton swab lightly dipped in oil. Just a light film is all that is necessary to reduce friction and increase velocity.

2) Push the bullet into the bore until it is fully seated. Cover the end of the barrel with a small disk of masking tape to keep dirt and moisture out.

3) Place the piston on the loading rod and tap it down the large bore of the propellant/piston unit until it is fully seated.

4) Load the cartridge case into the opposite end of the unit.

5) Screw the propellant/piston unit and the barrel unit together.

6) Check the firing unit to make sure that the

trigger lever is engaged in the safety notch of the striker shaft. This prevents the tip of the striker from resting directly on the primer and acts as a safety. Screw the unit to the remainder of the assemblies.

7) Cock the weapon by pulling back the striker knob until the trigger lever engages the sear notch on the striker. It is now ready to fire. The weapon may be concealed up the sleeve and fired by squeezing the lever with your thumb.

Reloading - The sleeve gun is not a rapid-fire proposition. You must wait at least five minutes to allow the propellant gases to cool and reduce in pressure. Slowly unscrew the firing unit from the propellant/piston unit. The gas will begin to leak out. Stop at this point until the hissing stops. You may then fully disassemble the weapon. Remove the propellant cartridge. It probably will be partially dislodged by the gas pressure when you unscrewed it. Use a rod to tap the piston out of the bore and discard it. The piston should not be reused. Clean the weapon as you would a normal firearm.

NOTE - Conventional bullets can work very well in this item. You can get good velocities by carefully adjusting the propellant/projectile combination. Remember that a normal bullet will be much heavier than the fully modified one. The Soviet derringer previously mentioned is believed to have been used in the murder of Nicaraguan Contra leader Enrique Bermudez. No one heard the shots fired and they possessed sufficient power to completely penetrate both sides of his skull. If it was used, this demonstrates a very respectable power level.

Testing Poison Bullets - An excellent method of testing these types of bullets is to use a "Fackler Box". This is a long wooden trough containing many zip-lock plastic bags of water. The expansion a bullet exhibits will be only slightly more than that which would occur in tissue, while the penetration will be

about 1.8 times as much. Cover the end of the trough into which you will be shooting with several layers of tough cloth or a thin layer of wet leather. This will give a good simulation of penetrating clothing and flesh

NOTE - The amount of recoil generated by this weapon will depend upon the weight of the bullet and its velocity. Heavy bullets at high velocity will often give recoil strong enough to kick the gun from your hand. You have three alternatives, as I see it: 1) Let it go to bounce on the ground or jump up your sleeve 2) Add a recoil lug to the piston group. This would be a stout metal tab about 3/4" long which will bear against your finger, allowing them to absorb the recoil, or 3) Use a lanyard attachment for quick recovery.

Silent Sleeve Gun

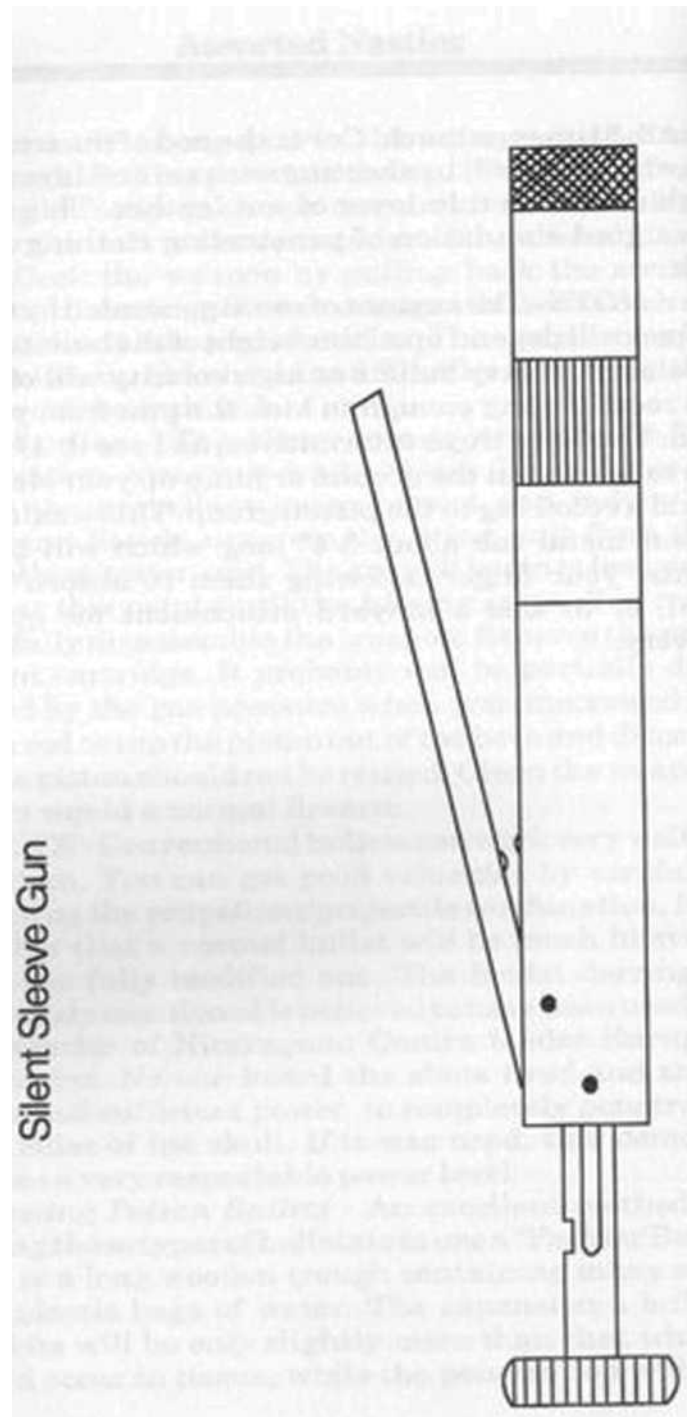

Bullet for Sleeve Gun

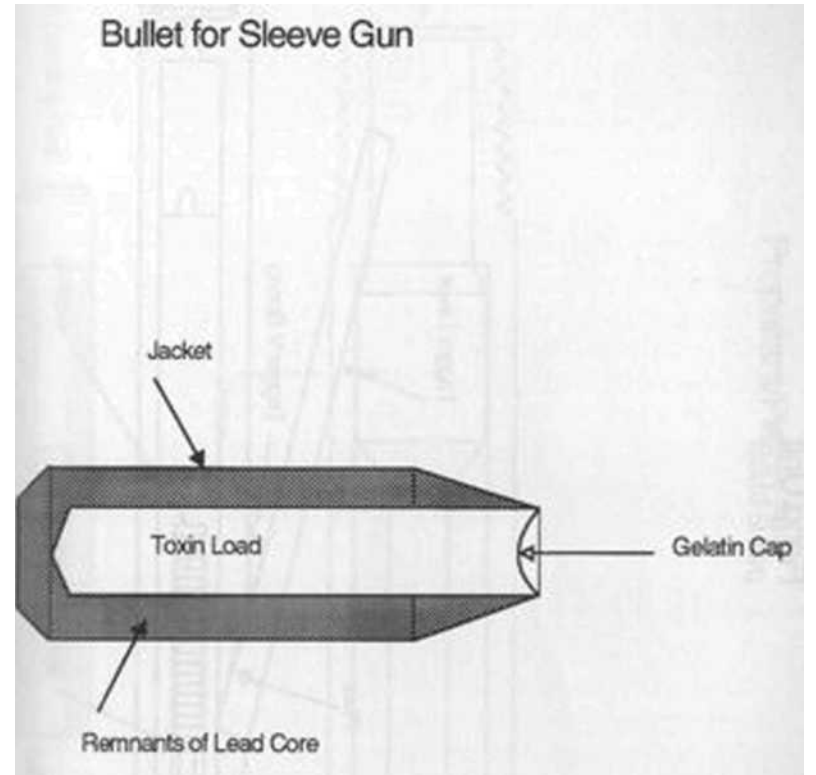

Firing Unit (Not to Scale)

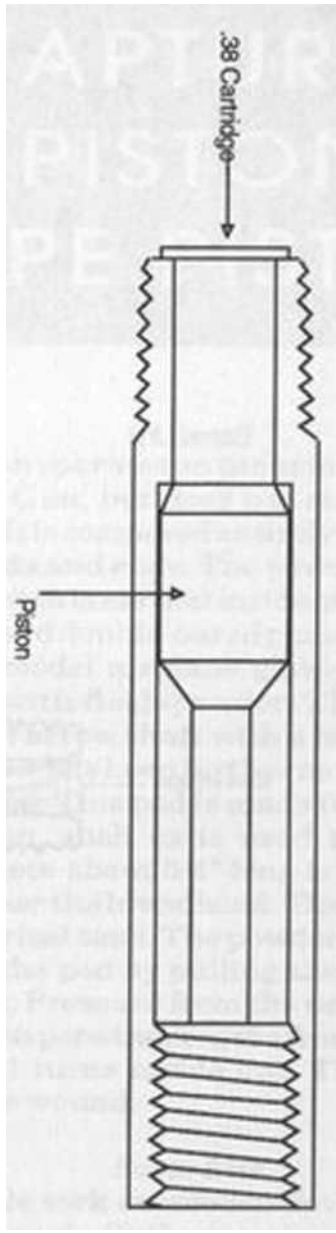
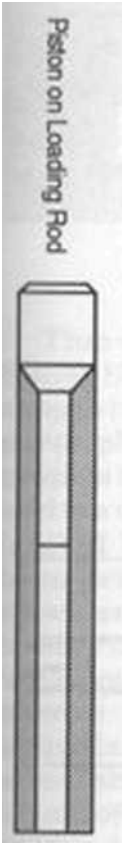
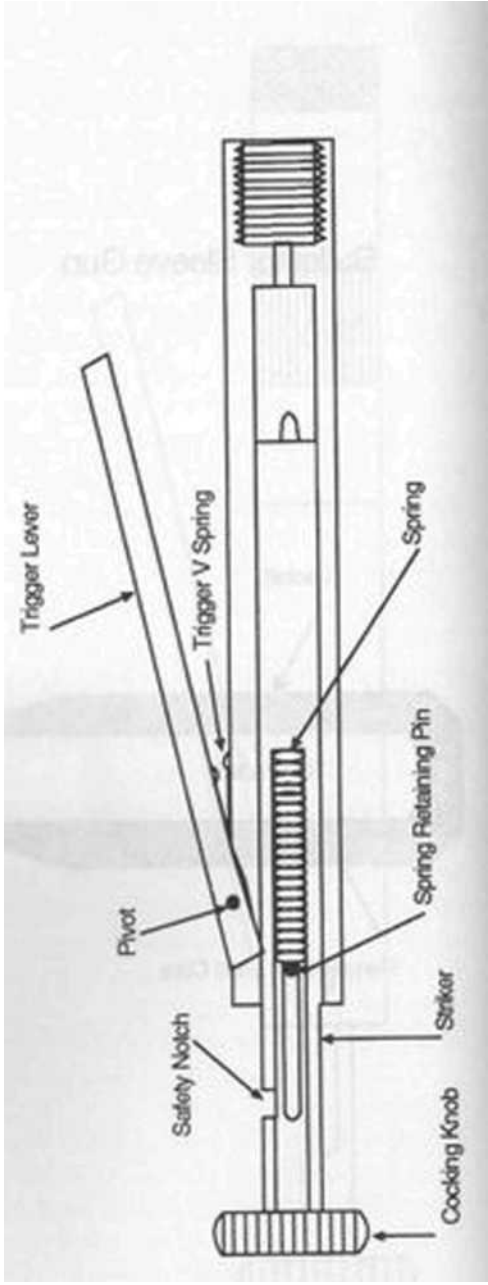

Propellant/Piston Unit

CAPTURED PISTON PIPE PISTOL

Barrel Unit

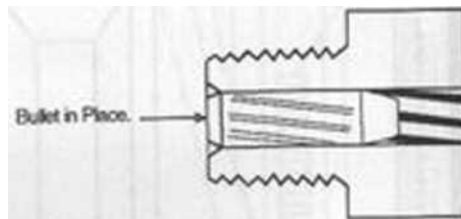
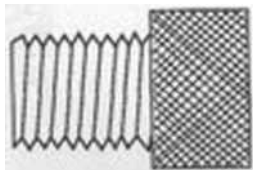

This weapon operates on the same principle as the Silent Sleeve Gun, but does not require a machine shop to build. It is composed entirely of plumbing pipe parts, plus odds and ends. The powder charge which propels the piston is carried inside of the piston itself, and is a standard double-based pistol propellant. It is ignited by a model airplane glow-plug, which has been primed with flash-powder. The projectile is a short length of arrow shaft with a broadhead arrowhead. The arrow has been further modified by attaching a poison pod. This pod is made from the neck of a narrow balloon, such as is used to make balloon animals. A piece about 3/4" long is slipped over the arrow shaft near the broadhead. The rear is closed by a turn of electrical tape. The powder or paste toxin is spooned into the pod by pulling the neck ring away from the shaft. Pressure from the neck ring will hold it in place. Upon penetration, the front edge of the pod rolls back and turns inside out. This deposits the poison into the wound.

Parts List

1 wine bottle cork or wooden dowel, about 1 inch long (should snugly fit the interior of the large pipe nipple after honing).

**Captured
Piston Pipe Pistol**

- 1 3/4" (nominal size) pipe cap
- 1 3/4" x 3" pipe nipple
- 1 3/4" to 1/8" pipe reducer
- 1 1/8" x 1" pipe nipple (only needs threads on one end)
- 1 piece of 1" thick wood, cut in shape of grip
- 2 1 1/2" - 2" hose clamps
- 1 Glow-plug
- 1 Battery and box (must be at least 3 volts)
- 1 single pole, single throw (SPST) push-button momentary switch
- Inner tube rubber
- Arrow
 - 1 metal disk (O.D. same as I.D. of large pipe nipple)

Construction

Closely inspect all of the pipe parts for cracks or flaws. None must be present. Use a file or hand grinder to remove any burrs from the inside lip of the pipe. Place a strip of emery paper on a drill rod, chuck it in a drill, and hone the inside of the large pipe nipple until it is smooth. Bore out the smaller pipe nipple to the diameter of the arrow. Drill and tap a hole in the center of the pipe cap to fit the glow-plug (usually it is 1/4 -32). Hollow out the grip piece to fit the switch, battery, and firing wires. Slot it in the top for the hose clamps. Modify the piston by boring a large chamber at one end for the powder charge. Use rubber cement to glue the metal disk, then the 2 rubber disks to the other end.

Assembly

- 1) Coat the thread with pipe sealer and fully screw the smaller pipe nipple into the reducer.
- 2) Coat the threads on the reducer and fully screw it onto the large pipe nipple.
- 3) Fit the battery box and switch into the grip piece. Thread the firing wires through the small hole in the rear.

- 4) Thread the glow-plug into the pipe cap and screw the cap onto the large pipe nipple.
- 5) Attach the grip to the nipple, using the 2 hose clamps.

Loading

- 1) Remove the pipe cap.
 - 2) Slide the arrow into the barrel. Lightly fill the area around the shaft with fiberglass, dusted with graphite.
 3. Press the piston into the large pipe nipple until it is almost flush with the lip of the pipe. Pour the propellant into the chamber in the piston.
 - 4) Pour the flash-powder into the glow-plug and seal it in place with a piece of cellophane tape.
 - 5) Place a drop of rubber cement between the arrow and the small pipe nipple to prevent it from sliding out.
 - 6) Screw the end cap fully into place.
 - 7) Clip the firing wires to the glow-plug.
- It is now ready to fire.

NOTE - You will notice that there may be some variance in pipe sizes. This appears to be the norm for these items, so carefully inspect each piece before using it. You can adapt the basic design to suit your materials. The pistol should be remotely fired at least once before operational use, to be sure that the gas pressure doesn't cause the pipe to explode. Expect a stiff recoil on firing. The arrow is quite a bit heavier than a normal bullet, and all of the standard factors of firearms recoil generation apply. An excellent non-toxic projectile can be made from 1/4" O.D. steel rod. Sharpen the tip until it looks like a sharpened pencil. Though the rod is unstable in flight, at close ranges it will punch through most soft body armor with ease, presupposing an adequate velocity, of course.

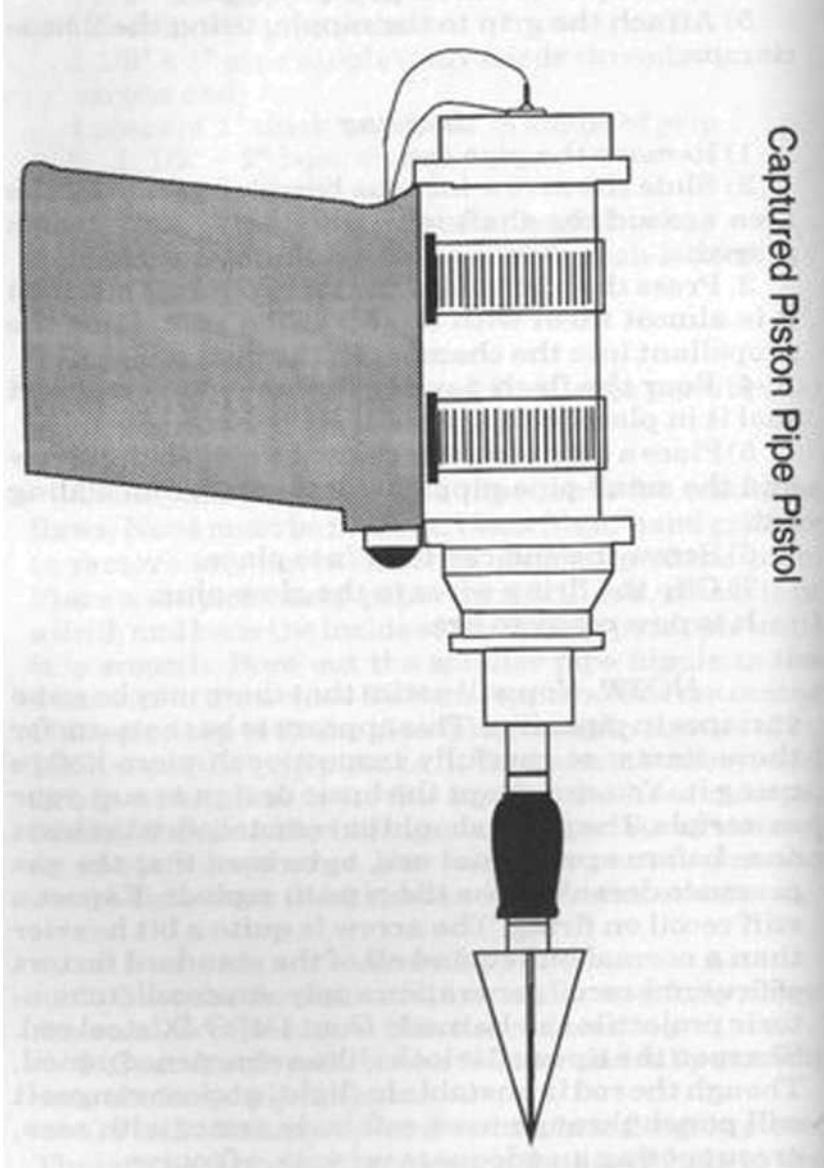

Captured Piston Pipe Pistol

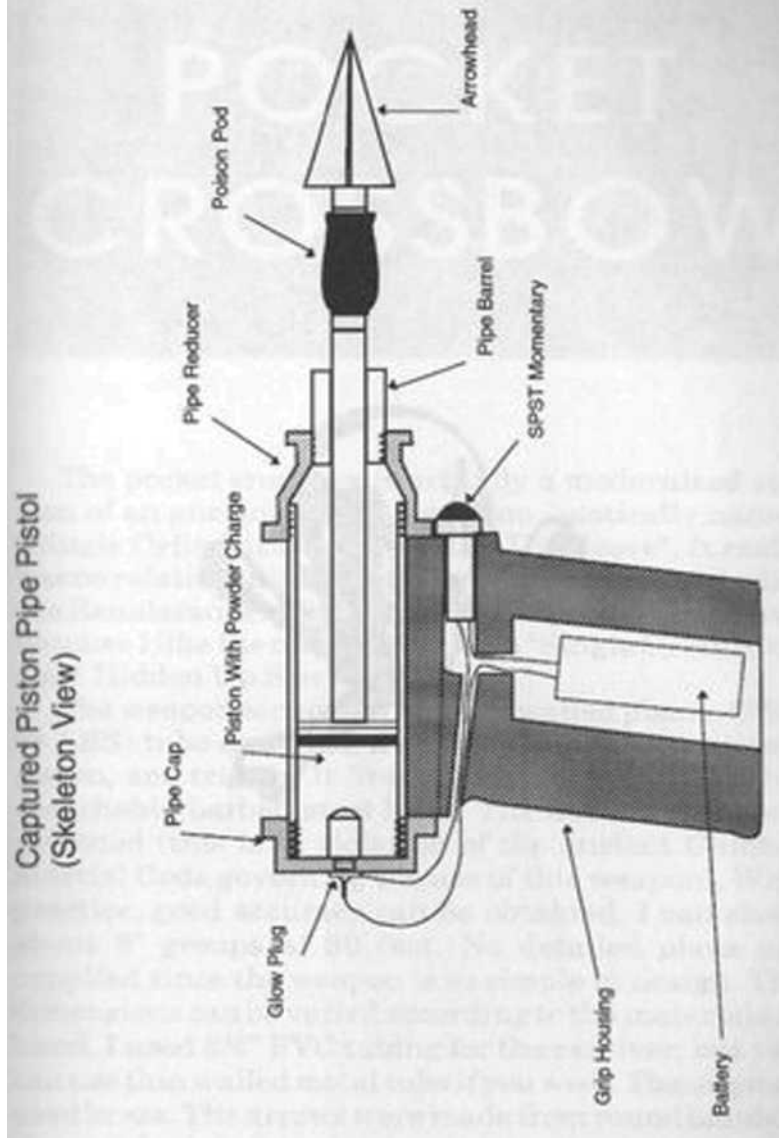

Captured Piston Pipe Pistol
(Skeleton View)

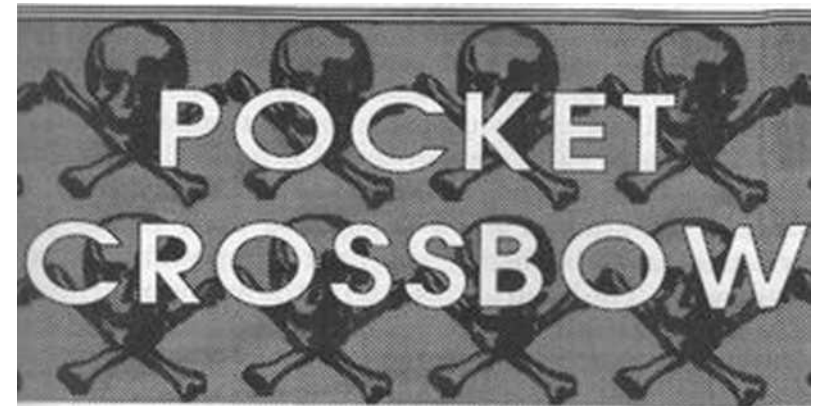

The pocket crossbow is actually a modernized version of an ancient Chinese weapon, exotically named "Single Cylindrical Dart Hidden Up Sleeve". It really has no relation to its namesake, which was used during the Renaissance in Italy. I call it the "pocket Crossbow" because I like the name better than "Single Cylindrical Dart Hidden Up Sleeve".

The weapon consists of a heavy walled plastic (PVC or ABS) tube enclosing a strong compression spring, piston, and trigger. It fires a 5 1/2" long arrow with a detachable barbed steel head. The head is routinely poisoned (this is in violation of the ancient Chinese Martial Code governing the use of this weapon). With practice, good accuracy can be obtained. I can shoot about 6" groups at 30 feet. No detailed plans are supplied since the weapon is so simple in design. The dimensions can be varied according to the materials at hand. I used 3/4" PVC tubing for the receiver, but you can use thin walled metal tube if you wish. The original used brass. The arrows were made from round bamboo chop sticks, but there is no reason you can't use plastic or some similar material. The bamboo arrows work very well, however, and I recommend their use. The heads were made from lengths of coat-hanger wire, heated red hot and hammered flat. The barbs were

Assorted Nasties

carefully filed to shape and sharpened, They were then heated red hot and plunged in oil to temper them. A short piece of yarn was wrapped around the head to accommodate the poison load (see blowgun darts). A simple pin-shaped head should be used for target practice, as the barbed head is next to impossible to pull from wood. The head is attached to the arrow by drilling a hole in the shaft and using a little wax to secure it. The use of wax instead of some other more tenacious adhesive is so that when it is pulled from the wound, the head will remain inside. Play with the design a little. There is much room for variation.

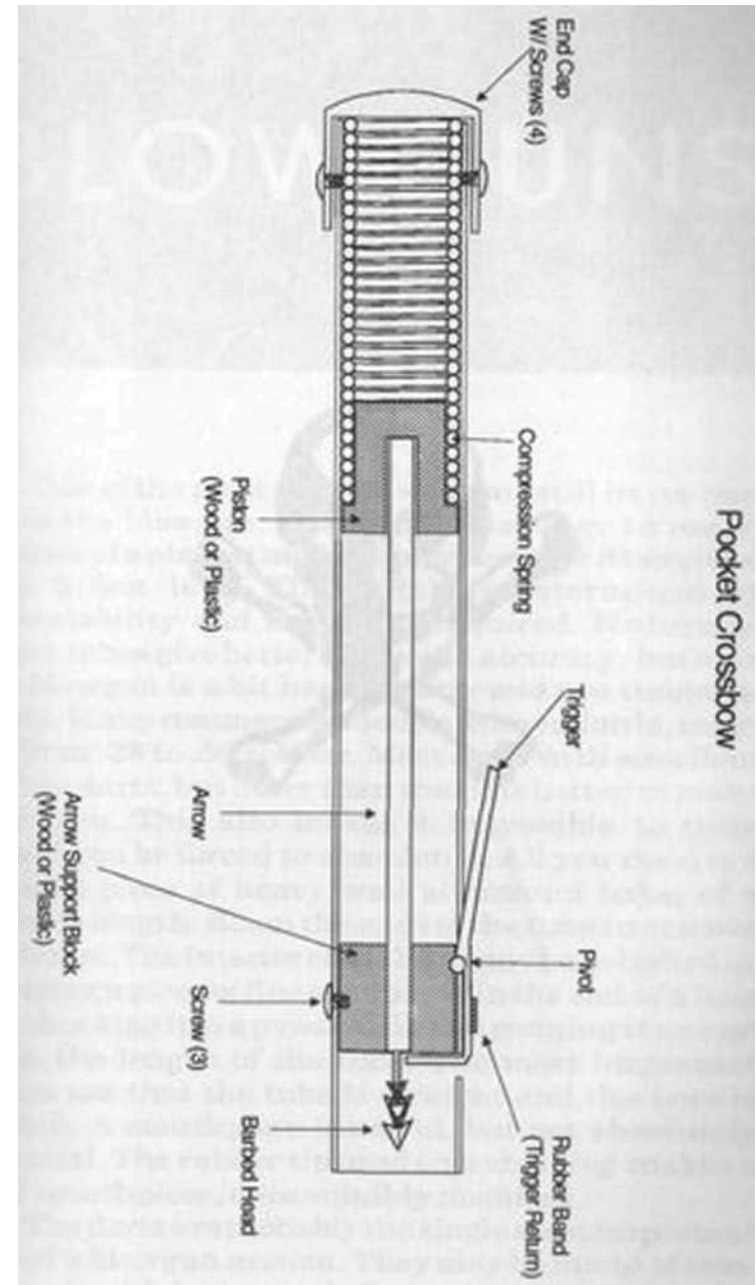



One of the most ancient weapons still in current use is the blowgun. Simple to make, easy to use, it consists of a plain straight tube of metal or fiberglass, 2 to 6 feet long. The length is determined by conceal ability and the range required. Naturally, longer tubes give better range and accuracy, but a six foot blowgun is a bit hard to carry and use unobtrusively. Many commercial models are available, ranging from .38 to .50 caliber. Most come with excellent quality darts, but other than that it is better to make your own. This also makes it impossible to trace should you be forced to abandon it. All you need is a straight piece of heavy wall aluminum tube, of a suitable length. Ream the ends of the tube to remove any burrs. The interior of the bore may be polished by clamping a piece of fine sandpaper in the end of a long rod, chucking it in a power drill, and running it up and down the length of the tube. The most important things are that the tube is straight and the bore is smooth. A mouthpiece is useful, but not absolutely essential. The rubber tip used on a chair leg makes a good mouthpiece, once suitably modified.

The darts are probably the single most important part of a blowgun system. They may be made of wire or wood, with bases made from paper cones, plastic

beads, or golf tees. Steel darts give better penetration, but wood retains the toxins better. It all depends on the materials at hand and the nature and circumstances of your target. The main point is consistency - same type dart, same hold on tube, same measured puff of air. As with rifle shooting, consistency is the cornerstone of accuracy. That, and practice. With practice, you can get excellent accuracy from a well-made gun and darts. Experiment with different dart types and lengths to find which suits you best. Practice blowing the dart out with a hard, quick puff of air. This works better than a long, steady blow.

Wire/Bead Blowgun Dart

These simple, yet effective darts are made from .045 to .062 diameter music wire, which is available at most hobby shops. While you are out, swing by a craft store and pick up some round plastic beads, of a diameter to fit your blowgun, and some polyester yarn. Cut your wire to the desired length, 3 to 6 inches being the most common sizes.. Heat one end of the wire in a flame and plunge it into the hole in the bead. Make sure the wire is properly centered. This is important for top accuracy. That's about all there is to it. This is the basic dart you will use for target practice or small game. For use as a toxin delivery system, a few refinements are in order. Use a dot of superglue to tack one end of a length of yarn to the dart shaft, about 1/4 " from the tip. Wind the yarn tightly around the shaft, like a spool, for the next one inch and tack the end down with another dot of superglue. Cut off any excess. The yarn may then be soaked in liquid or paste toxin. The individual darts must be tested for flight characteristics before using on an operation. If you desire, you can carefully sharpen the dart tip to a needle point, but if not, it is best to leave them flat. These seem to fly

straighter than those with diagonally cut tips, and it doesn't seem to hurt penetration. Remember - they only have to penetrate deep enough to insert the toxin.

Wire/Bead Dart (Exaggerated for Clarity)

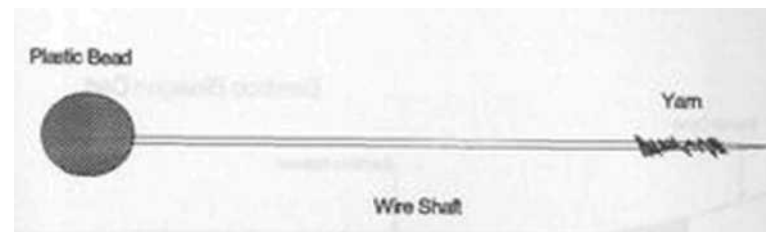

Bamboo Blowgun Darts

- 1) Roll a one-inch long cone of heavy paper, one halfinch in diameter. Glue the cone together and let dry overnight.
- 2) Coat the cone with a clear lacquer spray. Let dry. This waterproofs the cone and makes it a bit more durable.
- 3) Take a bamboo skewer and cut to four inches long. Sharpen the point in a small pencil sharpener. Dip the first quarter inch of the point in epoxy and let dry. This will harden the point. Finish with fine sandpaper.
- 4) File small grooves in the point starting from about a quarter inch from the tip and extending a further inch to the rear. These help retain the toxin.

Assorted Nasties

5) Pierce the tip of the cone with the skewer until only about three-eighths of an inch is left inside. Using a small nozzle, add silicone sealer until the front part of the cone is full, covering the skewer. Let dry.

6) Dart is now ready for use.

7) The dart may be poisoned by dipping in liquid or paste toxin to cover the grooves.

NOTE - All dart dimensions are variable, as materials require.

NOTES

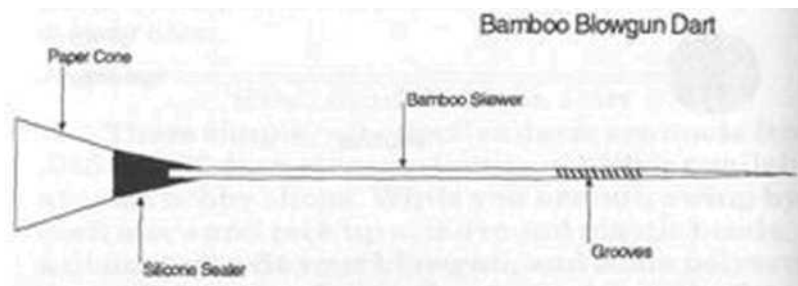



Desert Publications

1970-1971

222 W. Washington

PHOENIX, ARIZONA 85001 U.S.A.

